



COTTO D'ESTE[®]
Nuove Superfici

 dekomart

LA
BELLEZZA
IN
CERAMICA

COTTO D'ESTE
Nuove Superfici

INDICE GENERALE

GENERAL INDEX | INDEX GÉNÉRAL | ALLGEMEINER INDEX

INTRODUZIONE INTRODUCTION

- 006 **LA BELLEZZA COME MISSIONE**
BEAUTY AS A MISSIONE
- 023 **IL NOSTRO GRUPPO**
OUR GROUP
- 028 **LE NOSTRE ECCELLENZE**
OUR EXCELLENCE
- 032 **KERLITE 3plus - 5plus - 6plus**
GRES PORCELLANATO
LAMINATO
LAMINATED
PORCELAIN STONEWARE
- 034 **14 mm**
GRES PORCELLANATO
SPESSORATO
EXTRA THICK
PORCELAIN STONEWARE
- 036 **20 mm**
GRES PORCELLANATO
SUPER SPESSORATO
ULTRA THICK
PORCELAIN STONEWARE
- 038 **SUPERFICI**
SURFACES
- 040 **PROTECT**
SUPERFICIE ANTIBATTERICA
ANTIBACTERIAL SURFACE

PRODOTTI PRODUCTS

- 042 **MARMI E PIETRE**
MARBLE AND STONE
- 170 **MATERIA E COLORE**
MATTER AND COLOUR
- 254 **LEGNI E TERRECOTTE**
WOOD AND TERRACOTTA

APPENDICE TECNICA TECHNICAL BOOKLET

- 304 **GREEN MISSION**
GREEN MISSION
- 312 **KERLITE**
DESTINAZIONI D'USO
INTENDED USES
- 314 **CARATTERISTICHE TECNICHE**
TECHNICAL FEATURES
- 320 **CARATTERISTICHE TECNICHE 14 - 20mm**
TECHNICAL FEATURES
- 324 **CARATTERISTICHE TECNICHE KERLITE**
TECHNICAL FEATURES
- 328 **FORMATI**
SIZES
- 332 **TABELLE CALIBRI**
SIZE TABLES
- 333 **SUGGERIMENTI PER LA POSA**
LAYING SUGGESTIONS
- 336 **GARANZIA COTTO D'ESTE**
COTTO D'ESTE GUARANTEE
- 338 **PULIZIA E TRATTAMENTI**
CARE AND TREATMENT
- 344 **WONDERWALL**
INFORMAZIONI TECNICHE
TECHNICAL INFORMATION
- 346 **CERTIFICAZIONI**
CERTIFICATIONS
- 354 **CONFEZIONI**
PACKAGING
- 356 **DESTINAZIONI D'USO**
INTENDED USES
- 358 **CONDIZIONI GENERALI**
DI VENDITA
GENERAL TERMS AND
CONDITIONS OF SALES

INDICE SPESSORI

THICKNESS INDEX | INDEX ÉPAISSEURS | DICKENINDEX

			kerlite 3plus	kerlite 5plus	kerlite 6plus	14mm	20mm
MARMI E PIETRE MARBLE AND STONE	044	BLUESTONE EVOLUTION					•
	048	BUXY	•			•	
	066	CLUNY (P)	•	•		•	•
	084	ELEGANCE		•			
	092	EXEDRA		•		•	
	110	LIMESTONE		•		•	•
	124	PIETRA D'ISEO			•		•
	132	SECRET STONE				•	•
	144	STONEQUARTZ				•	•
	156	VANITY			•		
MATERIA E COLORE MATTER AND COLOUR	172	BLACK-WHITE	•	•			
	180	CEMENT PROJECT		•		•	•
	198	MATERICA		•			
	210	METAL		•			
	216	OVER	•				
	226	WONDERWALL	•				
	244	X-BETON				•	•
LEGNI E TERRECOTTE WOOD AND TERRACOTTA	256	CADORE				•	•
	268	CASALI				•	
	274	FOREST		•			
	286	WOODLAND			•		



LA BELLEZZA COME MISSIONE

BEAUTY AS A MISSION | LA BEAUTÉ COMME MISSION | DIE SCHÖNHEIT ALS MISSION

RAGGIUNGERE L'ECCELLENZA SEMPRE ED OVUNQUE, NEL MONDO

Cotto d'Este ispira la propria missione ai valori della bellezza italiana: gusto, eleganza e stile, per vivere il presente ai massimi livelli di eccellenza.

Una passione innata per tutto ciò che è arte e cultura si affianca a una consolidata e profonda tradizione ceramica, passando attraverso una ricerca continua sostenuta da innovazione e tecnologia, per offrire prodotti unici al mondo, che possano rispondere ad ogni esigenza dell'architettura contemporanea.

“ Creare bellezza oggi in Italia significa confrontarsi con un'eredità senza uguali e un presente ammirato nel mondo: uno stimolo costante a puntare in alto e migliorarsi. ”

PAOLO MUSSINI
CEO Cotto d'Este



ALWAYS ACHIEVING EXCELLENCE,
ALL OVER THE WORLD

Cotto d'Este's mission is based on the values of Italian beauty: taste, elegance, and style that bring the highest levels of excellence to our everyday lives.

An innate passion for all that is art and culture is combined with a consolidated and deep-rooted tradition in ceramics, involving continuous research supported by innovation and technology, to offer unique products to the world, which can meet any requirement of contemporary architecture.

“ Creating beauty today in Italy means dealing with an unparalleled heritage and an admired present: a constant stimulus driving us to aim high and to improve. ”

ATTEINDRE L'EXCELLENCE TOUJOURS
ET PARTOUT DANS LE MONDE

Pour la réalisation de ces produits, Cotto d'Este s'inspire directement des valeurs de la beauté italienne : le goût, l'élégance et le style sont à l'honneur pour vous offrir le summum de l'excellence.

Une passion innée pour tout ce qui est art et culture associée à une tradition céramique consolidée et profonde, en passant par une recherche continue, soutenue par l'innovation et la technologie, pour offrir des produits uniques dans le monde, capables de répondre à toutes les exigences de l'architecture contemporaine.

“ Créer la beauté aujourd'hui en Italie, c'est se confronter à un héritage sans égale et à un cadeau admiré dans le monde entier : une stimulation constante pour viser haut et s'améliorer. ”

EXZELLENZ IMMER UND ÜBERALL AUF DER WELT.
DAS MÖCHTEN WIR ERREICHEN

Cotto d'Este ispira la propria missione ai valori della bellezza italiana: gusto, eleganza e stile, per vivere il presente ai massimi livelli di eccellenza.

Eine angeborene Leidenschaft für alles, was mit Kunst und Kultur zu tun hat, verbindet sich mit einer konsolidierten und tiefgründigen Keramiktradition. Dank kontinuierlicher Forschung, Innovationen und Technologie werden einzigartige und weltweit vertriebene Produkte produziert, die alle Bedürfnisse der zeitgenössischen Architektur erfüllen.

“ Schönheit in Italien zu schaffen bedeutet heute, sich mit einem unvergleichlichen Erbe und einer Gegenwart auseinanderzusetzen, die in der ganzen Welt bewundert werden: ein konstanter Anreiz, um immer nach vorne zu schauen und sich ständig zu verbessern. ”

QUANDO L'ESTETICA È SINONIMO DI PERFEZIONE

La bellezza per Cotto d'Este coincide con una qualità estetica e tecnologica superiore, visibile nell'esclusività di prodotti ceramici realizzati grazie a sofisticati processi produttivi, sostenuti dall'esperienza e da una cultura artigiana che ricerca la perfezione in ogni minimo dettaglio.

Sperimentiamo costantemente nuove materie prime pregiate, metodologie e lavorazioni, alla ricerca di cromatismi originali, finiture preziose ed effetti ispirati ai materiali più belli presenti in natura, per creare superfici uniche, capaci di distinguersi.

WHEN AESTHETICS
IS SYNONYMOUS WITH PERFECTION

For Cotto d'Este beauty coincides with superior aesthetics and technological quality, visible in the exclusivity of the ceramic products made thanks to sophisticated production processes, supported by experience and an artisan culture that seeks perfection in every detail. We constantly experiment with new high quality raw materials, methodologies and processes, looking for original colours, quality finishes and effects inspired by the most beautiful materials present in nature, to create unique surfaces, which stand out.

QUAND L'ESTHÉTIQUE
EST SYNONYME DE PERFECTION

La beauté pour Cotto d'Este coincide avec une qualité esthétique et technologique supérieure, visible dans l'exclusivité de produits céramiques réalisés grâce à des processus de production sophistiqués, soutenus par l'expérience et par une culture artisanale qui recherche la perfection dans les moindres détails. Nous expérimentons constamment de nouvelles et précieuses matières premières, des méthodes et des procédés de production, à la recherche de couleurs originales, de finitions de grande valeur et d'effets inspirés aux plus beaux matériaux présents dans la nature, pour créer des surfaces uniques, capables de se distinguer.

WENN ÄSTHETIK
GLEICHBEDEUTEND IST MIT PERFEKTION

Für Cotto d'Este bedeutet Schönheit überlegene ästhetische und technologische Qualität, sichtbar in der Exklusivität der Keramikprodukte, die dank technisch innovativer Produktionsprozesse hergestellt werden und, unterstützt durch Erfahrung und eine Handwerkskultur, die Perfektion in jedem Detail sucht. Wir experimentieren ständig mit neuen hochwertigen Rohstoffen, Methoden und Verfahren, auf der Suche nach originellen Farben, edlen Oberflächen und Effekten, die sich an den schönsten Materialien der Natur inspirieren, um einzigartige Oberflächen zu kreieren, die sich von anderen abheben.



INNOVAZIONE E LEADERSHIP TECNOLOGICA FIRMANO L'UNICITÀ DELLE NOSTRE ECCELLENZE

Cotto d'Este porta avanti una sua personale ed intensa attività di Ricerca e Sviluppo finalizzata ad individuare nuove metodologie produttive che rispondano ai massimi livelli di qualità ed eccellenza.

Primi nel mondo ad introdurre sul mercato l'esclusivo gres porcellanato ad alto spessore (14 mm) e le grandi lastre sottili Kerlite, abbiamo rivoluzionato il modo di pensare e fare ceramica, offrendo soluzioni innovative con elevatissime performance tecniche, da applicare in qualsiasi contesto architettonico e senza rinunciare a quella personalissima impronta di stile ed eleganza che caratterizza tutte le nostre creazioni.

INNOVATION AND TECHNOLOGICAL
LEADERSHIP ARE THE HALLMARKS OF OUR
UNIQUE PRODUCTS

Cotto d'Este is driven forward by its staff and intense Research and Development activity aimed at identifying new production methods that meet the highest levels of quality and excellence. The first in the world to introduce on the market exclusive high thickness porcelain stoneware (14 mm) and large thin Kerlite slabs, we have revolutionized the way of thinking about and making ceramics, offering innovative solutions with very high technical performance, to be installed in any architectural context and without renouncing to that personal touch of style and elegance that characterizes all our creations.

INNOVATION ET LEADERSHIP
TECHNOLOGIQUE SIGNENT L'UNICITÉ DE
NOS PRODUITS

Cotto d'Este poursuit une activité de recherche et de développement personnelle et intense visant à identifier de nouvelles méthodes de production qui répondent aux plus hauts niveaux de qualité et d'excellence. Premiers au monde à introduire sur le marché le grès cérame d'épaisseur majorée (14 mm) et les grandes dalles fines Kerlite, nous avons révolutionné la manière de penser et de faire de la céramique en proposant des solutions innovantes à très hautes performances techniques, trouvant leur place dans n'importe quel contexte architectural, sans renoncer à cette touche très personnelle de style et d'élégance qui caractérise toutes nos créations.

INNOVATION UND TECHNOLOGISCHES
LEADERSHIP ZEICHNEN DIE
EINZIGARTIGKEIT UNSERER PRODUKTE AUS

Cotto d'Este führt eine persönliche und intensive Forschungs- und Entwicklungstätigkeit durch, die darauf abzielt, neue Produktionsmethoden zu erkennen, die den höchsten Qualitäts- und Spitzenstandards entsprechen. Als weltweit erstes Unternehmen, das Feinsteinzeug mit hoher Dicke (14 mm) und die großen dünnen Kerlite-Platten auf den Markt brachte, haben wir die Denkweise und Herstellung von Keramik revolutioniert und bieten innovative Lösungen mit sehr hohen technischen Leistungen für jeden architektonischen Kontext an, ohne auf die persönliche Note von Stil und Eleganz zu verzichten, die all unsere Kreationen auszeichnet.



UNA SCELTA CHE È PER SEMPRE, CERTIFICATA DA 20 ANNI DI GARANZIA

Da sempre siamo i primi a credere nell'unicità dei nostri prodotti, sintesi di qualità estetiche, tecniche e progettuali superiori, destinate a durare nel tempo. Non a caso oggi siamo leader nella produzione di pavimenti e rivestimenti di alta gamma, perché l'affidabilità e la perfezione estetica delle nostre superfici sono ormai un valore indiscusso, sostenuto da importanti certificazioni internazionali a cui aggiungiamo la nostra personale garanzia, applicata sulla totalità dei prodotti fino a 20 anni dall'acquisto.

A CHOICE THAT HAS ALWAYS BEEN CERTIFIED
BY A 20-YEAR WARRANTY

We have always been the first to believe in the uniqueness of our products, a synthesis of superior aesthetic, technical and design qualities, designed to endure over time. It is no coincidence that today we are leaders in the production of high-end floor and wall coverings, because the reliability and aesthetic perfection of our surfaces are now an undisputed fact, supported by important international certifications to which we add our own personal warranty, applied to the full range of products, up to 20 years from the purchase date.

UN CHOIX QUI EST POUR TOUJOURS,
CERTIFIÉ PAR UNE GARANTIE DE 20 ANS

Nous avons toujours été les premiers à croire en l'unicité de nos produits, synthèse de qualités esthétiques, techniques et de conceptions supérieures, destinées à durer dans le temps. Ce n'est pas un hasard si nous sommes aujourd'hui leaders dans la production de revêtements de sol et muraux haut de gamme, car la fiabilité et la perfection esthétique de nos surfaces sont désormais une valeur incontestable, appuyée par d'importantes certifications internationales auxquelles nous ajoutons notre garantie personnelle, qui s'applique sur la totalité des produits, jusqu'à 20 ans à compter de l'achat.

EINE ENTSCHEIDUNG FÜR IMMER, ZERTIFIZIERT
MIT EINER 20-JÄHRIGEN GARANTIE

Wir waren schon immer die Ersten, die an die Einzigartigkeit unserer Produkte glaubten: eine Synthese von überlegenen ästhetischen, technischen und kreativen Qualitäten, die für die Ewigkeit bestimmt sind. Es ist kein Zufall, dass wir heute führend in der Herstellung von hochwertigen Boden- und Wandbelägen sind, denn die Zuverlässigkeit und ästhetische Perfektion unserer Oberflächen ist nunmehr ein unbestrittener Wert, der durch wichtige internationale Zertifizierungen bestätigt wurde und dem wir unsere persönliche Garantie für alle Produkte hinzufügen, bis zu 20 Jahre nach dem Kauf.



UNA VOCAZIONE ARCHITETTONICA PROTAGONISTA DEL PROGETTO CONTEMPORANEO

Bellezza ed eccellenza tecnica sono i cardini dell'architettura contemporanea. Consapevole di questo Cotto d'Este continua a contribuire con entusiasmo e dedizione al progetto dell'abitare umano nel terzo millennio. Una solida vocazione architettonica si traduce in un dialogo aperto con architetti e progettisti affiancati dall'esperienza e dalla competenza dei nostri tecnici.

Mettiamo a disposizione servizi specifici e spazi "strategici" in cui toccare con mano la bellezza dei nostri prodotti, come la nostra sede o lo show room di Milano, per rispondere a ogni esigenza progettuale con qualità e rapidità.

AN ARCHITECTURAL VOCATION AT THE HEART OF CONTEMPORARY DESIGN

Beauty and technical excellence are the cornerstones of contemporary architecture. Aware of this Cotto d'Este continues to contribute with enthusiasm and dedication to the project of human habitation in the third millennium. A solid architectural vocation translates into an open dialogue with architects and designers supported by the experience and expertise of our technicians. We provide specific services and "strategic" spaces where it is possible to touch the beauty of our products, such as our headquarters or the Milan showroom, to meet every design requirement with quality and speed.

UNE VOCATION ARCHITECTURALE PROTAGONISTE DU PROJET CONTEMPORAIN

La beauté et l'excellence technique sont les piliers de l'architecture contemporaine. Conscient de ce Cotto d'Este continue à apporter avec enthousiasme et dévouement au projet de l'habitat humain du troisième millénaire. Une vocation architecturale solide se traduit par un dialogue ouvert avec les architectes et les concepteurs, associée à l'expérience et la compétence de nos techniciens. Nous mettons à disposition des services spécifiques ainsi que des espaces «stratégiques» où il est possible de toucher du doigt la beauté de nos produits, comme notre siège social ou le showroom de Milan, pour répondre à toutes les exigences de conception avec qualité et rapidité.

EINE ARCHITEKTONISCHE BERUFUNG, PROTAGONIST DES ZEITGENÖSSISCHEN PROJEKTS

Schönheit und technische Exzellenz sind die Eckpfeiler der zeitgenössischen Architektur. Im Bewusstsein dessen trägt Cotto d'Este mit Begeisterung und Hingabe dem Projekt Wohnen im dritten Jahrtausend bei. Eine solide architektonische Berufung führt zu einem offenen Dialog mit Architekten und Designern, der durch die Erfahrung und das Fachwissen unserer Techniker unterstützt wird. Wir bieten spezifische Dienstleistungen und „strategische“ Ausstellungsflächen an, in denen Sie die Schönheit unserer Produkte von Hand berühren können, wie in unserem Hauptsitz oder dem Showroom in Mailand. Dies erlaubt uns, jede Designanforderung mit Qualität und Schnelligkeit zu erfüllen.



FARE CERAMICA PER L'ARCHITETTURA È UN NOSTRO IMPEGNO COSTANTE

Il desiderio di sperimentare sempre nuove soluzioni per il mondo del progetto, si concretizza nella realizzazione di tante opere importanti, rese possibili attraverso collaborazioni con aziende, architetti e designer di primissimo piano, come testimoniano le nostre prestigiose referenze a livello internazionale.

L'eccellenza tecnica ed estetica di Cotto d'Este, dal cuore fortemente italiano, ha acquisito nel tempo una notorietà e un prestigio che si espandono nel mondo per stimolare idee e progetti sempre più ambiziosi.

MAKING CERAMICS FOR ARCHITECTURE IS
OUR CONSTANT COMMITMENT

The desire to always experiment with new solutions for the world of design, is established through the realization of many important works, made possible through collaborations with companies, architects and designers of the highest level, as evidenced by our prestigious international references. The technical and aesthetic excellence of Cotto d'Este, with its strong Italian spirit, has acquired a reputation and a prestige over time that has expanded all over the world to stimulate ideas and ever more ambitious projects.

FAIRE DE LA CÉRAMIQUE POUR L'ARCHITECTURE
EST NOTRE ENGAGEMENT CONSTANT

Le désir de toujours expérimenter de nouvelles solutions pour le monde de la conception, se traduit par la réalisation de nombreux ouvrages importants, rendus possibles grâce à la collaboration avec les entreprises, architectes et designers de tout premier plan, comme en témoignent nos prestigieuses références internationales. L'excellence technique et esthétique de Cotto d'Este, au cœur fortement italien, a acquis au fil du temps une notoriété et un prestige qui se répandent dans le monde entier pour stimuler des idées et des projets de plus en plus ambitieux.

KERAMIK FÜR DIE ARCHITEKTUR, DAS IST UNSER
STÄNDIGES ENGAGEMENT

Der Wunsch, immer neue Lösungen für die Projektwelt zu experimentieren, konkretisiert sich in der Realisierung zahlreicher wichtiger Arbeiten, die dank der Kooperation mit renommierten Unternehmen, Architekten und Designern möglich waren, wie es die Referenzen weltweit belegen. Die technische und ästhetische Exzellenz von Cotto d'Este, zusammen mit einem starken italienischen Herzen, hat sich im Laufe der Zeit überall in der Welt bekannt gemacht und ein Prestige erlangt, welches die beste Anregung für immer ehrgeizigere Ideen und Projekte ist.



HAMAD INTERNATIONAL AIRPORT
DOHA - QATAR

Architectural Studio
Antonio Citterio
Patricia Viel



RESIDENTIAL TOWERS
"VERTICAL FOREST"
MILAN - ITALY

Stefano Boeri, Gianandrea Barreca, Giovanni La Varra

REALE MUTUA HEADQUARTER
TORINO - ITALY

Iotti + Pavarani Architetti

INCONTRI PROGETTI E COLLABORAZIONI

Cotto d'Este si pone al centro del dialogo con il mondo del progetto. Lo show-room di Milano è luogo di incontro privilegiato con figure di spicco dell'architettura. Prestigiose installazioni hanno visto inoltre importanti progettisti cimentarsi nell'interpretazione dei nostri materiali, che sono stati anche oggetto di ispirazione per concorsi e gare creative volte a generare nuove affascinanti applicazioni.

MEETINGS, PROJECTS, AND PARTNERSHIPS

Cotto d'Este positions itself at the centre of the dialogue with the world of design. The showroom in Milan is an exclusive meeting place for prominent figures from the architectural field. Acclaimed designers have created prestigious installations using our materials, which have also been the inspiration for creative events and contests aimed at generating new and interesting applications.

RENCONTRES, PROJETS ET PARTENARIATS

Cotto d'Este réussit toujours à se placer au centre du dialogue lorsque les sujets concernent le monde de la conception. Le showroom de la marque situé à Milan est d'ailleurs un parfait lieu de rencontre où il est possible de découvrir les projets d'architectes réputés. À travers de prestigieux aménagements, des designers de grande renommée ont pu se lancer dans l'interprétation de nos matériaux, notamment à l'occasion de concours et de compétitions orientés sur l'originalité et la créativité, afin de donner naissance à de nouveaux styles et applications fascinantes.

MEETINGS, PROJEKTE UND KOOPERATIONEN

Cotto d'Este stellt sich in den Mittelpunkt des Dialogs mit der Welt des Designs. Der Showroom in Mailand ist ein privilegierter Treffpunkt mit führenden Persönlichkeiten der Architektur. Renommierete Installationen von bedeutenden Designern, die unsere Materialien interpretiert haben, wurden Gegenstand der Inspiration für Wettbewerbe und Kreativwettbewerbe zur Erstellung neuer faszinierender Anwendungen.



ALL OVER - SALONE DEL MOBILE
MILANO - ITALY
Ferruccio Laviani



TREE ANGLE
PROGETTO VINCITORE DEL CONCORSO KERLIGHT
Studio 967 arch



DOMUS INCONTRA COTTO D'ESTE In senso orario da sinistra: Michele De Lucchi, Barreca & La Varra, Camillo Botticini, Francesco Librizzi, Traverso-Vighy, TAM Associati, tra i protagonisti degli incontri realizzati con la prestigiosa rivista di architettura internazionale



IL NOSTRO GRUPPO

OUR GROUP | NOTRE GROUPE | UNSER KONZERN

PANARIAGROUP. NEL TEMPO E NEL MONDO, L'ECCELLENZA CERAMICA

THROUGHOUT TIME
AND AROUND THE WORLD,
CERAMIC EXCELLENCE

To excel in the world of high quality ceramics means knowing how to continuously create highly technological products and how to enhance them through the utmost attention to aesthetics and detail. Panariagroup has always adhered to the highest standards of excellence, combining its history of skilful artisan craftsmanship with cutting edge technology. This approach is intrinsically linked to a fundamental commitment to always act and operate responsibly.

With over 40 years of experience, Panariagroup is an international company with a strong Italian soul and an extensive sales network with 8 brands in over 130 countries all over the world.

DANS LE TEMPS
ET DANS LE MONDE,
L'EXCELLENCE CÉRAMIQUE

Exceller, dans le monde de la céramique de haute qualité, signifie toujours savoir créer des produits à composante technologique élevée et les enrichir avec la plus grande attention esthétique, en soignant tous les détails. Pour satisfaire au mieux les goûts de la plage la plus élevée et la plus exigeante du marché, Panariagroup adopte depuis toujours la formule de l'excellence, unissant la connaissance historique artisanale et l'attitude technologiquement à l'avant-garde. Avec un engagement fondamental à agir et œuvrer toujours de manière responsable. Avec plus de 40 ans d'expérience, Panariagroup est aujourd'hui un groupe international avec un cœur fortement italien, présente avec 8 marques dans plus de 130 pays dans le monde, grâce à un vaste réseau commercial à tous les niveaux.

MIT DER ZEIT
UND IN DER WELT,
DIE EXZELLENZ DER KERAMIK

Exzellenz in der Welt der hochwertigen Keramik bedeutet zu wissen, wie man kontinuierlich Produkte herstellt, die nicht nur eine hohe technologische Komponente aufweisen, sondern die mit besonderem Augenmerk auf die Ästhetik bis ins kleinste Detail realisiert werden. Panariagroup arbeitet seit jeher mit der Formel der Exzellenz, um dem Geschmack des anspruchsvollsten Marktsegments gerecht zu werden. Historische Handwerkskunst vereint sich mit technologischem Fortschritt, wobei ein verantwortungsvolles Handeln absolute Voraussetzung ist. Mit mehr als 40 Jahren Erfahrung ist die Panariagroup heute eine internationale Realität mit einem starken italienischen Herzen, die dank eines großen und weit verbreiteten Handelsnetzes weltweit mit 8 Marken in über 130 Ländern präsent ist.

Eccellere, nel mondo della ceramica di alta qualità, significa saper generare sempre prodotti a elevata componente tecnologica e impreziosirli con la massima attenzione estetica, con la cura di ogni dettaglio. Per soddisfare al meglio i gusti della fascia più elevata ed esigente del mercato, Panariagroup adotta da sempre la formula dell'eccellenza, unendo storica sapienza artigianale e attitudine all'avanguardia tecnologica. Con un impegno fondamentale ad agire e operare sempre con responsabilità. Con oltre 40 anni di esperienza, Panariagroup è oggi una realtà internazionale con un cuore fortemente italiano, presente con 8 brand in oltre 130 paesi nel mondo grazie a una vasta e capillare rete commerciale.



LEA
CERAMICHE

COTTOD'ESTE
Nuove Superfici

Blustyle
BY COTTO D'ESTE

MARGRES
CERAMIC TILES

LOVE
CERAMIC TILES

floridatile

Bellissimo
STILE ITALIANO

PANARIAgroup®
www.panariagroup.it



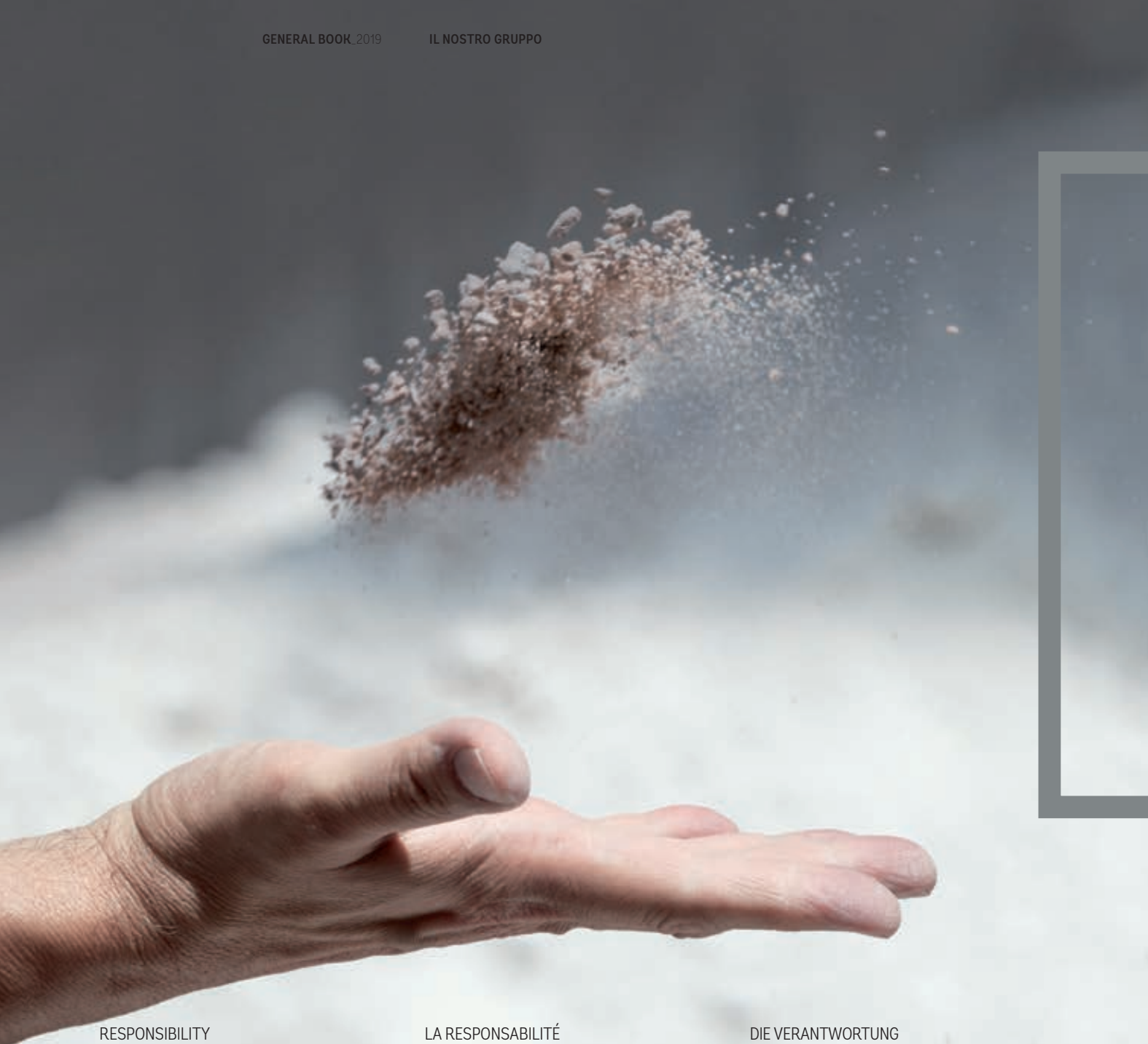

LA RESPONSABILITÀ OLTRE LA SUPERFICIE

RESPONSIBILITY BELOW THE SURFACES

Panariagroup manufactures products that are a part of the lives of millions of people all over the world, in homes and public spaces; this is the basis for the company's fundamental and essential commitment to **operating responsibly**. Always at the forefront in its knowledge of combining beauty, quality and sustainability, **Panariagroup** makes every effort to reduce the environmental impact of its products and plants. For the Group, the principle of sustainability also embraces policies and practices that involve and govern the impacts of the organisation, both economically and socially. To find out more about **Panariagroup's** commitment and specific initiatives, you can refer to the **Sustainability Report 2017**, which can be downloaded here at www.panariagroup.it or requested via email at sustainability@panariagroup.it.

LA RESPONSABILITÉ AU-DELÀ DE LA SURFACE

Panariagroup réalise des produits qui rencontrent la vie quotidienne de millions de personnes dans le monde, dans les maisons et dans les environnements publics ; c'est de là que naît l'engagement fondamental et incontournable à **agir de manière responsable**. Depuis toujours à l'avant-garde en unissant de manière habile beauté, qualité et durabilité, **Panariagroup** s'engage quotidiennement pour réduire l'impact environnemental de ses produits et de ses établissements. Pour le Groupe, le principe d'agir dans le respect de la durabilité englobe également des politiques et des pratiques qui impliquent et réglementent les impacts de l'organisation, aussi bien au niveau économique que social. Pour en savoir davantage sur l'engagement et sur les initiatives concrètes de **Panariagroup**, il est possible de consulter le **Bilan de Durabilité 2017**, téléchargeable sur le site www.panariagroup.it ou peut être demandé par courriel à sustainability@panariagroup.it.

DIE VERANTWORTUNG GEHT ÜBER DIE OBERFLÄCHE HINAUS

Panariagroup stellt Produkte her, die im täglichen Leben von Millionen von Menschen weltweit zu Hause und in öffentlichen Umgebungen zu finden sind. Und hier entsteht die grundlegende und unvermeidliche Verpflichtung, **mit Verantwortung zu handeln**. **Panariagroup** ist stets ganz vorne, wenn es darum geht, Schönheit, Qualität und Nachhaltigkeit sinnvoll miteinander zu verbinden. Das Unternehmen bemüht sich täglich, die Umweltauswirkungen seiner Produkte und Anlagen zu reduzieren. Außer dem Prinzip der Nachhaltigkeit wirkt sich auch die Unternehmenspolitik des Konzerns auf die Organisation sowohl in wirtschaftlicher Hinsicht als auch auf sozialer Ebene aus. Um mehr über das Engagement und die konkreten Initiativen der **Panariagroup** zu erfahren, können Sie den **Nachhaltigkeitsbericht 2017** konsultieren, den Sie hier herunterladen www.panariagroup.it oder per E-Mail an sustainability@panariagroup.it anfordern können.

Panariagroup realizza prodotti che incontrano la vita quotidiana di milioni di persone nel mondo, nelle case e negli ambienti pubblici; nasce da qui l'impegno fondamentale e imprescindibile a **operare con responsabilità**. Da sempre all'avanguardia nel coniugare in modo sapiente bellezza, qualità e sostenibilità, **Panariagroup** si impegna quotidianamente per ridurre l'impatto ambientale dei suoi prodotti e stabilimenti. Per il Gruppo, inoltre, il principio dell'agire nel rispetto della sostenibilità abbraccia anche politiche e pratiche che coinvolgono e regolano gli impatti dell'organizzazione, a livello sia economico sia sociale. Per conoscere di più sull'impegno e sulle iniziative concrete di **Panariagroup**, è possibile consultare il **Bilancio di Sostenibilità 2017**, scaricabile dal sito www.panariagroup.it o richiedibile via mail a sustainability@panariagroup.it.

VARIETÀ DI SPESSORI E TECNOLOGIE PER PROGETTI DISTINTIVI. UNA GAMMA COMPLETA E VERSATILE.

Cotto d'Este offre una gamma completa di prodotti in gres porcellanato con formati e spessori diversi per rispondere a tutte le necessità della moderna architettura. Le lastre sottili Kerlite in grande formato regalano continuità visiva agli spazi e consentono di sperimentare nuove applicazioni nel mondo dell'interior design. Il gres porcellanato spessorato di 14 mm amplifica la bellezza e la resistenza delle superfici sia in interno che in esterno, l'extra spessore dei prodotti in 20 mm consente soluzioni facili e versatili per le pavimentazioni esterne di zone residenziali e aree pubbliche.

20mm

14mm

5plus (5,5 mm)

6plus (6,5 mm)

Rinforzato con stuoia in fibra di vetro
Reinforced with fibreglass
Renforcé avec de la fibre de verre
Mit Glasfaserverstärkung

3plus (3,5 mm)

Rinforzato con stuoia in fibra di vetro
Reinforced with fibreglass
Renforcé avec de la fibre de verre
Mit Glasfaserverstärkung

A WIDE ASSORTMENT OF THICKNESSES
AND TECHNOLOGIES FOR DISTINCTIVE
PROJECTS A COMPLETE AND VERSATILE
RANGE

Cotto d'Este offers a complete range of porcelain stoneware products with different sizes and thicknesses to meet all the needs of modern architecture. The large size Kerlite thin slabs give visual continuity to spaces and make it possible to experiment with new applications in the world of interior design. The 14 mm thick porcelain stoneware amplifies the beauty and the resistance of the surfaces both indoors and outdoors, the extra thickness of the products in 20 mm allows easy and versatile solutions for outdoor flooring in residential areas and public spaces.

PROJECTS | VARIÉTÉS D'ÉPAISSEURS
ET DE TECHNOLOGIES POUR PROJETS
DISTINCTIFS UNE GAMME COMPLÈTE ET
VERSATILE

Cotto d'Este propose une gamme complète de produits en grès cérame de différents formats et épaisseurs pour répondre à tous les besoins de l'architecture moderne. Les dalles fines grand format Kerlite donnent une continuité visuelle aux espaces et vous permettent d'expérimenter de nouvelles applications dans le monde du design d'intérieur. Le grès cérame d'épaisseur majorée de 14 mm amplifie la beauté et la résistance des surfaces tant à l'intérieur qu'à l'extérieur, la sur-épaisseur des produits en 20 mm permet des solutions simples et polyvalentes pour les sols extérieurs dans les zones résidentielles et les espaces publics.

VIELFALT VON DICKEN UND
TECHNOLOGIEN FÜR BESONDERE
PROJEKTE A COMPLETE AND VERSATILE
RANGE

Cotto d'Este bietet ein komplettes Angebot von Feinsteinzeugprodukten in verschiedenen Größen und Stärken, um allen Anforderungen moderner Architektur gerecht zu werden. Die dünnen Kerlite-Platten im Großformat verleihen den Räumlichkeiten visuelle Kontinuität und ermöglichen es, neue Anwendungen in der Welt der Innenarchitektur zu experimentieren. Das 14 mm starke Feinsteinzeug unterstreicht die Schönheit und Widerstandsfähigkeit der Oberflächen sowohl im Innen- als auch im Außenbereich. Die Extradicke der Produkte von 20 mm ermöglicht einfache und vielseitige Lösungen für Außenböden in Wohngebieten und öffentlichen Bereichen.

kerlite

LASTRE CERAMICHE SOTTILI DI QUALITÀ SUPERIORE

Gres porcellanato laminato, rinforzato con fibra di vetro:

un materiale leggero, versatile e resistente per nuove prospettive progettuali nel mondo dell'architettura e dell'abitare.

Massimi standard qualitativi e prestazionali

Grazie all'utilizzo di materie prime pregiate

Lastre supercompatte ed elastiche

Grazie a un processo di pressatura unico

Eccellente resa estetica dei materiali

Grazie a tecniche esclusive di lavorazione delle superfici

Straordinaria extra-resistenza

Grazie al rinforzo in fibra di vetro

Alta sostenibilità ambientale

Meno materie prime utilizzate, minor consumo di acqua ed energia, minori emissioni di CO₂

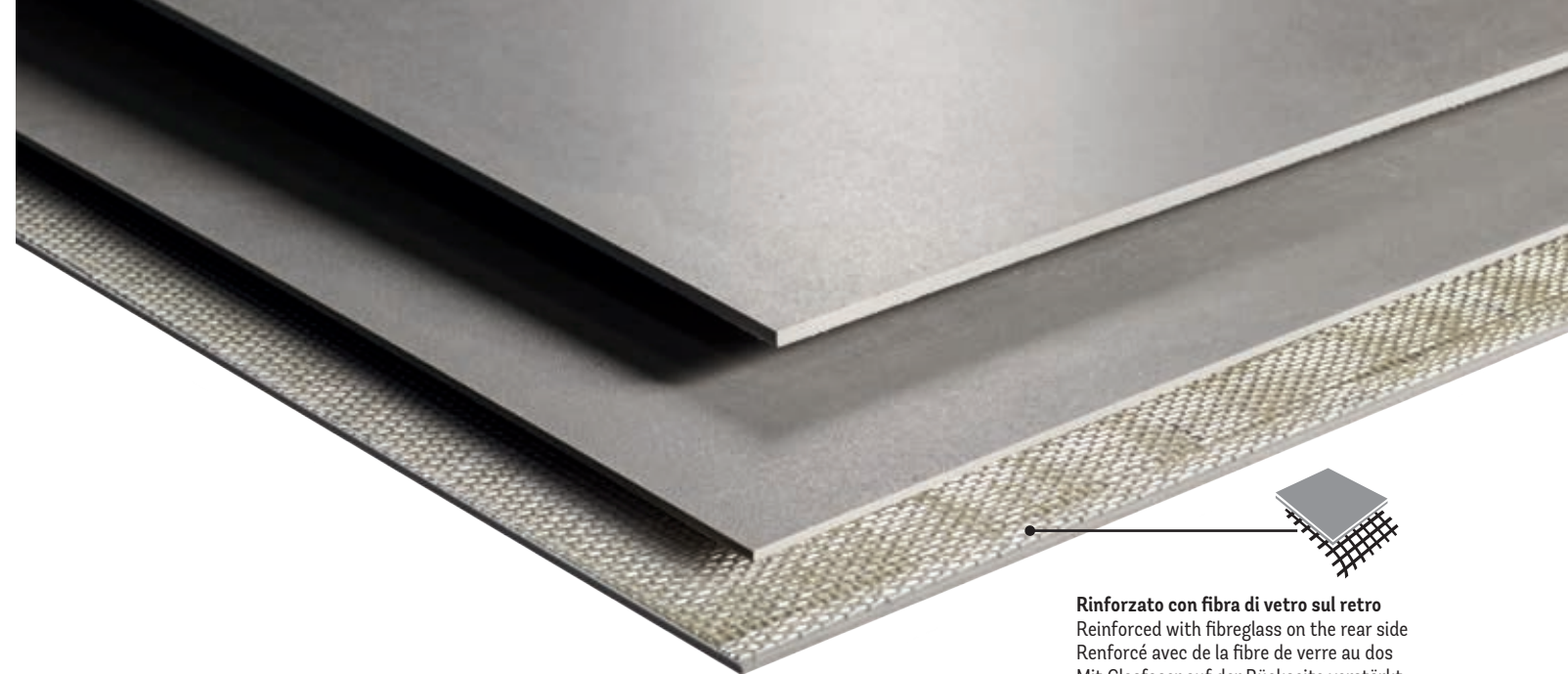

Rinforzato con fibra di vetro sul retro
Reinforced with fibreglass on the rear side
Renforcé avec de la fibre de verre au dos
Mit Glasfaser auf der Rückseite verstärkt

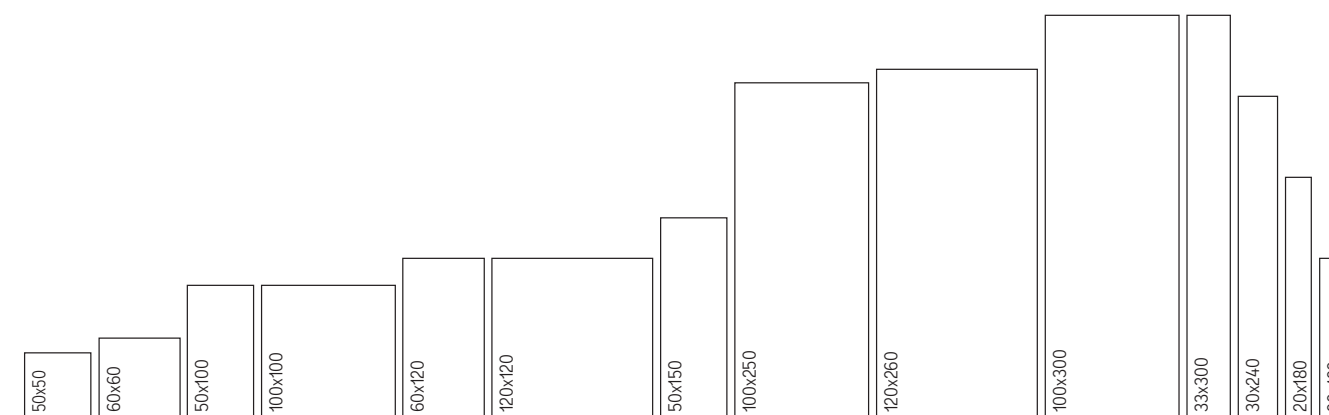

SUPERIOR QUALITY THIN CERAMIC SLABS

Large-sized laminated porcelain stoneware reinforced with fibreglass: a light, resistant and versatile product for new design perspectives in the world of architecture and housing.

Highest standards in quality and performance

Thanks to the use of the best raw materials

Highly compact and elastic slabs

Thanks to a unique pressing process

Excellent aesthetic look of the products

Thanks to exclusive surface processing technologies

Extraordinary added resistance

Thanks to the reinforcing fibreglass mesh

Highly eco-friendly

Less raw materials used, lower water and energy consumption and lower CO₂ emissions

GRÈS CÉRAME FIN DE QUALITÉ SUPÉRIEURE

Grès cérame laminé en grand format, renforcé de fibre de verre: un matériau léger, polyvalent et résistant pour de nouvelles perspectives conceptuelles dans le monde de l'architecture et de l'habitat.

Standards qualitatifs et performances maximales

Grâce à l'utilisation de matières premières de haute qualité

Dalles ultra compactes et élastiques

Grâce à un procédé de pressage unique

Excellent rendement esthétique des matériaux

Grâce à des techniques exclusives de traitement des surfaces

Extraordinaire extrarésistance

Grâce au renfort en fibre de verre

Durabilité environnementale élevée

Moins de matières premières utilisées, moins de consommation d'eau et d'énergie et moins d'émissions de CO₂

LAMINIERTES FEINSTEINZEUG MIT GLASFASERVERSTÄRKUNG

Laminiertes Feinsteinzeug im Großformat mit Glasfaserverstärkung: ein leichtes, vielseitiges und widerstandsfähiges Material für neue Designperspektiven in der Architektur und des Wohnens.

Höchste Qualitäts- und Leistungsstandards

Dank des Einsatzes hochwertiger Rohmaterialien

Superkompakte und elastische Platten

Dank eines einzigartigen Pressverfahrens

Ausgezeichnete Ästhetik der Materialien

Dank exklusiver Oberflächenbehandlungstechniken

Außergewöhnliche Widerstandsfähigkeit

Dank der Verstärkung mit Glasfasernetz

Hohe Umweltfreundlichkeit

Weniger Energieverbrauch und geringere Abgaben von CO₂

Ideale per pavimenti e rivestimenti, sia per nuove costruzioni che per ristrutturazioni con posa in sovrapposizione a pavimenti preesistenti:

kerlite 3plus

3,5mm

Ideale in ambito residenziale e commerciale leggero.

Ideal in residential and light commercial spaces.

kerlite 5plus

5,5mm

Ideale in ambito residenziale e commerciale soggetto anche a traffico intenso.

Ideal in residential and commercial spaces including those subjected to heavy traffic.

kerlite 6plus

6,5mm

Idéal pour les espaces résidentiels et commerciaux soumis à un trafic peu intense.

Idéal pour les sols et les revêtements, aussi bien pour les nouvelles constructions que pour les rénovations, il peut être posé directement sur l'ancien sol :

Idéal pour les espaces résidentiels et commerciaux soumis à un trafic peu intense.

Idéal pour les espaces résidentiels et commerciaux soumis à un trafic intense.

Ideal für Fußböden und Verkleidungen, sowohl in Neubauten als auch für Renovierungen mit Verlegung auf vorhandenen Böden:

Ideal im Wohnbereich und für leichte gewerbliche Nutzung.

Ideal im Wohnbereich und für gewerbliche Nutzung auch bei hohem Abnutzungsgrad.

14mmEXTRA THICK
PORCELAIN
STONEWARE

GRES PORCELLANATO SPESSORATO: SUPERFICI PIÙ BELLE E 3 VOLTE PIÙ RESISTENTI

Più bello

Stile elegante, design esclusivo e di prestigio
Materie prime purissime e colori più belli
Superfici dal riflesso unico e dal tocco morbido
Grandi formati
Straordinaria planarità
Fuga minima

Più resistente

3 Volte più resistente al carico di rottura
rispetto alla media dei prodotti tradizionali
Garantito fino a 20 anni
Resiste alle macchie più ostinate e non assorbe
Resiste allo sporco
Facile da pulire
Antibatterico 24 ore su 24

Ecosostenibile

Il materiale da rivestimento più durevole al mondo
Fonti energetiche rinnovabili
Minori consumi di energia e minori emissioni di CO₂
Salvaguardia delle risorse idriche
Contenuto di materiale riciclato

14mmEXTRA THICK PORCELAIN STONEWARE:
MORE BEAUTIFUL SURFACES AND 3 TIMES
MORE RESISTANT**More beautiful**

Elegant style, exclusive and prestigious design
The purest raw materials and most beautiful
colours
Surfaces with a unique brightness and a soft
texture
Large sizes
Extraordinarily flat
Minimal joint width

More resistant

3 Times more resistant to breaking load
Guaranteed up to 20 years
Resistant to the toughest stains, does not absorb
Resistant to dirt
Easy to clean
24 Hours a day antibacterial protection

Environmentally friendly

The most durable cladding material in the world
Renewable energy sources
Reduced energy consumption and reduced CO₂
emissions
Protecting water resources
Recycled material content

GRÈS CÉRAME MAJORÉ :
SURFACES PLUS BELLES ET 3 FOIS PLUS
RÉSISTANTES**Plus beau**

Style élégant, design exclusif et de prestige
Des matières premières ultra pures et des
couleurs encore plus chatoyantes
Des surfaces émanant des reflets uniques et
résultant douces au toucher
Grands formats
Planéité extraordinaire
Jointoiement minime

Plus résistant

Charge de rupture 3 fois supérieure par rapport
aux carreaux traditionnels
Garanti 20 ans
Résistant aux tâches les plus tenaces et non
absorbant
Résistant à la salissure
Facile à entretenir
Antibactérien 24 heures sur 24

Respectueux de l'environnement

Le matériau de revêtement le plus durable au
monde
Produit grâce à des énergies renouvelables
Faible consommation d'énergie et faibles
émissions de CO₂
Conservation des ressources hydriques
Fabriqué à partir de matériaux recyclés
Protecting water resources
Recycled material content

VERSTÄRKTES FEINSTEINZEUG:
SCHÖNERE OBERFLÄCHEN UND 3-MAL
WIDERSTANDSFÄHIGER**Noch schöner**

Eleganter Stil, exklusives und hochwertiges Design
Reinste Rohstoffe und schönste Farben
Oberflächen mit einzigartiger Spiegelung und
weichem Touch
Großformate
Außergewöhnliche Ebenheit
Minimale Fuge

Widerstandsfähiger

3 mal widerstandsfähiger gegen Bruchlast als
der Durchschnitt herkömmlicher Produkte.
Bis zu 20 Jahre Garantie
Widersteht den hartnäckigsten Flecken und
nimmt keine Feuchtigkeit auf.
Schmutzabweisend
Pflegerleicht
Antibakteriell 24 Stunden am Tag

Umweltverträglich

Das langlebigste Verkleidungsmaterial der Welt
Erneuerbare Energiequellen
Geringerer Energieverbrauch und CO₂-Abgaben.
Schutz der Wasserressourcen
Inhalt aus Recyclingmaterial

20mmULTRA THICK
PORCELAIN
STONEWARE

UN GRES PORCELLANATO RESISTENTE E FUNZIONALE

Una ceramica progettata per l'outdoor. Per la facilità di installazione a secco (su erba, sabbia o ghiaia; su supporti regolabili o autolivellanti) Cotto d'Este 20 mm è la soluzione più versatile per le pavimentazioni esterne di zone residenziali e aree pubbliche: vialetti di accesso, terrazze, bordi piscina, parcheggi, stabilimenti balneari, verde pubblico e altre aree urbane. Un perfetto coordinamento tra interno ed esterno.

I vantaggi dello spessore 20 mm

Altissima resistenza ai carichi di rottura
Elevata resistenza meccanica
Elevata resistenza allo scivolamento
Resistente al gelo
Resistente al fuoco
Resistente agli sbalzi termici, agli agenti atmosferici, agli acidi, alle muffe e al sale
Eccezionale resistenza alle macchie
Carrabile quando incollato su massetto
Facile da installare, rimuovere e riutilizzare
Facile da pulire
Eterno: materia e colori stabili nel tempo
Ecologico: creato nel rispetto e per la salvaguardia dell'ambiente

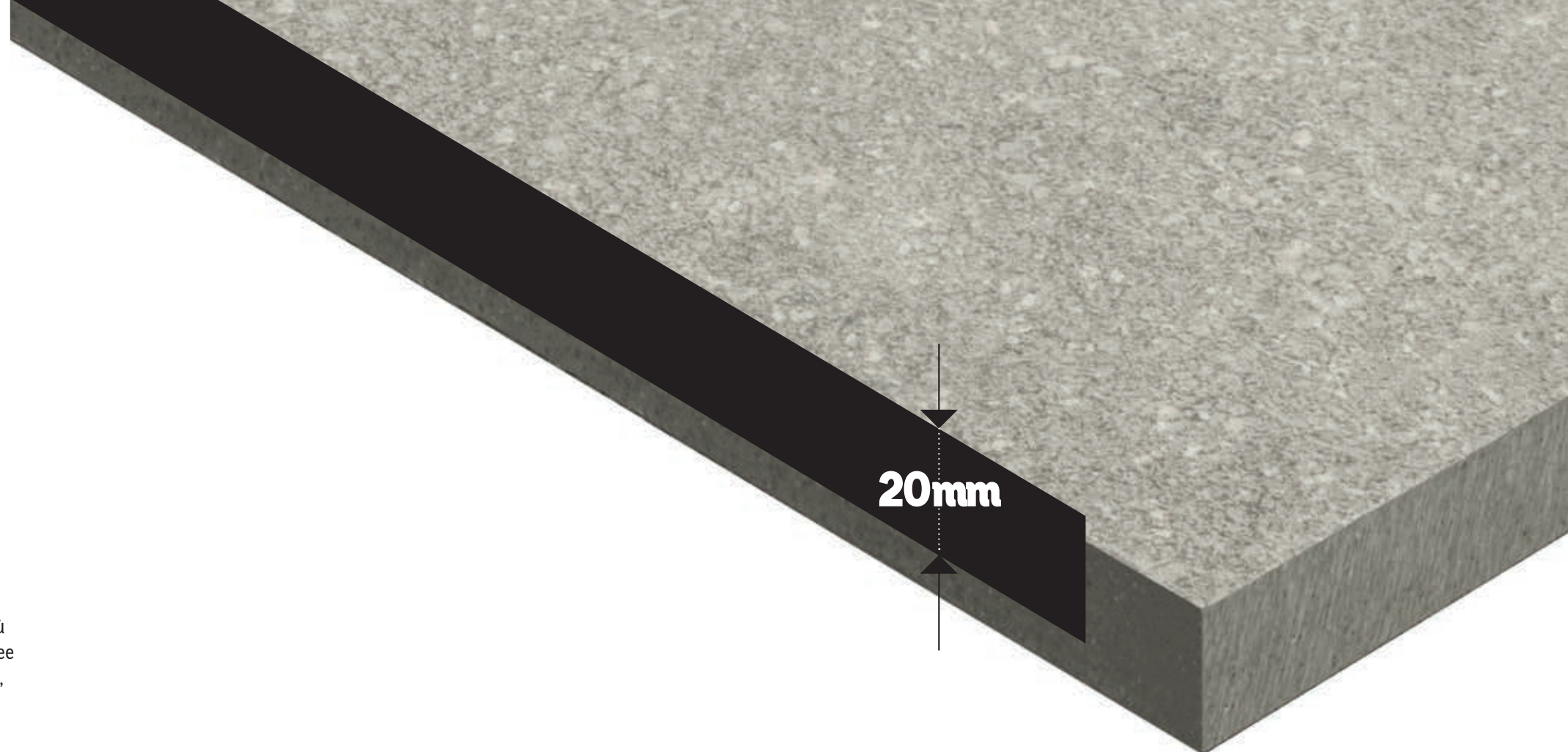

RESISTANT AND FUNCTIONAL PORCELAIN STONEWARE

Ceramics designed for outdoors. Cotto d'Este 20 mm can easily be used for dry installation (on grass, sand or gravel and on adjustable or self-levelling supports) which makes it a highly versatile solution for outdoor floors in residential and public areas, such as access paths, terraces, pool sides, parking areas, bathing facilities, parks and other urban areas. A perfect match between interior and exterior.

The advantages of a 20 mm thickness

Highly resistant to heavy loads
Superior mechanical strength
High slip resistance
Frost-resistant
Fire resistant
Resistant to thermal shock, atmospheric agents, acids, mould and salt
Exceptional resistance to stains
Resistant to vehicular passage when applied to a screed with adhesives
Easy to install, remove and reuse
Easy to clean
Eternal: the product and its colours are stable over time
Eco-friendly: manufactured in a way which respects and sustains the environment

UN GRES CERAME RESISTANT ET FONCTIONNEL

Une ceramique conçue pour la pose en extérieur Grâce à sa facilité d'installation à sec (sur herbe, sable ou gravier/sur supports réglables ou auto-nivelants), Cotto d'Este 20 mm est la solution la plus polyvalente pour les sols extérieurs des zones résidentielles et des zones publiques: allées d'accès, terrasses, bordures piscine, parkings, établissements balnéaires, espaces verts publics et autres zones urbaines. Une coordination parfaite entre intérieur et extérieur.

Les avantages d'un produit de 20 mm d'épaisseur

Haute résistance aux charges de rupture
Haute résistance mécanique
Haute résistance au glissement
Résistant au gel
Résistant au feu
Résistant aux changements de température, aux agents atmosphériques, aux acides, aux moisissures et au sel
Excellente résistance aux taches
Carrassable si collé sur la chape
Facile à installer, à retirer et à réutiliser
Facile à entretenir
Éternel: matériau et couleurs inaltérés dans le temps
Écologique: créé de manière respectueuse de l'environnement pour en assurer sa protection

EIN WIDERSTANDSFÄHIGES UND FUNKTIONELLES FEINSTEINZEUG

Eine outdoor-keramik. Wegen der einfachen Installationsmöglichkeit auf trockenem Untergrund (Rasen, Sand oder Kies; auf regulierbaren oder selbstglättenden Auflagen) ist Cotto d'Este 20 mm eine Allroundlösung für die Fußbodengestaltung von Wohnbereichen und öffentlichen Räumen im Freien: Zugangswege, Terrassen, Schwimmbadeinfassungen, Parkplätze, Strandbäder, öffentliche Grünanlagen und andere öffentliche Flächen. Ein perfektes Zusammenspiel von Innen- und Außenbereich.

Vorteile der 20 mm Stärke

Sehr hohe Bruchlastbeständigkeit
Erhöhter mechanischer Widerstand
Erhöhte Rutschfestigkeit
Frostbeständigkeit
Feuerfest
Beständig gegen Temperaturschwankungen, Witterungseinflüsse, Säuren, Schimmel und Salz
Außergewöhnliche Fleckenbeständigkeit
Befahrbar, wenn auf Estrich geklebt
Einfach zu installieren, zu entfernen und wiederzuverwenden
Pflegerleicht
Ewig: Material und Farben sind über die Zeit stabil.
Ökologisch: mit Respekt und für den Schutz der Umwelt geschaffen.

NELLA VARIETÀ DELLE NOSTRE SUPERFICI RESIÈDE L'UNICITÀ DI UNA SCELTA

Finiture straordinarie per qualità e bellezza

Cotto d'Este produce superfici in gres porcellanato di qualità superiore che ripropongono l'estetica di prodotti ispirati alla tradizione o alle più belle pietre presenti in natura, ottenuti attraverso l'utilizzo delle più evolute tecnologie produttive. Le finiture e i trattamenti delle superfici rappresentano qualcosa di unico per la ricercatezza dei dettagli e l'ampiezza di soluzioni, sempre originali e distintive.

THE UNIQUE NATURE OF THE PRODUCT
RESIDES IN THE VARIETY OF OUR SURFACES

DANS LA VARIÉTÉ DE NOS SURFACES, RÉSIDE
L'UNICITÉ D'UN CHOIX

IN DER VIELZahl UNSERER OBERFLÄCHEN
FINDET SICH DIE EINZIGARTIGKEIT EINER WAHL

Extraordinary finishes for quality and beauty

Cotto d'Este produces top quality porcelain stoneware surfaces that reproduce the aesthetics of products inspired by tradition or the most beautiful natural stones, obtained through the use of the most advanced production technologies. The finishes and the surface treatments represent something unique in terms of the refinement of the details and the amplitude of solutions, always original and distinctive.

Finitions extraordinaires pour la qualité et la beauté.

Cotto d'Este produit des surfaces en grès cérame de première qualité en reproduisant l'esthétique de produits qui s'inspirent de la tradition ou des plus belles pierres naturelles, obtenues grâce à l'utilisation des technologies de production les plus avancées. Les finitions et les traitements de surface représentent quelque chose d'unique pour le raffinement des détails et l'ampleur des solutions, toujours originales et distinctives.

Aussergewöhnliche Oberflächen für Qualität und Schönheit.

Cotto d'Este produziert hochwertige Feinsteinzeugoberflächen mit einer Ästhetik, die sich sowohl an der Tradition als auch an der Reproduktion der schönsten Natursteine inspiriert und dank des Einsatzes modernster Produktionstechnologien realisiert werden. Die Oberflächen und Oberflächenbehandlungen sind einzigartig dank der feinen Details und der zahlreichen immer originellen und unverwechselbaren Lösungen.



PER UN ABITARE SANO, SICURO E PROTETTO

L'esclusiva tecnologia Panariagroup per pavimenti e rivestimenti antibatterici ad altissime performance.



Azione potente: elimina i batteri e ne impedisce la proliferazione



Protezione continua: sempre attivo, 24 ore su 24, con e senza luce solare



Efficacia eterna: grazie alla tecnologia integrata in modo permanente nel prodotto



Qualità garantita: dalla partnership con **MICROBAN**

protect.panariagroup.it

TO LIVE HEALTHY, SAFE AND SECURE

The exclusive Panariagroup technology for anti-microbial floor and wall coverings with the highest performance.

Powerful action: eliminates microbes and prevents their reproduction

Continuous protection: always active, 24 hours a day, with and without sunlight

Eternal effectiveness: thanks to the technology permanently integrated into the product

Guaranteed quality: by the partnership with **MICROBAN**

POUR UN HABITAT SAIN, SÛR ET PROTÉGÉ

La technologie exclusive de Panariagroup pour les revêtements de sols et de murs antibactériens à hautes performances.

Action puissante: élimine les bactéries et empêche leur prolifération

Protection continue: toujours actif, 24 heures sur 24, avec et sans lumière du soleil

Efficacité éternelle: grâce à la technologie intégrée de façon permanente dans le produit

Qualité garantie: du partenariat avec **MICROBAN**

FÜR EIN GESUNDES, SICHERES UND GESCHÜTZTES WOHNEN

Die exklusive Technologie Panariagroup für antibakterielle und hochleistungsfähige Fußböden und Verkleidungen.

Leistungsstarke Wirkung: eliminiert Bakterien und verhindert die Vermehrung

Dauerschutz: rund um die Uhr aktiv, mit oder ohne Sonnenlicht

Dauerhafte Wirksamkeit: dank der permanent im Produkt integrierten Technologie

Garantierte Qualität: dank der Partnership mit **MICROBAN**



P R () T E C T



MARMI E PIETRE

MARBLE AND STONES | MARBRES ET PIERRES | MARMOR UND STEINE

BLUESTONE EVOLUTION

ADVANCED TECHNOLOGY IN BLUE

ROCKSTONE RETT. | 20 mm | 75x75 cm 30°x30°

BLUESTONE EVOLUTION

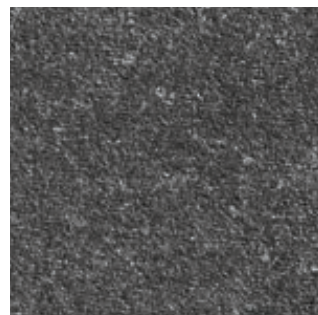

ROCKSTONE



20mm

LAYÈ

RETTIFICATO
RECTIFIED

PEZZI SPECIALI
SPECIAL PIECES



60x60 cm
24"x24"
LAYÈ



90x90 cm
36"x36"
LAYÈ



60x15 cm
24"x6"
LAYÈ
Elemento Griglia
Grill Component

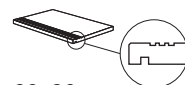

60x30 cm
24"x13³/₈"
LAYÈ
Gradone costa retta rigato
con gocciolatoio
Step tread straight edge with
grooves and drip flap



RESISTENZA ALLO
SCIVOLAMENTO
SLIP RESISTANCE

R11



STONALIZZAZIONE
DESHADING

V2



RESISTENZA ALL'ABRASIONE
PROFONDA
DEEP ABRASION RESISTANCE

143 mm³
VALORE MEDIO - AVERAGE VALUE



VISIBILITÀ DELLE IMPRONTE
TREAD MARK VISIBILITY

B



FACILITÀ DI PULIZIA
CLEANING EASINESS

2



GARANZIA 20 ANNI
20 YEARS GUARANTEE

RESIDENZIALE E PUBBLICO
RESIDENTIAL AND PUBLIC

Questa struttura superficiale solcata da profonde incisioni simili a graffi, nelle versioni 14 e 20mm è ideale per le pavimentazioni esterne dove la resistenza allo scivolamento è un requisito fondamentale.

This surface structure, carved with deep scratch-like etchings, in the 14mm and 20mm versions is ideal for exterior flooring where slip resistance is of fundamental importance.

Cette structure superficielle creusée par de profondes incisions semblables à des griffures, dans les versions 14 et 20 mm, est idéale pour les sols extérieurs où la résistance au glissement est une exigence fondamentale.

Diese von tiefen, kratzerähnlichen Kerben zerfurchte Oberflächenstruktur eignet sich in den Versionen 14 und 20mm hervorragend für Außenbodenbeläge, bei denen Rutschfestigkeit ein grundlegendes Erfordernis ist.



BUXY
NATURAL SPIRIT

PERLE NAT | ± 3.5 mm | 100x100 cm 39"x39"

BUXY

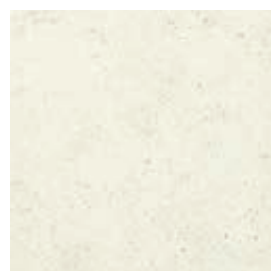

CORAIL BLANC

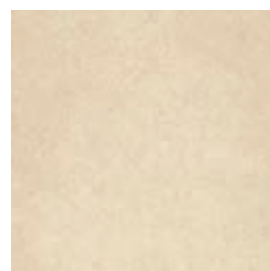

AMANDE

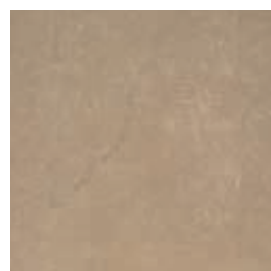

CARAMEL

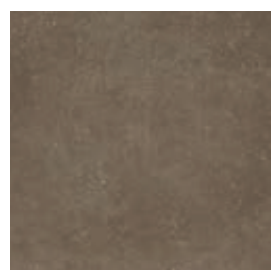

NOISETTE

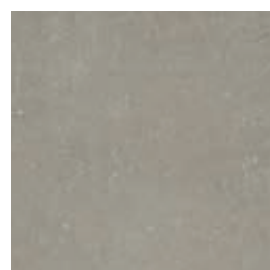

PERLE

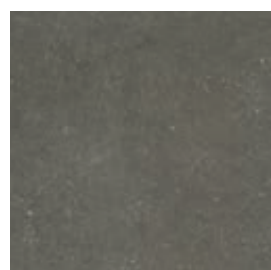

CENDRE

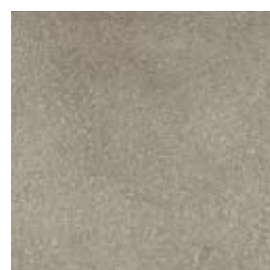

CENDRE FLAMMÉ

14mm

NATURALE LUX FLAMMÉ

RETTIFICATO
RECTIFIED

PEZZI SPECIALI
SPECIAL PIECES



60x60 cm*
24"x24"

NAT
LUX
FLAMMÉ

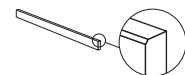

60x7,2 cm*
24"x27/8"

NAT
LUX
Battiscopa con bisello
Skirting

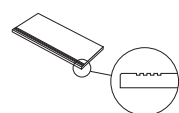

60x34 cm*
24"x13 3/8"

NAT
LUX
Gradino inciso con righe
Step tread with grooves

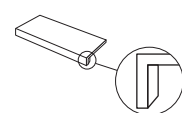

60x34 cm*
24"x13 3/8"

NAT
LUX
Gradone Plus bordo
Step tread Plus

* DISPONIBILI IN - AVAILABLE IN: AMANDE, CENDRE, PERLE, CENDRE FLAMMÉ

kerlite
3plus



3,5 mm

RETTIFICATO
RECTIFIED



100x300 cm
39"x118"

** ECCETTO: CENDRE FLAMMÉ



100x100 cm
39"x39"



50x100 cm
19 1/2"x39"



50x50 cm
19 1/2"x19 1/2"



PERLE LUX RETT. | ≙ 14 mm | 60x60 cm 24"x24"



RESISTENZA ALLO
SCIVOLAMENTO
SLIP RESISTANCE

R9 14mm NAT
R10 KERLITE 3PLUS
R12 14mm FLAMMÉ



STONIZZAZIONE
DESHADING

V2 NAT, KERLITE 3PLUS
V3 FLAMMÉ



RESISTENZA ALL'ABRASIONE
PROFONDA
DEEP ABRASION RESISTANCE

143 mm³ 14mm
175 mm³ KERLITE
VALORE MEDIO - AVERAGE VALUE



VISIBILITÀ DELLE IMPRONTE
TREAD MARK VISIBILITY

A 14mm LUX
KERLITE CARAMEL, PERLE, NOISETTE, CENDRE
B 14mm NAT, FLAMMÉ
KERLITE CORAIL BLANC, AMANDE



FACILITÀ DI PULIZIA
CLEANING EASINESS

1 14mm LUX - KERLITE
2 14mm NAT - FLAMMÉ



GARANZIA 20 ANNI
20 YEARS GUARANTEE

RESIDENZIALE E PUBBLICO
RESIDENTIAL AND PUBLIC



AMANDE LUX RETT. | 14 mm | 60x60 cm 24"x24"



Mole diamantate di grana medio-fine agiscono sulla superficie tagliando la sommità delle microscopiche creste lasciate dal tampone in resina. Si ottiene così l'inconfondibile effetto lucido-opaco dove il taglio della cresta risulta lucidato e le depressioni restano opache.

Medium to fine grain diamond discs act on the surface to smoothen the microscopic crests left by the resin punch. This is how we obtain the unique glossy-matt effect, where the cut crests are glossy and the hollows between are matt.

Des meules diamantées à granulométrie moyenne et fine agissent sur la surface en découpant le sommet des crêtes microscopiques laissées par le tampon en résine. On obtient ainsi un effet brillant-mat unique en son genre: brillant aux endroits où la crête a été découpée et mat au niveau des creux.

Diamantschleifscheiben mit mittlerer bis feiner Körnung bearbeiten die Oberfläche und schleifen die Spitze der von den Harzstempeln hinterlassenen mikroskopischen Grate ab. So wird der unverkennbare Glänzend-Matte effekt erzeugt, denn die abgeschliffenen Spitzen werden poliert und die Vertiefungen bleiben matt.



Pavimento - Floor: **NOISETTE** | \pm 3,5 mm | 50x50 cm 19 1/2" x 19 1/2" - Rivestimento - Wall: **NOISETTE** | \pm 3,5 mm | 100x300 cm 39" x 118"



Pavimento - Floor: CENDRE LUX RETT. | 14 mm | 60x120 cm 24"x48" - Rivestimento - Wall: CENDRE | 3,5 mm | 100x300 cm 39"x118"



Pavimento - Floor: CORAIL BLANC | 3,5 mm | 100x100 cm 39"x39" - Arredi - Furniture: CORAIL BLANC | 3,5 mm | 100x300 cm 39"x118"



CARAMEL NAT | 3,5 mm | 100x100 cm 39"x39"



CENDRE FLAMMÉ RETT. | 20 mm | 60x60 cm 24"x24"



FLAMMÉ

Questa superficie così unica e riconoscibile è data da uno stampo in resina ottenuto dal calco di una pietra fiammata. La fiammatura è una lavorazione possibile solo su alcune pietre dalle caratteristiche idonee (come i graniti, che contengono elevate quantità di quarzo), la cui superficie viene investita da un getto di fiamma viva a elevate temperature e subito dopo raffreddate ad acqua. Lo shock termico provoca la dilatazione della pietra e la conseguente rugosità tipica di questa finitura.

This unique and recognisable surface has been created using a resin die moulded from a stone with a flash effect. Flash effect texturing can only be performed on certain types of stone (granite, for instance, that has a high content of quartz). It consists of singeing the surface of the stone with a flame jet and then plunging the stone into water to obtain immediate cooling. The abrupt temperature change makes the stone expand and the result is a typically rough texture.

Cette surface, unique et typique, est le résultat de l'utilisation d'une matrice obtenue par le moulage d'une pierre flammée. Le flammage ne peut être réalisé que sur certaines pierres dotées de caractéristiques spécifiques (telles que les granits très riches en quartz), dont la surface est soumise à un jet de flammes vives à très hautes températures puis immédiatement refroidie à l'eau. Le choc thermique provoque la dilatation de la pierre en conférant la rugosité typique de cette finition.

Diese wirklich einzigartige und erkennbare Oberfläche wird mit einer Harzform gefertigt, die durch den Abdruck eines geflammten Steines erzeugt wird. Die Flammung ist eine Bearbeitung, die nur auf einigen Steinen mit passenden Eigenschaften möglich ist (wie die Granite, die hohe Quarzengen enthalten); ihre Oberfläche wird dabei mit einem offenen Flammenstrahl mit hohen Temperaturen behandelt und gleich danach mit Wasser abgekühlt. Der Temperaturschock verursacht die Ausdehnung des Gesteins und demzufolge die typische Rauigkeit dieser Bearbeitung.



CENDRE FLAMMÉ RETT. | 14 mm | 60x60 cm 24"x24"



CENDRE FLAMMÉ RETT. | 20 mm | 60x60 cm 24"x24"



CLUNY

ESPRIT NATUREL

BOURGOGNE NATURALE | 3,5 mm | 100x300 cm 39"x118"

CLUNY



CHAMPAGNE

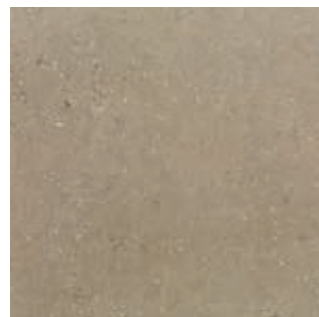

BOURGOGNE



ARGEROT



AUVERGNE



ARDENNE

14mm

ADOUCI SABLÉ LAYÉ

RETTIFICATO
RECTIFIED



90x90 cm
36"x36"
ADOUCI
SABLÉ
LAYÉ



60x60 cm
24"x24"
ADOUCI
SABLÉ

PEZZI SPECIALI
SPECIAL PIECES

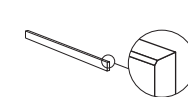

90x7,2 cm
36"x2 7/8"
ADOUCI
SABLÉ
Battiscopa con bisello
Skirting

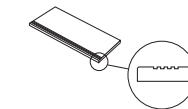

60x34 cm
24"x13 3/8"
ADOUCI
SABLÉ
Gradino inciso con righe
Step tread with grooves

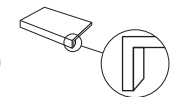

45x34 cm
18"x13 3/8"
LAYÉ
Gradone Plus bordo
Step tread Plus

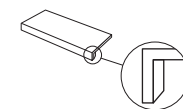

60x34 cm
24"x13 3/8"
SABLÉ
Gradone Plus bordo
Step tread Plus

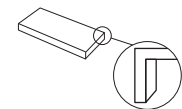

60x34 cm
24"x13 3/8"
SABLÉ
Gradone Plus angolo Destro/Sinistro
Step tread Plus Right/Left corner

DISPONIBILI IN - AVAILABLE IN: **ARGEROT, ARDENNE, BOURGOGNE, CHAMPAGNE**

kerlite
5plus

LAYÉ

5,5 mm
RETTIFICATO
RECTIFIED



100x300 cm
39"x118"
LAYÉ



100x100 cm
39"x39"
LAYÉ

kerlite
3plus

NATURALE

3,5 mm
RETTIFICATO
RECTIFIED



100x300 cm
39"x118"



100x100 cm
39"x39"

DISPONIBILI IN - AVAILABLE IN: **ARGEROT, CHAMPAGNE**

DISPONIBILI IN - AVAILABLE IN: **ARGEROT, AUVERGNE, BOURGOGNE, CHAMPAGNE**

20mm

LAYÉ

RETTIFICATO
RECTIFIED



75x75 cm
30"x30"
LAYÉ

PEZZI SPECIALI
SPECIAL PIECES



75x15 cm
30"x6"
LAYÉ
Elemento Griglia
Grill Component

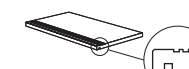

75x34 cm
30"x13 3/8"
LAYÉ
Gradone costa retta rigato
con gocciolatoio
Step tread straight edge with
grooves and drip flap

DISPONIBILI IN - AVAILABLE IN: **ARGEROT, ARDENNE, BOURGOGNE, CHAMPAGNE**



**RESISTENZA ALLO
SCIVOLAMENTO
SLIP RESISTANCE**

R11 20mm, 14mm LAYÉ
R10 14mm SABLÉ, KERLITE LAYÉ
R9 KERLITE NATURALE



**STONALIZZAZIONE
DESHADING**

V2



**RESISTENZA ALL'ABRASIONE
PROFONDA
DEEP ABRASION RESISTANCE**

143 mm² 20mm 14mm
175 mm² KERLITE
VALORE MEDIO - AVERAGE VALUE



**VISIBILITÀ DELLE IMPRONTE
TREAD MARK VISIBILITY**

A 14mm (BOURGOGNE LAYÉ)
B 14mm (SABLÉ, ADOUCI, ARDENNE LAYÉ, AGEROT
LAYÉ, CHAMPAGNE LAYÉ) 20mm, KERLITE



**FACILITÀ DI PULIZIA
CLEANING EASINESS**

1 14mm (BOURGOGNE LAYÉ)
2 14mm (SABLÉ, ADOUCI, ARDENNE LAYÉ, AGEROT
LAYÉ, CHAMPAGNE LAYÉ) 20mm, KERLITE

PROTECT
ANTIBATTERICO - ANTIMICROBIAL

14 mm ADOUCI
14 mm SABLÉ
3PLUS NATURALE



**GARANZIA 20 ANNI
20 YEARS GUARANTEE**

RESIDENZIALE E PUBBLICO
RESIDENTIAL AND PUBLIC



Una superficie strutturata, solcata da trame fitte, ideale per le pavimentazioni esterne dove la resistenza allo scivolamento è un requisito fondamentale (nei prodotti in 14 e 20 mm di spessore). Nelle lastre Kerlite 5plus la stessa struttura superficiale, leggermente attenuata, diviene un motivo decorativo in grado di creare raffinati contrasti materici grazie alle vibrazioni della luce.

A structured surface, engraved with a dense texture, perfect for external flooring where slip-resistance is a fundamental requirement (for products with a thickness of 14 and 20 mm). In the Kerlite 5plus slabs, the same superficial structure, slightly softened, becomes more decorative and capable of creating elegant textured contrasts thanks to the vibrations of light.

Une surface structurée, parcourue d'une épaisse trame, parfaite pour les sols extérieurs où la résistance à la glissance est un critère fondamental (disponible en 14 et 20 mm d'épaisseur). Au format Kerlite 5plus, cette même texture en surface apparaît de manière plus atténuée, pour former une fantaisie décorative capable de créer des contrastes raffinés de la matière qui prennent vie sous les reflets de la lumière.

Eine strukturierte Oberfläche, durchzogen von dichten Texturen, ideal für Fußbodenverlegung im Außenbereich, wo Rutschfestigkeit eine Grundvoraussetzung ist (in 14 und 20 mm Dicke erhältlich). Bei den Platten Kerlite 5plus wird die gleiche, leicht abgeschwächte oberflächliche Struktur zu einem dekorativen Motiv, das dank der Lichtschwingungen raffinierte Materialkontraste erzeugen kann.



Una superficie caratterizzata da una fine ruvidezza, priva di riflessi e dal gusto più rustico, ideale per connotare con forza ed eleganza spazi residenziali e commerciali, grazie alla sua estetica lievemente mossa che restituisce tutto il fascino della pietra naturale.

A surface characterised by a fine roughness, with no highlights and with a more rustic style, perfect for emphatically and elegantly adding character to residential and commercial spaces, thanks to its slightly rugged aesthetic that recreates the allure of natural stone.

Sa surface, légèrement rugueuse et sans reflets pour un rendu plus rustique, est idéale pour interpréter avec intensité l'élégance des espaces résidentiels et commerciaux. Ses formes légèrement sinueuses restituent toute la fascination de la pierre naturelle.

Eine Oberfläche, die sich durch eine feine, reflexlose Rauheit und rustikalen Aspekt auszeichnet. Die ideale Fliese, um Wohn- und Geschäftsräume mit Stärke und Eleganz zu kennzeichnen, die dank ihrer leicht gewellten Ästhetik und dem Reiz des Natursteins hervorgehoben wird.



Opaca e materica al tatto questa superficie presenta un leggero effetto di patinatura che la rende morbida e avvolgente. Una particolare attenzione nella scelta di materie prime pregiate genera una superficie dagli effetti cromatici delicati e con eccezionali effetti di profondità.

Opaque and with a tactile quality, this surface has a slightly burnished look that makes it soft and inviting. Particular care in the selection of high quality raw materials creates a surface with delicate coloured effects and with the extraordinary illusion of depth.

Opaque et reprenant fidèlement la matière au toucher, cette surface est légèrement patinée pour la rendre plus douce et somptueuse. Grâce aux matières premières prestigieuses employées, de délicats effets de couleurs et d'exceptionnels effets de profondeurs se distinguent en surface.

Diese Oberfläche ist matt und strukturiert und hat einen leichten Patina-Effekt, der sie weich und umhüllend macht. Die besondere Aufmerksamkeit bei der Auswahl hochwertiger Rohstoffe erzeugt eine Oberfläche mit zarten Farbeffekten und außergewöhnlicher Tiefenwirkung.



Una particolare miscela di materie fini e pregiate, lavorata attraverso un attento processo di lappatura, restituisce una superficie morbida e dal tenue riflesso opalescente, che rivela le tracce di graniglie diverse, armonicamente composte nelle forme e nei cromatismi per un effetto naturale e sofisticato.

Un mélange unique de matériaux raffinés et précieux, minutieusement soumis à une procédure de rodage, pour conférer à la surface cette sensation douce au toucher et ces délicats reflets opalescents. Les différentes grenailles employées donnent des formes et des couleurs uniques offrant cet effet naturel et sophistiqué.

A unique combination of refined and select materials, that undergo a careful lapping process, creates a soft surface with subtle opalescent highlights that reveal traces of different granules, harmoniously composed in terms of shape and colour to create a natural and sophisticated look.

Eine besondere Mischung aus feinen und hochwertigen Materialien, die durch einen sorgfältigen Läppprozess bearbeitet wurde. Das Ergebnis ist eine weiche Oberfläche mit opalisierender Reflexion, dank der Spuren verschiedener Körnungen, die harmonisch in Formen und Farben für einen natürlichen und raffinierten Effekt zusammengesetzt sind.



CHAMPAGNE SABLÉ RETT. | 14 mm | 90x90 cm 36"x36"



ARGEROT LAYÉ | 5,5 mm | 100x300 cm 39"x118"



ARGEROT LAYÉ | 5,5 mm | 100x300 cm 39"x118"





BOURGOGNE LAYÉ RETT. | ± 20 mm | 75x75 cm 30"x30"



BOURGOGNE LAYÉ RETT. | ± 20 mm | 75x75 cm 30"x30"



ARGEROT LAYÉ RETT. | 20 mm | 75x75 cm 30°x30°

ELEGANCE

SUPERIOR CLASS

Pavimento-Rivestimento - Floor-Wall: VIA TORNABUONI | ± 5.5 mm | 100x300 cm 39"x118"

ELEGANCE

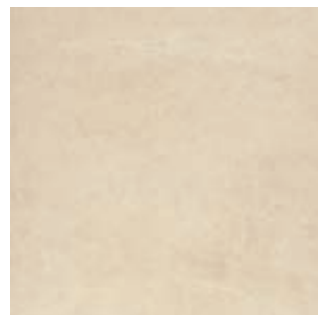

VIA CONDOTTI



VIA MONTENAPOLEONE

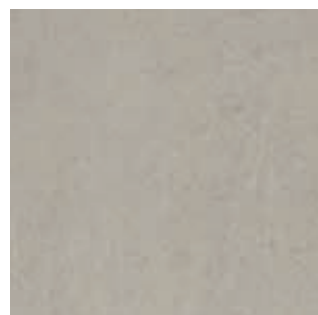

VIA TORNABUONI



VIA FARINI



Pavimento - Floor: VIA FARINI - VIA MONTENAPOLEONE | \pm 5,5 mm | 100x100 cm 39"x39"
 Rivestimento - Wall: VIA FARINI - VIA MONTENAPOLEONE | \pm 5,5 mm | 100x300 cm 39"x118"

kerlite
5plus

SILK

5,5 mm
RETTIFICATO
RECTIFIED



100x300 cm
39"x118"
SILK



100x100 cm
39"x39"
SILK



STONALIZZAZIONE
DESHADING

V2



RESISTENZA ALL'ABRASIONE
PROFONDA
DEEP ABRASION RESISTANCE

175 mm²
VALORE MEDIO - AVERAGE VALUE



VISIBILITÀ DELLE IMPRONTE
TREAD MARK VISIBILITY

B



FACILITÀ DI PULIZIA
CLEANING EASINESS

2

PROTECT
ANTIBATTERICO - ANTIMICROBIAL



GARANZIA 10 ANNI
10 YEARS GUARANTEE

RESIDENZIALE E PUBBLICO
RESIDENTIAL AND PUBLIC



VIA CONDOTTI SILK | 5.5 mm | 100x300 cm 39"x118"



VIA CONDOTTI SILK | 5.5 mm | 100x100 cm 39"x39"



EXEDRA

LUXURY STONE

CALACATTA GLOSSY | 5.5 mm | 100x300 cm 39"x118"



EXEDRA

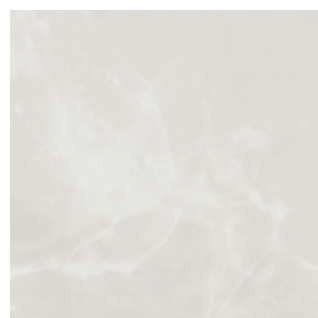

ONYX PERLE*

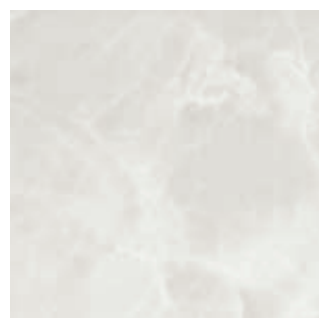

ONYX EXTRA**

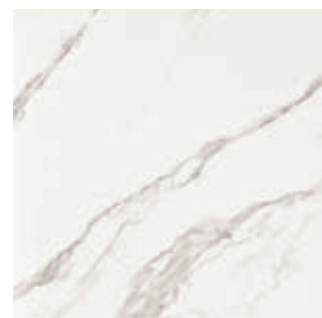

CALACATTA

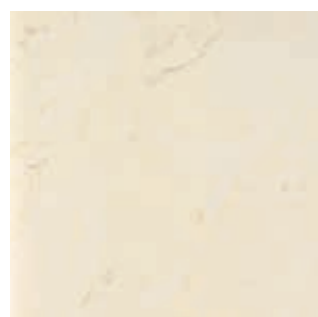

ESTREMOZ

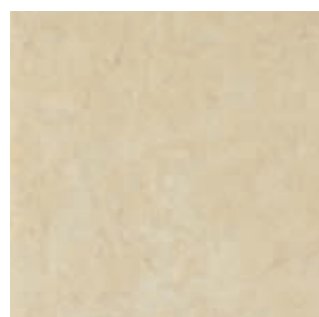

MARFIL

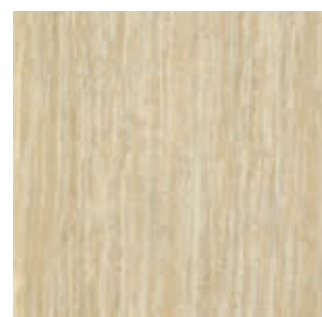

TRAVERTINO

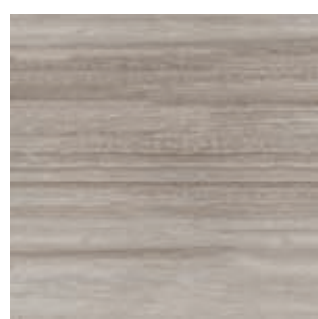

RIVERSTONE



RAIN GREY

14 mm

SILK GLOSSY

RETTIFICATO
RECTIFIED



90x90 cm
36"x36"
SILK



88x88 cm
34³/₄"x34³/₄"
GLOSSY

PEZZI SPECIALI
SPECIAL PIECES

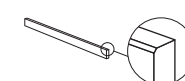

90x7,2 cm
36"x2⁷/₈"
SILK
Battiscopa con bisello
Skirting

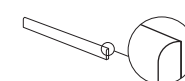

88x7,2 cm
34³/₄"x2⁷/₈"
GLOSSY
Battiscopa a becco
di civetta
Bullnose

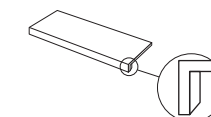

60x34 cm
24"x13³/₈"
SILK
GLOSSY
Gradone Plus bordo
Step tread Plus

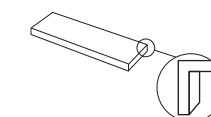

60x34 cm
24"x13³/₈"
SILK
GLOSSY
Gradone Plus angolo
Destro/Sinistro
Step tread Plus
Right/Left corner

kerlite 5plus

SILK GLOSSY

5,5 mm
RETTIFICATO
RECTIFIED

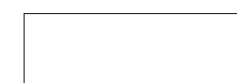

100x300 cm
39"x118"
SILK
GLOSSY



100x250 cm
39"x98¹/₂"
SILK
GLOSSY



100x100 cm
39"x39"
SILK
GLOSSY



50x100 cm
19¹/₂"x39"
SILK
GLOSSY

* DISPONIBILE SOLO - ONLY AVAILABLE: **14 mm**
** DISPONIBILE SOLO - ONLY AVAILABLE: **KERLITE**



STONALIZZAZIONE
DESHADING

V2



RESISTENZA ALL'ABRASIONE
PROFONDA
DEEP ABRASION RESISTANCE

143 mm³ 14mm
175 mm³ KERLITE
VALORE MEDIO - AVERAGE VALUE



VISIBILITÀ DELLE IMPRONTE
TREAD MARK VISIBILITY

B



FACILITÀ DI PULIZIA
CLEANING EASINESS

2

PROTECT
ANTIBATTERICO - ANTIMICROBIAL

14 mm
KERLITE



GARANZIA 20 ANNI
20 YEARS GUARANTEE

14mm SILK
RESIDENZIALE | RESIDENTIAL



GARANZIA 10 ANNI
10 YEARS GUARANTEE

KERLITE SILK
RESIDENZIALE E PUBBLICO | RESIDENTIAL AND PUBLIC
14mm SILK
PUBBLICO | PUBLIC
GLOSSY (Kerlite, 14mm)
RESIDENZIALE | RESIDENTIAL



Il tipico aspetto dei pavimenti marmorei levigati riproposto ora in ceramica nella raffinata bellezza delle superfici classiche. Questa eccezionale superficie si ottiene grazie ad una sequenza di mole diamantate a grana molto fine (5.000 μm).

The typical appearance of polished marble floors and the refined beauty of classical surfaces has now become ceramics. This exceptional surface is obtained by means of diamond grinding wheels with an exceptionally fine grain (5000 micron).

L'aspect typique des sols en marbre polis proposé aujourd'hui en céramique avec la beauté raffinée des surfaces classiques. Cette surface exceptionnelle est obtenue par le biais d'une série de meules diamantées à granulométrie très fine (5000 microns).

Das typische Aussehen von polierten Marmorfußböden wird nun als Keramik in der vornehmen Schönheit klassischer Oberflächen angeboten. Diese einzigartige Oberfläche entsteht durch eine Sequenz von sehr feinkörnigen Diamantschleifscheiben (5.000 micron).



Spazzole al carburo di silicio a grana mista (meno abrasive di quelle diamantate) agiscono sulla speciale miscela di minerali nobili applicati in superficie. Il risultato è il caratteristico effetto seta che dà il nome a questa finitura.

Silicon carbide brushes with different grain sizes (less abrasive than diamond brushes) work on the special mixture of noble minerals applied to the surface. The result is the typical silk effect that gives the name to this finish.

Des brosses au carbure de silicium à granulométrie mixte (moins abrasives que les brosses diamantées) agissent sur le mélange spécial de minéraux nobles appliqués sur la surface. Le résultat est un effet soyeux caractéristique comme l'indique le nom de cette finition.

Karborund-Schleifbürsten mit gemischter Körnung (weniger reibfähig als Diamantbürsten) wirken auf die Spezialmischung edler Mineralien an der Oberfläche. Das Ergebnis ist der charakteristische Seideneffekt, der dieser Ausführung ihren Namen verleiht.

20th
Main Hall



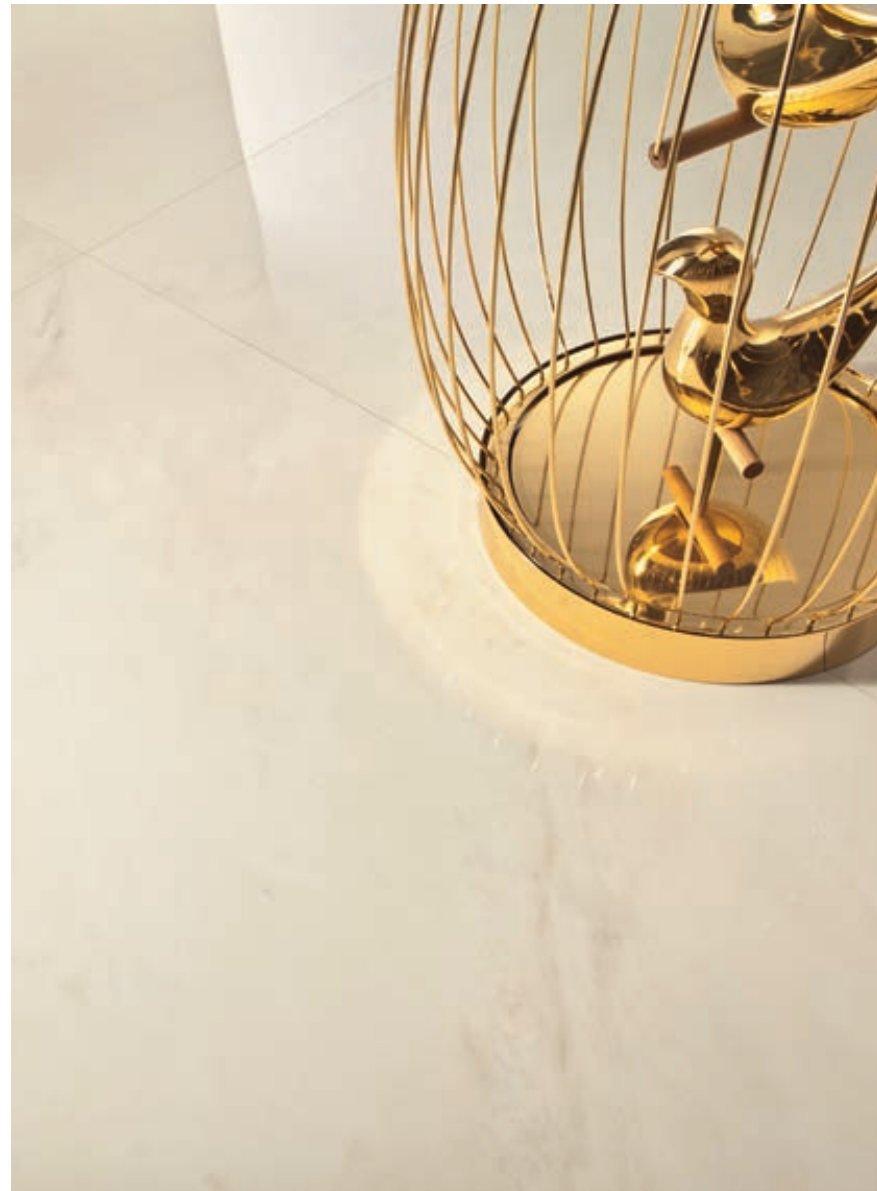

ESTREMOZ GLOSSY RETT. | 14 mm | 88x88 cm 34³/₄"x34³/₄"



ESTREMOZ SILK | 5.5 mm | 100x100 cm 39"x39"



MARFIL GLOSSY | ± 5.5 mm | 100x300 cm 39"x118"



TRAVERTINO SILK RETT. | 14 mm | 90x90 cm 36"x36"



TRAVERTINO GLOSSY RETT. | 14 mm | 88x88 cm 34 3/4"x34 3/4"



ONYX EXTRA SILK | ➤ 5,5 mm | 100x300 cm 39"x118"



Pavimento - Floor: ONYX PERLE GLOSSY RETT. | ➤ 14 mm | 90x90 cm 36"x36" - Rivestimento - Wall: ONYX EXTRA GLOSSY | ➤ 5,5 mm | 100x300 cm 39"x118"





LIMESTONE

STONE SURFACE

Pavimento - Floor: SLATE NATURAL | 5,5 mm | 100x300 cm 39"x118" - Rivestimento - Wall: CLAY NATURAL | 5,5 mm | 100x300 cm 39"x118"

LIMESTONE

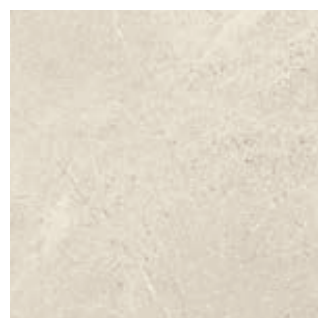

CLAY

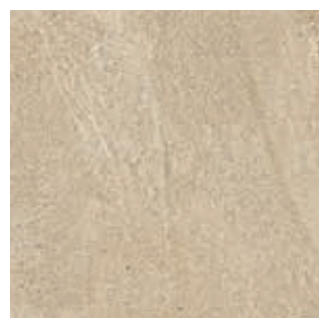

AMBER



OYSTER

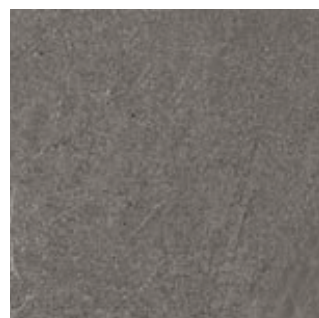

SLATE

14mm

NATURAL HONED BLAZED

RETTIFICATO RECTIFIED

60x120 cm 24"x48"	90x90 cm 36"x36"	60x60 cm 24"x24"	30x60 cm 12"x24"
NATURAL HONED BLAZED	NATURAL HONED	NATURAL HONED BLAZED	NATURAL HONED BLAZED

PEZZI SPECIALI SPECIAL PIECES

90x7,2 cm 36"x27/8"	60x7,2 cm 24"x27/8"	120x34 cm 48"x133/8"	120x34 cm 48"x133/8"	120x34 cm 48"x133/8"
NATURAL HONED Battiscopa con bisello Skirting	BLAZED Battiscopa con bisello Skirting	NATURAL HONED BLAZED Gradino inciso con righe Step tread with grooves	NATURAL BLAZED Gradone Plus bordo Step tread Plus	NATURAL Gradone Plus angolo Destro/Sinistro Step tread Plus Right/Left corner

Kerlite 5plus

NATURAL

5,5 mm RETTIFICATO RECTIFIED

100x300 cm 39"x118"	100x250 cm 39"x98 1/2"	100x100 cm 39"x39"	50x100 cm 19 1/2"x39"

20mm

NATURAL FIAMMATA

RETTIFICATO RECTIFIED

60x120 cm 24"x48"	90x90 cm 36"x36"
FIAMMATA	FIAMMATA

PEZZI SPECIALI SPECIAL PIECES

60x15 cm 24"x6"	60x30 cm 24"x13 3/8"
FIAMMATA Elemento Griglia Grill Component	FIAMMATA Gradone costa retta rigato con gocciolatoio Step tread straight edge with grooves and drip flap

RESISTENZA ALLO SCIVOLAMENTO
SLIP RESISTANCE
R11 BLAZED, FIAMMATA
R10 NATURAL (KERLITE - 14mm)

STONALIZZAZIONE
DESHADING
V2

RESISTENZA ALL'ABRASIONE PROFONDA
DEEP ABRASION RESISTANCE
143 mm³ 14mm - 20mm
175 mm³ KERLITE
VALORE MEDIO - AVERAGE VALUE

VISIBILITÀ DELLE IMPRONTE
TREAD MARK VISIBILITY
A HONED
B FIAMMATA, BLAZED, NATURAL (KERLITE - 14mm)

FACILITÀ DI PULIZIA
CLEANING EASINESS
1 HONED
2 FIAMMATA, BLAZED, NATURAL (KERLITE - 14mm)

PROTECT
ANTIBATTERICO - ANTIMICROBIAL
14 mm NATURAL, HONED
KERLITE

GARANZIA 20 ANNI
20 YEARS GUARANTEE
RESIDENZIALE E PUBBLICO
RESIDENTIAL AND PUBLIC



Liscia e piacevole al tatto. Una batteria di mole diamantate a granulometria decrescente esercita sulla superficie della piastrella una lappatura spinta, che rende la finitura honed liscia e piacevole al tatto e le dona il caratteristico riflesso semi lucido.

Particularly smooth and pleasant to touch. A set of diamond discs, which range from the coarsest to the finest, exert a vigorous lapping action on the surface of the tile to make the honed finish particularly smooth and pleasant to touch and to offer a characteristic demi-gloss appearance.

Lisse et agréable au toucher. Une série de meules diamantées à granulométrie décroissante exerce sur la surface du carreau un polissage prononcé, qui rend la finition honed lisse et agréable au toucher, et lui donne un reflet semi-brillant caractéristique.

Glatt und angenehm auf der haut. Ein satz kleiner werdender diamantschleifscheiben übt auf der fliesenoberfläche einen starken schliff aus, der die feinarbeitung honed glatt und angenehm auf der haut macht und ihr den charakteristischen halbgänzenden widerschein verleiht.



Questa superficie è ottenuta da calchi ricavati da pietre naturali. È una lavorazione possibile solo su alcune pietre dalle caratteristiche idonee, la cui superficie viene investita da un getto di fiamma viva a elevate temperature e subito dopo raffreddate ad acqua. Lo shock termico provoca la dilatazione della pietra e la conseguente rugosità tipica di questa finitura.

This surface has been faithfully created using molds from natural stones and can only be performed on certain types of stone. It consists of singeing the surface of the stone with a flame jet and then plunging the stone into water to obtain immediate cooling. The abrupt temperature change makes the stone expand and the result is a typically rough texture.

Cette surface est obtenue à partir de matrices de pierres naturelles. Cette élaboration n'est possible que sur certaines pierres dotées de caractéristiques spécifiques, dont la surface est soumise à un jet de flamme vive à hautes températures, avant d'être immédiatement refroidie à l'eau. Le choc thermique dilate la pierre en lui conférant la rugosité caractéristique de cette finition.

Diese oberfläche wird aus natursteinprägungen gewonnen. Dabei handelt es sich um eine arbeitung, die nur für die steine mit den richtigen eigenschaften in frage kommt und die bei hohen temperaturen zuerst den kontakt der oberfläche mit einer lodernden flamme und sofort danach mit abkühlendem wasser vorsieht. Der thermische schock bewirkt die ausdehnung des steins und die damit verbundene, für diese feinarbeitung typische rauheit.





CLAY NATURAL | 5,5 mm | 100x300 cm 39"x118"



CLAY HONED RETT. | 14 mm | 60x120 cm 24"x48"



OYSTER HONED RETT. | 14 mm | 60x120 cm 24"x48"



OYSTER FIAMMATA RETT. | 20 mm | 60x120 cm 24"x48"



OYSTER FIAMMATA RETT. | 20 mm | 60x120 cm 24"x48"



PIETRA D'ISEO

DECORATIVE STONE

CEPPO | 6,5 mm | 120x260 cm 48"x102"

PIETRA D'ISEO



CEPPPO

kerlite
6plus

NATURALE



6,5 mm
RETTIFICATO
RECTIFIED



120x260 cm
48"x102"



120x120 cm
48"x48"



60x120 cm
24"x48"



60x60 cm
24"x24"

20mm

BOCCIARDATA



RETTIFICATO
RECTIFIED



75x75 cm
30"x30"

PEZZI SPECIALI
SPECIAL PIECES



75x15 cm
30"x6"
Elemento Griglia
Grill Component



75x34 cm
30"x13³/₈"
Gradone costa retta rigato con gocciolatoio
Step tread straight edge with grooves and drip flap

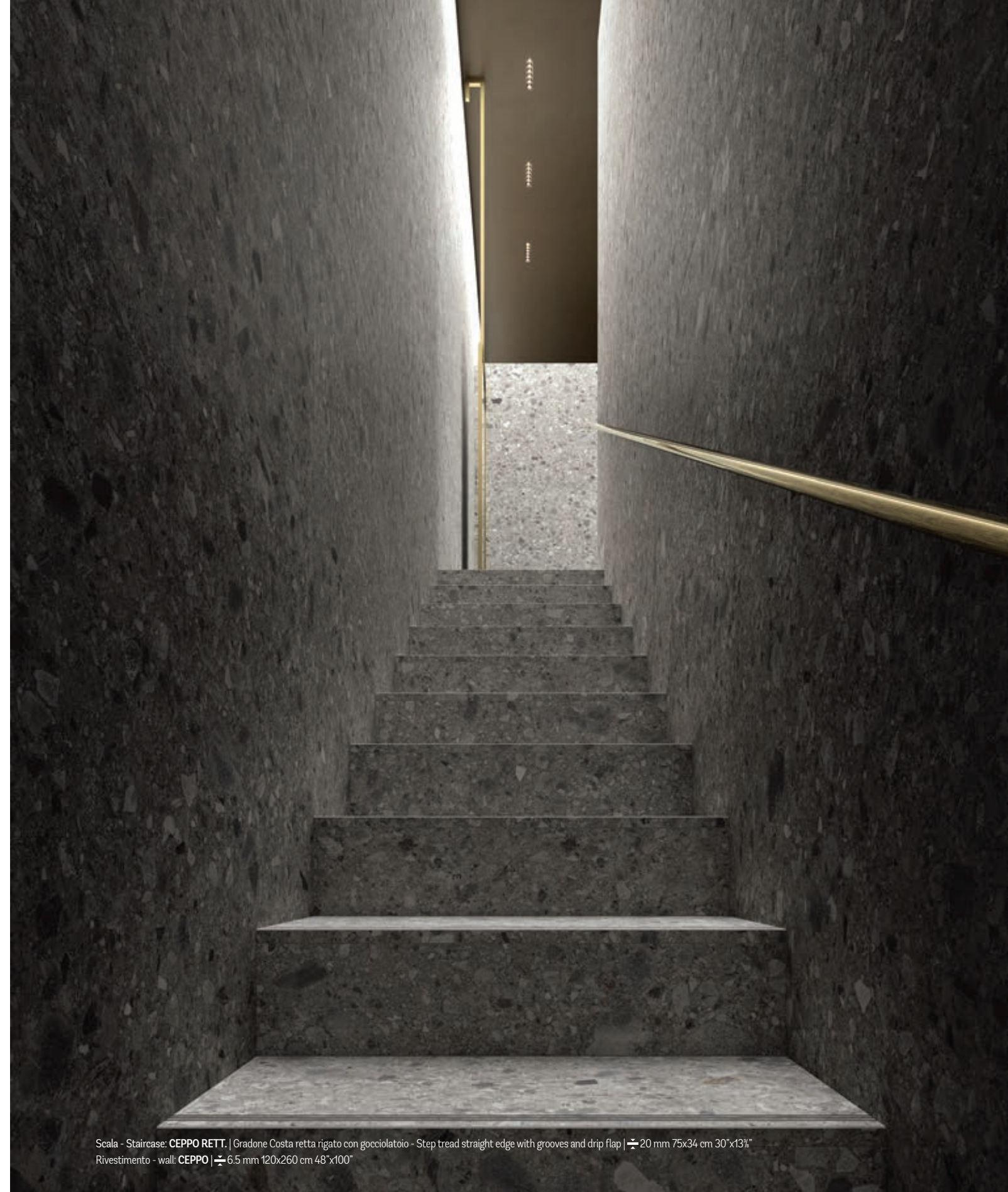

Scala - Staircase: CEPPPO RETT. | Gradone Costa retta rigato con gocciolatoio - Step tread straight edge with grooves and drip flap | 20 mm 75x34 cm 30"x13³/₈"
Rivestimento - wall: CEPPPO | 6.5 mm 120x260 cm 48"x100"



**RESISTENZA ALLO
SCIVOLAMENTO
SLIP RESISTANCE**
R10 NATURALE (KERLITE)
R12 BOCCIARDATA (20mm)



**STONALIZZAZIONE
DESHADING**
V2



**RESISTENZA ALL'ABRASIONE
PROFONDA
DEEP ABRASION RESISTANCE**
143 mm³ 20mm
175 mm³ KERLITE
VALORE MEDIO - AVERAGE VALUE



**VISIBILITÀ DELLE IMPRONTE
TREAD MARK VISIBILITY**
A NATURALE (KERLITE)
B BOCCIARDATA (20MM)



**FACILITÀ DI PULIZIA
CLEANING EASINESS**
1 NATURALE (KERLITE)
2 BOCCIARDATA (20MM)

PROTECT
ANTIBATTERICO - ANTIMICROBIAL
KERLITE



**GARANZIA 20 ANNI
20 YEARS GUARANTEE**
RESIDENZIALE E PUBBLICO
RESIDENTIAL AND PUBLIC



Pavimento - floor: CEPP0 | 6.5 mm 120x260 cm 48"x100" | Rivestimento - wall: CEPP0 | 6.5 mm 120x260 cm 48"x100" - 60x120 cm 24"x48"



Rivestimento - wall: CEPP0 | 6.5 mm 120x260 cm 48"x100" | Pavimento - floor: CEPP0 | 6.5 mm 120x260 cm 48"x100"



SECRET STONE

TIMELESS BEAUTY

PRECIOUS BEIGE NATURAL RETT. |  14 mm | 60x60 cm 24"x24" - 30x60 cm 12"x24"

SECRET STONE

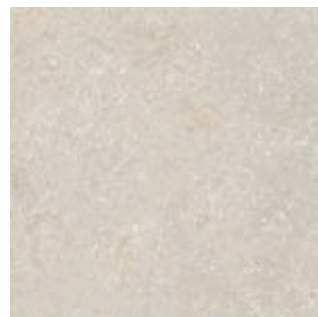

MYSTERY WHITE



PRECIOUS BEIGE



SHADOW GREY



RARE DARK

14mm

NATURAL HONED GRIP

RETTIFICATO RECTIFIED

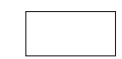

60x120 cm
24"x48"
NATURAL
HONED



90x90 cm
36"x36"
NATURAL
HONED



60x60 cm
24"x24"
NATURAL
HONED
GRIP



30x60 cm
12"x24"
NATURAL
HONED
GRIP

PEZZI SPECIALI SPECIAL PIECES

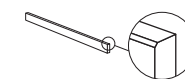

90x7,2 cm
36"x2 7/8"
NATURAL
HONED
Battiscopa con bisello
Skirting

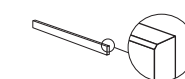

60x7,2 cm
36"x2 7/8"
NATURAL
HONED
Battiscopa con bisello
Skirting

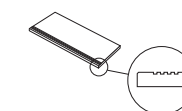

60x34 cm
24"x13 3/8"
GRIP
Gradino inciso con righe
Step tread with grooves

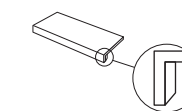

60x34 cm
24"x13 3/8"
GRIP
Gradone Plus bordo
Step tread Plus

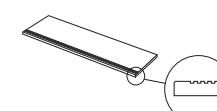

120x34 cm
48"x13 3/8"
NATURAL
HONED
Gradino inciso con righe
Step tread with grooves

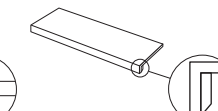

120x34 cm
48"x13 3/8"
NATURAL
Gradone Plus bordo
Step tread Plus

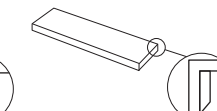

120x34 cm
48"x13 3/8"
NATURAL
Gradone Plus angolo Destro/Sinistro
Step tread Plus Right/Left corner

20mm

BOCCIARDATA

RETTIFICATO RECTIFIED



60x120 cm
24"x48"
BOCCIARDATA



90x90 cm
36"x36"
BOCCIARDATA



60x15 cm
24"x6"
BOCCIARDATA
Elemento Griglia
Grill Component

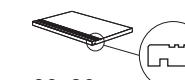

60x30 cm
24"x13 3/8"
BOCCIARDATA
Gradone costa retta rigato
con gocciolatoio
Step tread straight edge with
grooves and drip flap



**RESISTENZA ALLO
SCIVOLAMENTO
SLIP RESISTANCE**
R11 GRIP, BOCCIARDATA
R10 NATURAL



**STONALIZZAZIONE
DESHADING**
V2



**RESISTENZA ALL'ABRASIONE
PROFONDA
DEEP ABRASION RESISTANCE**
143 mm³
VALORE MEDIO - AVERAGE VALUE



**VISIBILITÀ DELLE IMPRONTE
TREAD MARK VISIBILITY**
A HONED
B NATURAL, GRIP, BOCCIARDATA



**FACILITÀ DI PULIZIA
CLEANING EASINESS**
2

PROTECT
ANTIBATTERICO - ANTIMICROBIAL
NATURAL
HONED



**GARANZIA 20 ANNI
20 YEARS GUARANTEE**
RESIDENZIALE E PUBBLICO
RESIDENTIAL AND PUBLIC



MYSTERY WHITE HONED RETT. | ± 14 mm | 90x90 cm 36"x36"



BEIGE BOCCIARDA RETT. | 20 mm | 60x120 cm 24"x48"



SHADOW GREY NATURAL RETT. | 14 mm | 60x120 cm 24"x48"



SHADOW GREY HONED RETT. | 14 mm | 60x120 cm 24"x48"

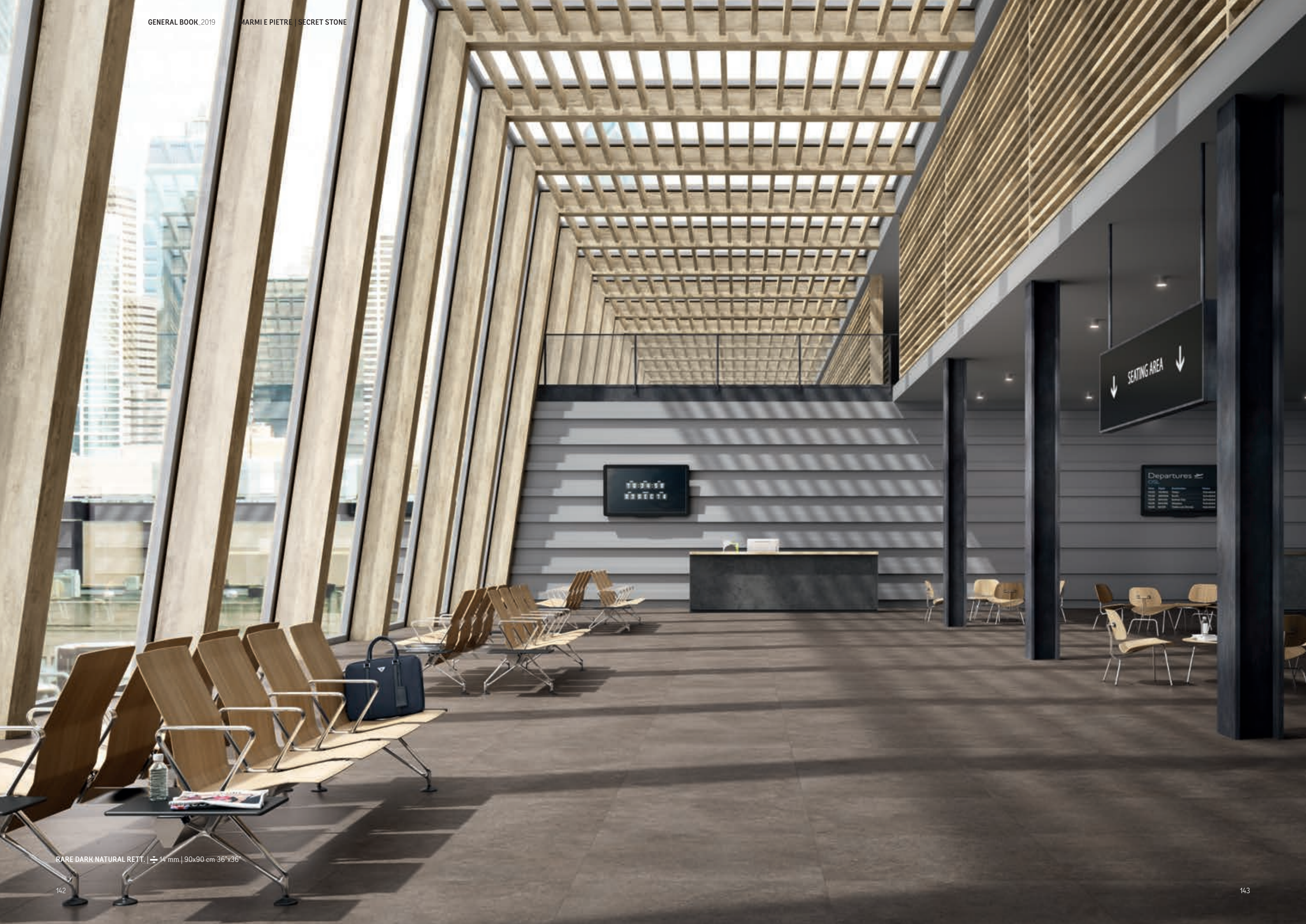

RARE DARK NATURAL RETT. | 14 mm | 90x90 cm 36"x36"



STONEQUARTZ

THE NORTHERN STONE

OSLO FIAMMATA RETT. | 14 mm | 60x60 cm 24"x24"

STONEQUARTZ



BERGEN



ARTIC

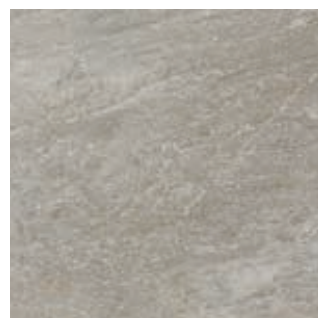

NORDIC



OSLO

14mm

FIAMMATA

RETTIFICATO
RECTIFIED



60x60 cm
24"x24"

FIAMMATA



30x60 cm
12"x24"

FIAMMATA

PEZZI SPECIALI
SPECIAL PIECES

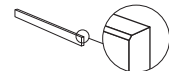

60x7,2 cm
24"x2 7/8"

FIAMMATA
Battiscopa con bisello
Skirting

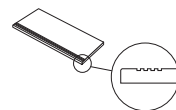

60x34 cm
24"x13 3/8"

FIAMMATA
Gradino inciso con righe
Step tread with grooves

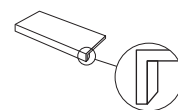

60x34 cm
24"x13 3/8"

FIAMMATA
Gradone Plus bordo
Step tread Plus

20mm

FIAMMATA

RETTIFICATO
RECTIFIED



60x120 cm
24"x48"

FIAMMATA



60x60 cm
24"x24"

FIAMMATA

PEZZI SPECIALI
SPECIAL PIECES



60x15 cm
24"x6"

FIAMMATA
Elemento Griglia
Grill Component

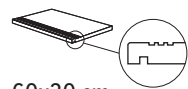

60x30 cm
24"x13 3/8"

FIAMMATA
Gradone costa retta rigato
con gocciolatoio
Step tread straight edge with
grooves and drip flap



ARTIC FIAMMATA RETT. | 14 mm | 60x60 cm 24"x24"



RESISTENZA ALLO
SCIVOLAMENTO
SLIP RESISTANCE

R11



V3
ARTIC
OSLO

V4
NORDIC
BERGEN

STONALIZZAZIONE
DESHADING



RESISTENZA ALL'ABRAZIONE
PROFONDA
DEEP ABRASION RESISTANCE

143 mm³
VALORE MEDIO - AVERAGE VALUE



VISIBILITÀ DELLE IMPRONTE
TREAD MARK VISIBILITY

B



FACILITÀ DI PULIZIA
CLEANING EASINESS

2



GARANZIA 20 ANNI
20 YEARS GUARANTEE

RESIDENZIALE E PUBBLICO
RESIDENTIAL AND PUBLIC



NORDIC FIAMMATA RETT. | 20 mm | 60x120 cm 24"x48"



Questa superficie così unica e riconoscibile è fedelmente ottenuta da calchi ricavati da pietre naturali. La fiammata è una lavorazione possibile solo su alcune pietre dalle caratteristiche idonee (come i graniti, che contengono elevate quantità di quarzo), la cui superficie viene investita da un getto di fiamma viva a elevate temperature e subito dopo raffreddate ad acqua. Lo shock termico provoca la dilatazione della pietra e la conseguente rugosità tipica di questa finitura.

This unique and recognisable surface has been faithfully created using molds from natural stones. Flash effect texturing can only be performed on certain types of stone (granite, for instance, that has a high content of quartz). It consists of singeing the surface of the stone with a flame jet and then plunging the stone into water to obtain immediate cooling. The abrupt temperature change makes the stone expand and the result is a typically rough texture.

Cette surface, unique et typique, est le résultat fidèle de l'utilisation des matrices de pierres naturelles. Le flammage ne peut être réalisé que sur certaines pierres dotées de caractéristiques spécifiques (telles que les granits très riches en quartz), dont la surface est soumise à un jet de flammes vives à très hautes températures puis immédiatement refroidie à l'eau. Le choc thermique provoque la dilatation de la pierre en conférant la rugosité typique de cette finition.

Diese wirklich einzigartige und erkennbare Oberfläche wird durch dem Abdruck von Natursteine getreu erzeugt. Die Flammung ist eine Bearbeitung, die nur auf einigen Steinen mit passenden Eigenschaften möglich ist (wie die Granite, die hohe Quarzmengen enthalten); ihre Oberfläche wird dabei mit einem offenen Flammenstrahl mit hohen Temperaturen behandelt und gleich danach mit Wasser abgekühlt. Der Temperaturschock verursacht die Ausdehnung des Gesteins und demzufolge die typische Rauigkeit dieser Bearbeitung.



BERGEN FIAMMATA RETT. | ± 20 mm | 60x60 cm 24"x24"



NORDIC FIAMMATA RETTA | 20 mm | 60x60 cm 24"x24"



ARTIC FIAMMATA RETT | 20 kg | 60,60 cm 24 x24"



VANITY

LUXURY MARBLE

Pavimento - floor: BIANCO LUCE TOUCH | 6,5 mm | 120x120 cm 48"x48"
Rivestimento - wall: BIANCO STATUARIO GLOSSY BOOKMATCH | 6,5 mm | 120x260 cm 48"x102"

VANITY

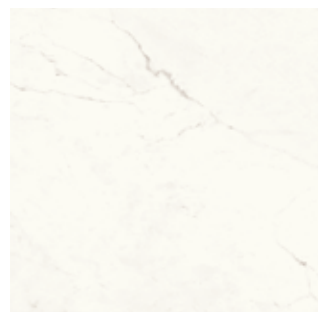

BIANCO LUCE

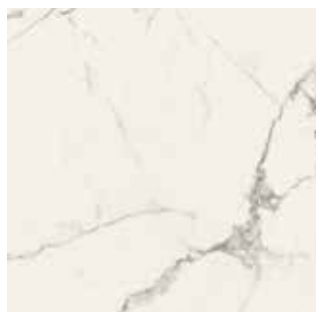

BIANCO STATUARIO



DARK BROWN

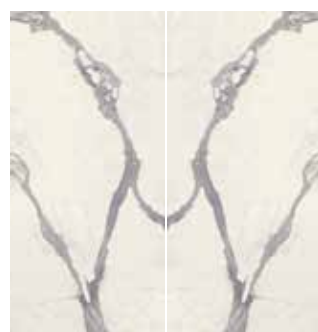

**BIANCO STATUARIO
BOOKMATCH 120X260 (A+B)**

Come per il materiale naturale anche la grafica di BOOKMATCH può mostrare discontinuità di vena nel passaggio da una lastra all'altra. Per questo motivo differenze di allineamento devono essere considerate come caratteristica del prodotto.

As with the natural material, the graphic design of BOOKMATCH may result in discontinuities in the veining between panels. Discontinuities are not defects, but are characteristic of the product.

Le décor BOOKMATCH s'inspirant d'un matériau naturel, celui-ci peut présenter des veines discontinues qui ne se correspondent pas parfaitement lorsque les dalles sont mises côte à côte. Pour cette raison, les différences d'alignement doivent être considérées comme une caractéristique du produit.

Wie beim natürlichen Material kann auch die Grafik von BOOKMATCH eine Maserungs-Diskontinuität im Übergang von einer Platte zur anderen aufweisen. Aus diesem Grund sind Ausrichtungsunterschiede als Charakteristik des Produkts zu betrachten.

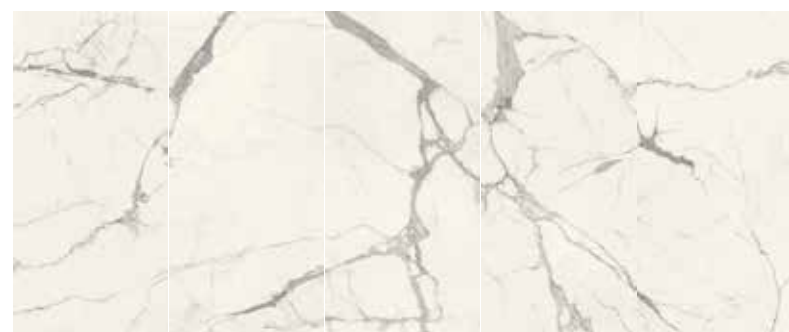

**BIANCO STATUARIO
CHAIN**

Acquistabile solo a composizione completa
Can only be purchased as a complete composition
Cette composition ne peut être vendue
séparément, mais en un ensemble unique
Nur in voller Zusammensetzung erhältlich

kerlite
6plus

GLOSSY



TOUCH



6,5 mm
RETTIFICATO
RECTIFIED



120x260 cm
48"x102"

GLOSSY
TOUCH



120x120 cm
48"x48"

GLOSSY
TOUCH



**STONIZZAZIONE
DESHADING**

V2



**RESISTENZA ALL'ABRASIONE
PROFONDA
DEEP ABRASION RESISTANCE**

175 mm³
VALORE MEDIO - AVERAGE VALUE



**VISIBILITÀ DELLE IMPRONTE
TREAD MARK VISIBILITY**

B



**FACILITÀ DI PULIZIA
CLEANING EASINESS**

2

P R O T E C T
ANTIBATTERICO - ANTIMICROBIAL



**GARANZIA 10 ANNI
10 YEARS GUARANTEE**

RESIDENZIALE
RESIDENTIAL



Rivestimento - wall: BIANCO STATUARIO GLOSSY BOOKMATCH | 6,5 mm | 120x260 cm 48"x102"



Pavimento - floor: **BIANCO LUCE TOUCH** | 6,5 mm | 120x120 cm 48"x48"
Rivestimento - wall: **BIANCO STATUARIO GLOSSY** | 6,5 mm | 120x260 cm 48"x104" Countertop: **DARK BROWN GLOSSY**



GLOSSY

Effetto lucido e brillante per una finitura che fa risplendere le superfici effetto marmo di Vanity evidenziando un'attenzione per il dettaglio unica nel suo genere. Un particolare trattamento di lucidatura, frutto di un'avanzata tecnologia, restituisce nuova vita ad un materiale tanto bello quanto delicato, per renderlo versatile, inalterabile nel tempo e di facile manutenzione.

A glossy and brilliant finish that makes Vanity's marble-effect surfaces radiant, and highlights the unique attention to detail. A special polishing method, the result of advanced technology, gives new life to the original, beautiful and delicate material, making it versatile, durable and easy to maintain.

Une finition brillante et brillante qui fait des surfaces à effet marbre de Vanity rayonnante, et souligne l'attention unique portée aux détails. Une méthode de polissage spéciale, résultat d'une technologie avancée, donne de nouvelles vie à la matière originale, belle et délicate, ce qui le rend polyvalent, durable et facile à entretenir.

Eine glänzende und brillante Oberfläche, die Vanity Marmoreffektflächen hervorhebt strahlt und unterstreicht die einzigartige Liebe zum Detail. Eine spezielle Poliermethode, das Ergebnis fortschrittlicher Technologie, gibt Neues das Leben zum ursprünglichen, schönen und zarten Material, das es vielseitig macht, langlebig und pflegeleicht.



Pavimento - floor: BIANCO LUCE TOUCH | ➔ 6,5 mm | 120x120 Countertop: DARK BROWN GLOSSY



Pavimento - floor: **BIANCO STATUARIO GLOSSY** | \pm 6,5 mm | 120x120 cm 48"x48"
Rivestimento - Wall: **DARK BROWN TOUCH** | \pm 6,5 mm | 120x260 cm 48"x102" - **BIANCO STATUARIO GLOSSY** | \pm 6,5 mm | 120x260 cm 48"x102"



Pavimento - floor: **BIANCO STATUARIO TOUCH** | ± 6,5 mm | 120x260 cm 48"x102"
Rivestimento - Wall: **BIANCO STATUARIO TOUCH** | ± 6,5 mm | 120x260 cm 48"x102" -Desk: **DARK BROWN GLOSSY** | ± 6,5 mm



TOUCH

Questa speciale finitura opaca trasferisce una piacevole sensazione tattile e una grande profondità alle venature e alle sfumature di colore che ne attraversano la superficie: ideale per applicazioni a pavimento e rivestimento di grande fascino ed eleganza.

This special matt finish delivers a pleasant tactile sensation and great depth to the veining with nuances of colour flowing across the surface. It is ideal for floors and walls of great charm and elegance.

Cette finition mate spéciale procure une sensation tactile agréable et une excellente profondeur au veinage avec des nuances de couleur qui coule sur la surface. Il est idéal pour les sols et les murs de charme et d'élégance.

Diese spezielle matte Oberfläche vermittelt ein angenehmes Tastgefühl und ist großartig Tiefe bis zur Vene mit Farbnuancen, die über die Oberfläche fließen. Es ist Ideal für Böden und Wände von großem Charme und Eleganz.



Pavimento - floor: BIANCO LUCE TOUCH | 6,5 mm | 120x120 cm 48"x48"



MATERIA E COLORE

MATTER AND COLOUR | MATIÈRE ET COULEUR | MATERIE UND FARBE



BLACK-WHITE

ABSOLUTE STYLE

BLACK SILK | ± 5,5 mm | 100x100 cm 39"x39"

BLACK-WHITE

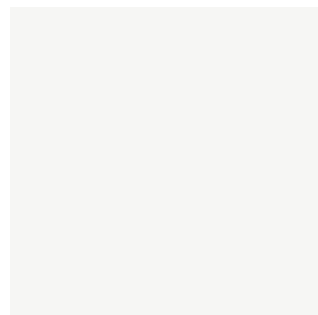

ULTRAWHITE

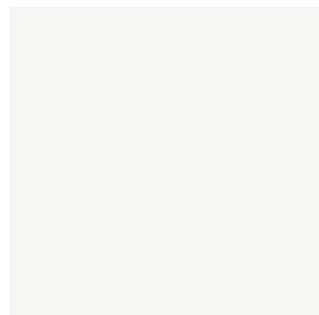

WHITE

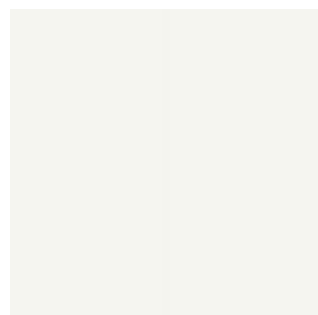

SNOW

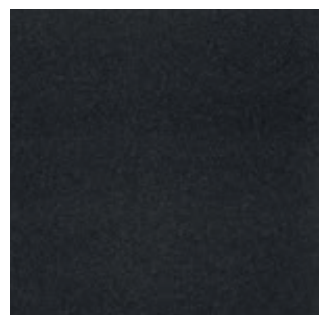

BLACK¹



GLOSSY/SILK  

5,5 mm
RETTIFICATO
RECTIFIED



100x300 cm*
39"x118"
GLOSSY/SILK



100x100 cm*
39"x39"
GLOSSY/SILK



50x100 cm*
19 1/2"x39"
GLOSSY/SILK

* DISPONIBILI IN | AVAILABLE IN: **ULTRAWHITE - BLACK**



3,5 mm
RETTIFICATO
RECTIFIED



100x300 cm**
39"x118"



100x100 cm**
39"x39"



50x100 cm**
19 1/2"x39"

** DISPONIBILI IN | AVAILABLE IN: **SNOW-BLACK-WHITE**



STONALIZZAZIONE
DESHADING

V1



RESISTENZA ALL'ABRAZIONE
PROFONDA
DEEP ABRASION RESISTANCE

175 mm³
VALORE MEDIO - AVERAGE VALUE



VISIBILITÀ DELLE IMPRONTE
TREAD MARK VISIBILITY

B



FACILITÀ DI PULIZIA
CLEANING EASINESS

2

PROTECT
ANTIBATTERICO - ANTIMICROBIAL

KERLITE 5PLUS



GARANZIA 20 ANNI
20 YEARS GUARANTEE

RESIDENZIALE | RESIDENTIAL
KERLITE 3PLUS



GARANZIA 10 ANNI
10 YEARS GUARANTEE

PUBBLICO | PUBLIC KERLITE 3PLUS - KERLITE 5PLUS SILK
RESIDENZIALE | RESIDENTIAL KERLITE 5PLUS



ULTRAWHITE GLOSSY | 5,5 mm | 100x300 cm 39"x120"



WHITE | ± 3.5 mm | 100x100 cm 39"x39"



ULTRAWHITE GLOSSY | 5.5 mm | 100x100 cm 39"x39"



SNOW | 3.5 mm | 100x300 cm 39"x118"

CEMENT PROJECT

URBAN SPACE

Pavimento - Floor: **METAL, IRON** | 5,5 mm | 100x100 cm 39"x39"
Rivestimento - Wall: **COLOR-30 WORK** | 5,5 mm | 100x300 cm 39"x118" - Soffitto - Ceiling: **COLOR-10 WORK** | 5,5 mm | 100x300 cm 39"x118"

CEMENT PROJECT

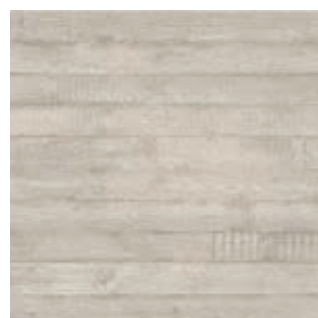

COLOR-10 WORK

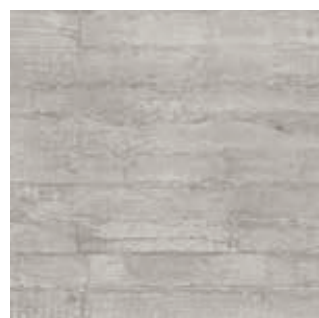

COLOR-20 WORK



COLOR-30 WORK

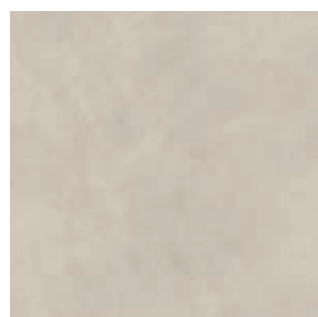

COLOR-10 CEM



COLOR-20 CEM



COLOR-30 CEM

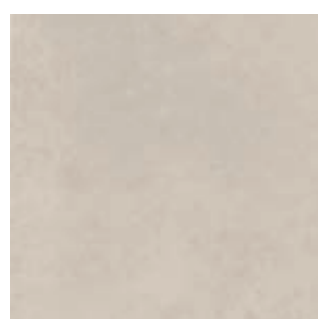

COLOR-10 LAND



COLOR-20 LAND

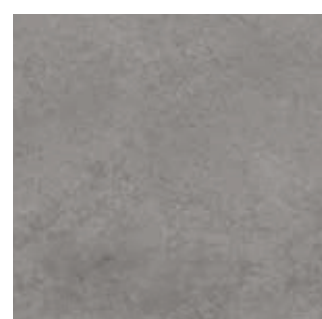

COLOR-30 LAND

14mm

LAND NATURALE LAND LAPPATA

RETTIFICATO
RECTIFIED



60x120 cm
24"x48"

LAND NATURALE
LAND LAPPATA



90x90 cm
36"x36"

LAND NATURALE
LAND LAPPATA



60x60 cm
24"x24"

LAND NATURALE
LAND LAPPATA

PEZZI SPECIALI
SPECIAL PIECES

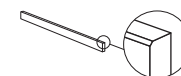

90x7,2 cm
36"x2 7/8"

LAND NATURALE
LAND LAPPATA
Battiscopa con bisello
Skirting

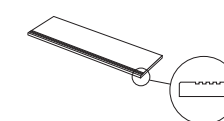

120x34 cm
48"x13 3/8"

LAND NATURALE
LAND LAPPATA
Gradino inciso con righe
Step tread with grooves

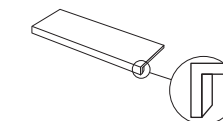

120x34 cm
48"x13 3/8"

LAND NATURALE
LAND LAPPATA
Gradone Plus bordo
Step tread Plus

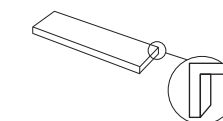

120x34 cm
48"x13 3/8"

LAND NATURALE
LAND LAPPATA
Gradone Plus angolo Destro/Sinistro
Step tread Plus Right/Left corner

Kerlite 5plus

CEM WORK

5,5 mm

RETTIFICATO
RECTIFIED



100x300 cm
39"x118"

CEM
WORK



100x100 cm
39"x39"

CEM



50x150 cm
19 1/2"x59"

WORK

20mm

WORK

RETTIFICATO
RECTIFIED



60x120 cm
24"x48"

WORK

PEZZI SPECIALI
SPECIAL PIECES



60x15 cm
24"x6"

WORK
Elemento Griglia
Grill Component



60x30 cm
24"x13 3/8"

WORK
Gradone costa retta rigato
con gocciolatoio
Step tread straight edge with
grooves and drip flap



RESISTENZA ALLO
SCIVOLAMENTO
SLIP RESISTANCE

R12 WORK 20mm
R10 LAND NATURALE, KERLITE WORK
R9 KERLITE CEM



STONIZZAZIONE
DESHADING

V2



RESISTENZA ALL'ABRASIONE
PROFONDA
DEEP ABRASION RESISTANCE

143 mm³ 14mm, 20mm
VALORE MEDIO - AVERAGE VALUE
175 mm³ KERLITE
VALORE MEDIO - AVERAGE VALUE



VISIBILITÀ DELLE IMPRONTE
TREAD MARK VISIBILITY

A LAND LAPPATA, CEM
B LAND NATURALE, WORK (KERLITE - 20mm)



FACILITÀ DI PULIZIA
CLEANING EASINESS

1 CEM
2 LAND NATURALE, LAND LAPPATA,
WORK (KERLITE - 20mm)

PROTECT
ANTIBATTERICO - ANTIMICROBIAL

14 mm - KERLITE 5PLUS



GARANZIA 20 ANNI
20 YEARS GUARANTEE

RESIDENZIALE E PUBBLICO
RESIDENTIAL AND PUBLIC



COLOR-20 LAND NATURALE RETT. | 14 mm | 90x90 cm 36"x36"



Land si ispira alle formelle di cemento realizzate a mano ottenute per colaggio della miscela cementizia, all'interno di appositi vassoi. La superficie riproduce fedelmente tracce di gocce d'acqua, macchie e aloni di varie dimensioni e sfumature tipiche del processo di essiccazione. Graffi e puntini delicati donano al pavimento un particolare e gradevole aspetto vissuto. Land é un gres porcellanato spessorato di 14mm, colorato a tutta massa, decorato in superficie con tecnologia digitale ad alta definizione e proposto in due finiture: superficie Naturale antiscivolo R10-B e superficie Lappata morbida al tatto.

Land is inspired by hand-made cement bricks obtained by casting the cement mixture, in special trays. The surface faithfully reproduces traces of water droplets, stains and halos of various sizes and shades typical of the drying process. Delicate scratches and dots give the floor a particular and pleasant aspect. Land is a 14mm-thick porcelain stoneware product, coloured throughout, with surface decorations that use high definition digital technology, available in two finishes: the Natural anti-slip surface R10-B and the Lappata surface that is smooth to the touch.

Land s'inspire des dalles que l'on pourrait obtenir en coulant le ciment à la main dans un bac à gâcher. En surface, des traces de gouttes d'eau, des taches et des auréoles de différentes dimensions et nuances typiques pouvant se manifester durant la phase de séchage, ont été fidèlement reproduites. Des rayures et une constellation de minuscules points apportent cette touche particulière et authentique au sol. Land est un grès cérame de 14 mm d'épaisseur, coloré en pleine masse, décoré en surface grâce à la technologie numérique à haute définition, et disponible en deux finitions : la surface Naturelle antidérapante R10-B et Lappata douce au toucher.

Land inspiriert sich an der handgefertigten Zementschalung, die durch das Gießen der Zementmischung in spezielle Schalen erhalten wird. Die Oberfläche gibt die für den Trocknungsprozess typischen Spuren von Wassertropfen, Flecken und Schatten mit ihren verschiedenen Größen und Schattierungen wahrheitsgetreu wieder. Feine Kratzer und kleine Punkte verleihen dem Fußboden einen besonderen und angenehm verlebten Look. Land ist ein 14 mm dickes durchgefärbtes Feinsteinzeug, auf der Oberfläche mit hochauflösender digitaler Technologie dekoriert und in zwei Ausführungen erhältlich: Naturale rutschfest R10-B und Lappata, die ein weiches tastgefühl vermittelt.



Cem si ispira ai pavimenti di cemento spatolati a mano. La superficie riproduce le tracce dei movimenti dell'artigiano che stende e spalma l'impasto cementizio a terra. La particolarità del materiale é costituita dalle infinite sfumature di grigio e da un'affascinante e inedito riflesso lucido/opaco che assume in controtuce un carattere unico e distintivo.

Cem is inspired by cement applied by hand with a spatula. The surface reproduces traces of the craftsman's movements that extend and spread the cement on the ground. The uniqueness of the series is constituted by the infinite shades of grey and a fascinating and special glossy/opaque reflection on the surface that gives the product a unique and distinctive character.

Cem s'inspire des sols en ciment étalés à la main. La surface reproduit les traces des mouvements que pourrait laisser l'artisan lorsqu'il répand et étale le ciment sur la surface. La particularité de cette série est qu'elle propose d'infinies nuances de gris et arbore des reflets brillants et opaques en surface qui, en contre-jour, dévoilent un caractère unique et distinctif fascinant.

Cem inspiriert sich an den von Hand verspachtelten Zementfußböden. Die Oberfläche reproduziert die Spuren der Bewegungen des Handwerkers, der den Zement auf dem Boden verteilt und verstreicht. Die Besonderheit des Materials besteht aus den unendlichen Grautönen und einer faszinierenden und besonderen glänzend-matten Reflexion der Oberfläche, die im Gegenlicht einen einzigartigen und unverwechselbaren Charakter annimmt.

COLOR-10 CEM | 5,5 mm | 100x300 cm 39"x118"



Questa superficie si ispira ai tradizionali casseri lignei realizzati dai carpentieri per le costruzioni in cemento armato e si caratterizza per impronte digitali uniche e irripetibili impresse nel cemento, che lasciano tracce indelebili delle fibre e dei nodi del legno. Work è una superficie capace di ricreare l'atmosfera tipica degli edifici metropolitani, pensata per rendere unici gli spazi residenziali, commerciali o pubblici, sia in interno che esterno, a pavimento, parete o soffitto e ideale anche per facciate ventilate.

This surface is inspired by traditional wood form-work created by carpenters for reinforced concrete structures and is characterized by unique and one-of-a-kind imprints in the cement, which leave indelible traces of the wood's fibres and knots. Work is a surface capable of recreating the typical atmosphere of city buildings, designed to make both the interiors and exteriors of residential, commercial, or public spaces unique, whether installed on the floor, wall, or ceiling, and is also perfect for ventilated facades.

La gamme s'inspire aux blocs de coffrage traditionnels en bois-ciment fabriqués par les charpentiers pour réaliser des constructions en béton armé. Sa surface exceptionnelle laisse apparaître des nœuds et les fibres du bois, témoignant de cette authenticité comme des signes indélébiles. Work est une surface capable de recréer l'atmosphère typique des édifices métropolitains, pensée pour rendre les espaces résidentiels, commerciaux et publics uniques. Nombreuses seront ses destinations d'usage, s'adaptant aussi bien en intérieur qu'en extérieur, au sol, sur les murs ou au plafond, jusqu'aux façades ventilées.

Diese Oberfläche inspiriert sich an den traditionellen Holzschalungen der Zimmerleute für Stahlbetonkonstruktionen und zeichnet sich durch die einzigartigen und unwiederholbaren Digitalabdrücke aus, die im Beton eingepreßt sind und unauslöschliche Spuren der Fasern und Knoten des Holzes hinterlassen. Work ist eine Oberfläche, in der Lage die typische Atmosphäre metropolitane Gebäude nachzubilden und dafür gedacht, die Wohn-, Gewerbe- oder öffentlichen Räume sowohl im Innen- als auch im Außenbereich, auf Fußböden, Wänden oder Decken einzigartig werden zu lassen. Work ist auch ideal für den Einsatz bei hinterlüfteten Fassaden.



the
ART
MUSEUM

Pavimento - Floor: **COLOR-30 LAND NATURALE RETT.** | 14 mm | 90x90 cm 36"x36"
Rivestimento - Wall: **COLOR-10 WORK** | 5,5 mm | 100x300 cm 39"x118" - **COLOR-20 WORK** | 5,5 mm | 100x300 cm 39"x118"



Pavimento - Floor: COLOR-20 LAND LAPPATA RETT. | 14 mm | 90x90 cm 36"x36" - Rivestimento - Wall: COLOR-20 CEM | 5,5 mm | 100x300 cm 39"x118"



Pavimento - Floor: COLOR-20 CEM | 5,5 mm | 100x300 cm 39"x118"
Rivestimento - Wall: COLOR-20 CEM | 5,5 mm | 100x300 cm 39"x118" - Soffitto | Ceiling: COLOR-20 WORK | 5,5 mm | 50x150 cm 13³/₈"x59"

BEST ESTE
CLASSIC HOTEL

Pavimento - Floor: **COLOR-10 LAND LAPPATA RETT.** | 14 mm | 60x120 cm 24"x48"
Rivestimento - Wall: **COLOR-10 WORK** | 5,5 mm | 100x300 cm 39"x118" - **FOREST, NOCE** | 5,5 mm | 33x100 cm 13"x118" -
Desk: **EXEDRA, RAIN GREY GLOSSY** | 5,5 mm | 100x300 cm 39"x118"



Pavimento - Floor: COLOR-20 WORK RETT. | \pm 20 mm | 60x120 cm 24"x48" Rivestimento - Wall: COLOR-20 WORK | \pm 5,5 mm | 100x300 cm 39"x118"



Pavimento - Floor: COLOR-20 WORK RETT. | \pm 20 mm | 60x120 cm 24"x48"
Rivestimento - Wall: COLOR-20 WORK | \pm 5,5 mm | 100x300 cm 39"x118"



MATERICA

NATURAL COLORS

TORTORA | 5,5 mm | 100x300 cm 39"x118"

MATERICA



BIANCO



AVORIO

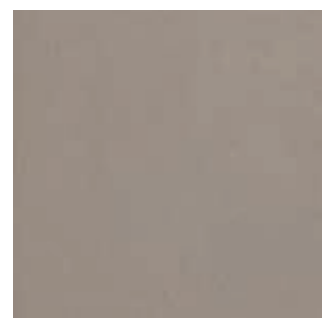

TORTORA



CEMENTO

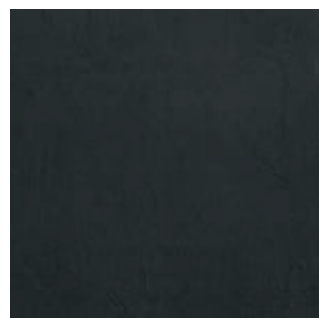

ARDESIA

kerlite
5plus



5,5 mm
RETTIFICATO
RECTIFIED



100x300 cm
39"x118"



100x250 cm
39"x98 1/2"



100x100 cm
39"x39"



50x100 cm
19 1/2"x39"



RESISTENZA ALLO
SCIVOLAMENTO
SLIP RESISTANCE

R9



STONALIZZAZIONE
DESHADING

V1



RESISTENZA ALL'ABRASIONE
PROFONDA
DEEP ABRASION RESISTANCE

175 mm²
VALORE MEDIO - AVERAGE VALUE



VISIBILITÀ DELLE IMPRONTE
TREAD MARK VISIBILITY

B ARDESIA, CEMENTO
C TORTORA, BIANCO, AVORIO



FACILITÀ DI PULIZIA
CLEANING EASINESS

2

PROTECT
ANTIBATTERICO - ANTIMICROBIAL



GARANZIA 20 ANNI
20 YEARS GUARANTEE

RESIDENZIALE E PUBBLICO



ARDESIA NATURALE RETT. | ± 5,5 mm | 50X100cm 19 1/2"x39"



AVORIO | 5,5 mm | 100x100 cm 39"x39"



CEMENTO | 5,5 mm | 100x100 cm 39"x39"



CEMENTO NATURALE RETT. | 5,5 mm | 100x100 cm 39"x39"



SABBIA | 5,5 mm | 50x150 cm 19 1/2"x60"

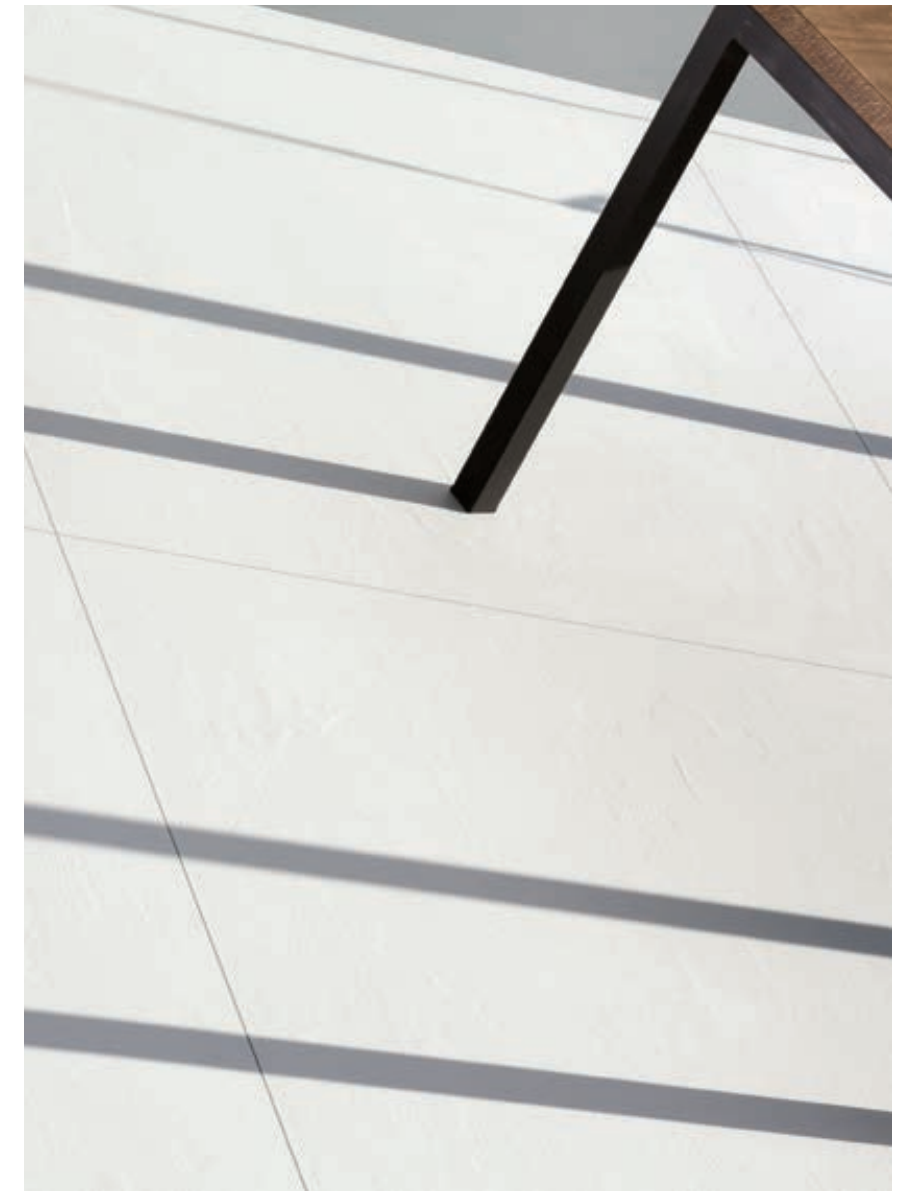

BIANCO NATURALE RETT. | 5,5 mm | 100x100 cm 39"x39"





METAL

METALLIC SLABS

IRON | 5,5 mm | 100x100 cm 39"x39"

METAL



IRIDIUM



CORTEN



IRON

kerlite
5plus



5,5 mm
RETTIFICATO
RECTIFIED



100x300 cm
39"x118"



100x100 cm
39"x39"



CORTEN | 5,5 mm | 100x300 cm 39"x118"



RESISTENZA ALLO SCIVOLAMENTO
SLIP RESISTANCE

R9 CORTEN, IRIDIUM



V1
IRIDIUM



V2
IRON



V3
CORTEN

STONALIZZAZIONE
DESHADING



RESISTENZA ALL'ABRASIONE PROFONDA
DEEP ABRASION RESISTANCE

175 mm²
VALORE MEDIO - AVERAGE VALUE



VISIBILITÀ DELLE IMPRONTE
TREAD MARK VISIBILITY

A IRIDIUM, IRON
B CORTEN



FACILITÀ DI PULIZIA
CLEANING EASINESS

1 IRIDIUM, IRON
2 CORTEN

PROTECT
ANTIBATTERICO - ANTIMICROBIAL



GARANZIA 20 ANNI
20 YEARS GUARANTEE

RESIDENZIALE | RESIDENTIAL



GARANZIA 10 ANNI
10 YEARS GUARANTEE

PUBBLICO | PUBLIC



Pavimento - Floor: **IRIDIUM** | ➔ 5,5 mm | 100x100 cm 39"x39" - Rivestimento - Wall: **PLATINUM RETT.** | ➔ 5,5 mm | 100x300 cm 39"x118"



IRIDIUM | ➔ 5,5 mm | 100x300 cm 39"x118"



OVER

THE URBAN SKIN

Pavimento-Rivestimento - Floor-Wall: OFFICE NATURALE | ± 3,5 mm | 100x100 cm 39"x39" - Tavolo - Table: ROAD NATURALE | ± 3,5 mm | 100x300 cm 39"x118"

OVER



OPENSACE

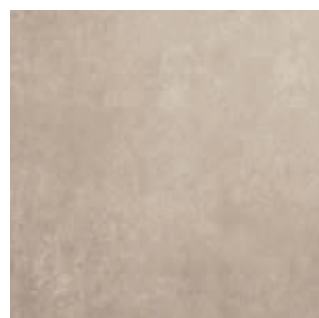

LOFT

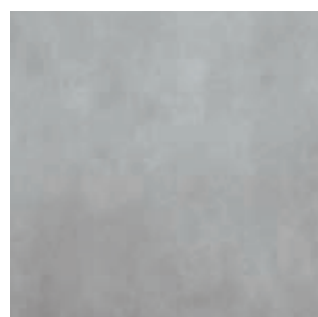

OFFICE

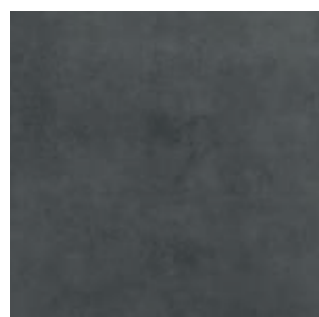

ROAD¹



NATURALE



SOFT¹



3,5 mm
RETTIFICATO
RECTIFIED



100x300 cm
39"x118"

NATURALE
SOFT



100x100 cm
39"x39"

NATURALE
SOFT



50x100 cm
19 1/2"x39"

NATURALE



50x50 cm
19 1/2"x19 1/2"

NATURALE



ROAD SOFT | 3,5 mm | 100x100 cm 39"x39"



**RESISTENZA ALLO
SCIVOLAMENTO**
SLIP RESISTANCE

R9 NATURALE



STONALIZZAZIONE
DESHADING

V2



**RESISTENZA ALL'ABRASIONE
PROFONDA**
DEEP ABRASION RESISTANCE

175 mm²
VALORE MEDIO - AVERAGE VALUE



VISIBILITÀ DELLE IMPRONTE
TREAD MARK VISIBILITY

A NATURALE
B SOFT (ROAD)
C SOFT (OPENSACE, OFFICE, LOFT)



FACILITÀ DI PULIZIA
CLEANING EASINESS

1 NATURALE
2 SOFT (ROAD)
3 SOFT (OPENSACE, OFFICE, LOFT)



GARANZIA 20 ANNI
20 YEARS GUARANTEE

RESIDENZIALE E PUBBLICO | RESIDENTIAL AND PUBLIC
NATURALE
RESIDENZIALE | RESIDENTIAL
SOFT (ROAD)



GARANZIA 10 ANNI
10 YEARS GUARANTEE

PUBBLICO | PUBLIC
SOFT (ROAD)
RESIDENZIALE | RESIDENTIAL
SOFT (OPENSACE, OFFICE, LOFT)

¹ROAD SOFT Adatto anche a commerciale leggero - Also suitable for light commercial



LOFT SOFT - ROAD SOFT | 3,5 mm | 100x100 cm 39"x39"



SOFT

Questa superficie dall'aspetto opaco e morbido, assai piacevole al tatto, si ottiene attraverso l'azione incisiva di spazzole diamantate di diversa grana.

This matt and soft surface, which is so pleasant to touch, is obtained using diamond brushes with different grain sizes.

Cette surface à l'aspect mat et doux, très agréable au toucher, est le résultat de l'action vigoureuse de meules diamantées de diverses granulométries.

Diese Matt und weich wirkende Oberfläche fühlt sich angenehm an und wird durch die Kerbwirkung von Diamantbürsten mit unterschiedlicher Körnung erzeugt.





OPENSACE LUX | 3.5 mm | 50x50 cm 24"x24"



Pavimento - Floor: OPENSACE LUX | 3.5 mm | 50x50 cm 20"x20" - Rivestimento - Wall: ROAD SOFT - OPENSACE SOFT | 3.5 mm | 100x100 cm 39"x39"



WONDERWALL

KERLITE ART

Pavimento - Floor: PIETRA D'ISEO CEPPPO RETT. | 6,5 mm | 100x100 cm 39"x39" - Rivestimento - Wall: FRAME | 3,5 mm | 100x300 cm 39"x118"

WONDERWALL

MATRIX*

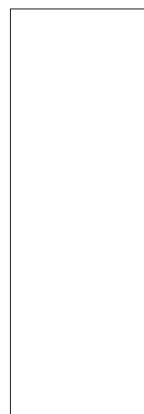

RITMI*



A1



B2



C3

JUNGLE



A



B



C

LOTUS



A



B



C

COLOR BALLET



A

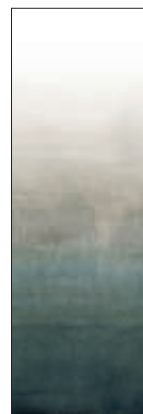

B



C

VENICE



A



B



C

DREAM

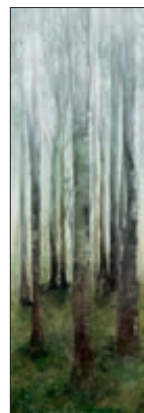

A

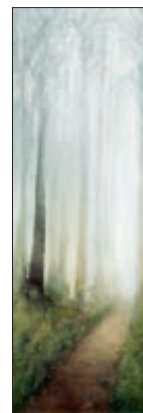

B



C

FREESTYLE

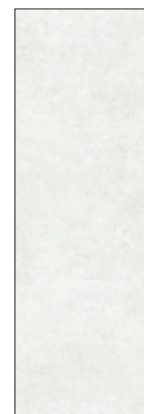

SKETCH



A-SX



A



B



B-DX

ZEN



A



B

SCRIPT

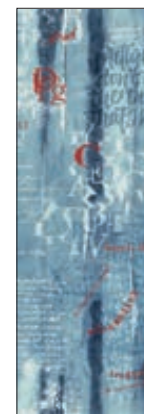

A



B

FRAME



A



B



C



D

kerlite
3plus

3,5 mm
RETTIFICATO
RECTIFIED



100x300 cm
39"x118"



100x100 cm *
39"x39"

*DISPONIBILE SOLO - AVAILABLE ONLY: **MATRIX**



PARETE E PAVIMENTO
WALL AND FLOOR



STONALIZZAZIONE
DESHADING

V1



RESISTENZA ALL'ABRASIONE
PROFONDA
DEEP ABRASION RESISTANCE

175 MM³ MATRIX, RITMI
VALORE MEDIO - AVERAGE VALUE



VISIBILITÀ DELLE IMPRONTE
TREAD MARK VISIBILITY

A MATRIX, RITMI



FACILITÀ DI PULIZIA
CLEANING EASINESS

1 MATRIX, RITMI

PROTECT
ANTIBATTERICO - ANTIMICROBIAL

MATRIX
RITMI



GARANZIA 20 ANNI
20 YEARS GUARANTEE

RESIDENZIALE E PUBBLICO | RESIDENTIAL AND PUBLIC
MATRIX, RITMI

PER ULTERIORI INFORMAZIONI SULLE DESTINAZIONI D'USO, SUI DATI TECNICI,
SULLE AVVERTENZE DI POSA E SULLA PULIZIA VEDERE P. 368-369
FOR FURTHER INFORMATION ON INTENDED USE, TECHNICAL SPECIFICATIONS,
INSTALLATION INSTRUCTIONS, AND CLEANING PLEASE SEE PAGE 368-369



MATRIX

Questa superficie si ispira alla classica texture della tela dei quadri d'autore con un effetto delicato e morbido al tatto. Essendo prodotto in primo fuoco, oltre che per la posa a parete, è idoneo alla posa a pavimento ed è garantito 20 anni. Inoltre è supporto ed elemento compositivo del tema decorativo Ritmi.

This surface is inspired by the gentle and soft texture of the canvases used by the great painters. This product is sintered and therefore it is suitable for installation on floors and walls and is guaranteed for 20 years. It is also the base and compositional element of the Ritmi decorative theme.

Cette surface est inspirée par la texture classique de la toile des tableaux d'auteur, avec un effet délicat et doux au toucher. Fabriquée en première cuisson, elle est idéale non seulement pour la pose murale, mais aussi pour la pose au sol, et est garantie 20 ans. Elle sert par ailleurs de support et d'élément de composition pour le thème décoratif Ritmi.

Diese Oberfläche inspiriert sich an der klassischen Struktur der Leinwand von Original-Bildern mit einem sanften und weichen Griff. Da die Oberfläche mit Erstbrennung produziert wird, ist sie sowohl für die Wandverkleidung als auch für den Bodenbelag geeignet und für 20 Jahre garantiert. Außerdem ist sie Träger und kompositorisches Element des dekorativen Themas Ritmi.



FREESTYLE

Questa superficie realizzata con una speciale resina spatolata a mano da esperti artigiani, è decorata a freddo con la nuova tecnologia digitale. Tutti i pezzi sono l'uno diverso dall'altro. Freestyle oltre ad essere motivo di rivestimento indipendente è il fondo su cui è realizzato il tema decorativo Sketch.

This surface, created using a special resin applied by hand by expert artisan craftsmen, is cold-decorated using a new digital technology. Each piece is unique. In addition to being a cladding material in and of itself, it is also the base for the decorative motif "Sketch".

Cette surface est réalisée avec une résine spéciale appliquée manuellement par des artisans experts et décorée à froid avec une technologie numérique innovatrice. Toutes les pièces diffèrent les unes des autres. Non seulement Freestyle est un revêtement à soi, mais il fait également office de fond pour le thème décoratif Sketch.

Diese Oberfläche wird aus einem speziellen Harz hergestellt, der von Hand von erfahrenen Handwerkern verspachtelt und im Kaltverfahren mit der neuen digitalen Technik dekoriert wird. Alle Teile sind untereinander verschieden. Freestyle ist nicht nur das unabhängige Motiv der Verkleidung sondern auch der Untergrund, auf dem das dekorative Thema Sketch realisiert wurde.



Pavimento - Floor: **VANITY, DARK BROWN GLOSSY RETT.** | 6.5 mm | 120x260 cm 48"x102" - Rivestimento - Wall: **JUNGLE** | 3.5 mm | 100x300 cm 39"x118"



Pavimento - Floor: **METAL IRIIDIUM** | 5,5 mm | 100x300 cm 39"x118"
Rivestimento - Wall: **DREAM** | 3,5 mm | 100x300 cm 39"x118"



Pavimento - Floor: **METAL IRIIDIUM** | 5,5 mm | 100x300 cm 39"x118" - Rivestimento - Wall: **DREAM** | 3,5 mm | 100x300 cm 39"x118"



Pavimento - Floor: VANITY, DARK BROWN TOUCH RETT. | ➔ 6,5 mm | 120x260 cm 48"x102" - Rivestimento - Wall: ZEN | ➔ 3,5 mm | 100x300 cm 39"x118"



Pavimento - Floor: FOREST, NOCE RETT. | 5,5 mm | 20x120 cm 8"x48" - 20x180 cm 8"x71" - Rivestimento - Wall: SCRIPT | 3,5 mm | 100x300 cm 39"x118"



RITMI | 3,5 mm | 100x300 cm 39"x118"



Pavimento - Floor: LIMESTONE OYSTER HONED RETT. | 14 mm | 60x120 cm - 24"x48" - Rivestimento - Wall: FREESTYLE - SKETCH | 3,5 mm | 100x300 cm 39"x118"



Pavimento - Floor: FOREST, CEMBRO RETT. | 14 mm | 20x120 cm 8"x48" - Rivestimento - Wall: LOTUS | 3.5 mm | 100x300 cm 39"x118"



X-BETON

CONCRETE SURFACE

DOT-70 NATURALE RETT. | ± 14 mm | 90x90 cm 36"x36"

X-BETON



DOT-30



DOT-50



DOT-70

14mm



RETTIFICATO
RECTIFIED

60x120 cm 24"x48"	90x90 cm 36"x36"	60x60 cm 24"x24"
NATURALE SATINATA	NATURALE SATINATA	NATURALE SATINATA

PEZZI SPECIALI
SPECIAL PIECES

60x7,2 cm 24"x2 7/8"	90x7,2 cm 36"x2 7/8"	120x34 cm 48"x13 3/8"	120x34 cm 48"x13 3/8"
NATURALE SATINATA Battiscopa con bisello Skirting	NATURALE SATINATA Battiscopa con bisello Skirting	NATURALE SATINATA Gradone Plus bordo Step tread Plus	SATINATA Gradone Plus angolo Destro/Sinistro Step tread Plus Right/Left corner

20mm



RETTIFICATO
RECTIFIED

90x90 cm 36"x36"	60x15 cm 24"x6"	60x30 cm 24"x13 3/8"
FIAMMATA	FIAMMATA Elemento Griglia Grill Component	FIAMMATA Gradone costa retta rigato con gocciolatoio Step tread straight edge with grooves and drip flap



DOT-70 NATURALE RETT. | ± 14 mm | 90x90 cm 36"x36"

**RESISTENZA ALLO
SCIVOLAMENTO
SLIP RESISTANCE**
R11 NATURALE, FIAMMATA
R10 SATINATA

**STONALIZZAZIONE
DESHADING**
V3

**RESISTENZA ALL'ABRASIONE
PROFONDA
DEEP ABRASION RESISTANCE**
143 mm³
VALORE MEDIO - AVERAGE VALUE

**VISIBILITÀ DELLE IMPRONTE
TREAD MARK VISIBILITY**
A SATINATA
B NATURALE, FIAMMATA

**FACILITÀ DI PULIZIA
CLEANING EASINESS**
2

PROTECT
ANTIBATTERICO - ANTIMICROBIAL

**GARANZIA 20 ANNI
20 YEARS GUARANTEE**
RESIDENZIALE E PUBBLICO
RESIDENTIAL AND PUBLIC



DOT-50 SATINATA RETT. | 14 mm | 90x90 cm 36"x36"



SATINATA

Le creste tipiche della struttura di questo cemento rullato vengono lucidate da una batteria di mole diamantate; successivamente l'intera superficie viene satinata da spazzole abrasive che ne spengono il riflesso complessivo. Il risultato è una piastrella sostanzialmente opaca ma morbida al tatto e sensibilmente più reattiva alla luce d'ambiente rispetto alla sua versione naturale.

The peculiar ridges of this rolled concrete structure are polished by a set of diamond grinding wheels. Then, the whole surface is finished with abrasive brushes that tone down the reflection of the product. The result is a tile with a matt tone and a beautiful soft surface, creating a final effect that is more reactive to the ambient light than the natural finish.

Les stries typiques de la structure de ce ciment roule sont polies avec une série de meules diamantées ; la surface entière est ensuite satinée avec des brosses abrasives qui en atténuent le reflet d'ensemble. Il en résulte un carreau essentiellement opaque mais doux au toucher, qui réagit bien plus à la lumière ambiante que sa version naturelle.

Die für den aufbau dieses walzbetons typische kammstruktur wird von einem satz diamant-schleifscheiben aufpoliert; anschliessend wird die gesamte oberfläche von schleifbürsten, die den gesamtglanz dämpfen, satiniert. Das ergebnis ist eine im wesentlichen matte aber geschmeidige fliese, die gegenüber ihrer natürlichen version viel sensibler auf die lichtumgebung reagiert.



DOT-30 SATINATA RETT. | 14 mm | 90x90 cm 36"x36"



DOT-50 NATURALE RETT. | \pm 14 mm | 90x90 cm 36x36 | 90x180 cm 36x36



LEGNI E TERRECOTTE

WOOD AND TERRACOTTA | BOIS ET TERRES CUITES | HÖLZER UND TERRAKOTTA



CADORE

THE WOOD PLANKS OF THE DOLOMITES

ALPE RETT. | 14 mm | 30x180 cm 12'x71"

CADORE



ALPE



BAITA

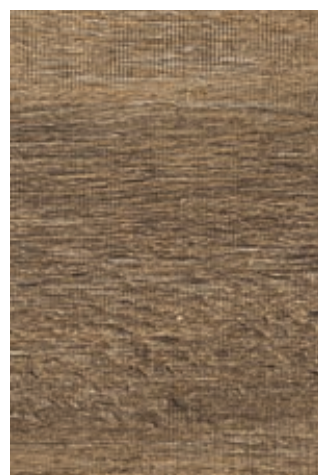

BOSCO



MALGA

14mm



RETTIFICATO
RECTIFIED



30x180 cm
12"x71"

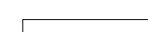

20x180 cm
8"x71"

PEZZI SPECIALI
SPECIAL PIECES

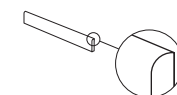

60x10 cm
24"x4"
Battiscopa a becco di civetta
Bullnose

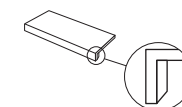

60x34 cm
24"x13³/₈"
Gradone Plus bordo
Step tread Plus

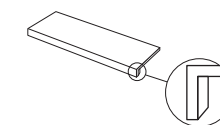

120x34 cm
48"x13³/₈"
Gradone Plus bordo
Step tread Plus

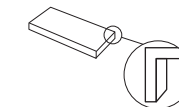

60x34 cm
24"x13³/₈"
Gradone Plus angolo Destro/Sinistro
Step tread Plus Right/Left corner

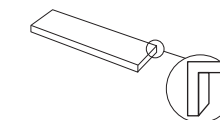

120x34 cm
48"x13³/₈"
Gradone Plus angolo Destro/Sinistro
Step tread Plus Right/Left corner

20mm



RETTIFICATO
RECTIFIED

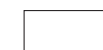

30x120 cm
12"x48"

DISPONIBILE IN - AVAILABLE IN: **BAITA, BOSCO, MALGA**



RESISTENZA ALLO
SCIVOLAMENTO
SLIP RESISTANCE

R11 20mm
R10 14mm



STONALIZZAZIONE
DESHADING

V4



RESISTENZA ALL'ABRASIONE
PROFONDA
DEEP ABRASION RESISTANCE

143 mm³
VALORE MEDIO - AVERAGE VALUE



VISIBILITÀ DELLE IMPRONTE
TREAD MARK VISIBILITY

A 14mm (BAITA, BOSCO, MALGA)
B 14mm (ALPE), 20mm



FACILITÀ DI PULIZIA
CLEANING EASINESS

1 14mm
2 20mm

PROTECT
ANTIBATTERICO - ANTIMICROBIAL

14mm



GARANZIA 20 ANNI
20 YEARS GUARANTEE

RESIDENZIALE E PUBBLICO
RESIDENTIAL AND PUBLIC



BOSCO RETT. | 20 mm | 30x120 cm 12"x48"



CADORE

Le doghe di Cadore uniscono alla rugosità e alle differenze di rilievo tra le fibre tipiche delle assi di legno grezzo le tracce trasversali dovute al taglio effettuato a sega. L'effetto finale, ottenuto anche grazie alla significativa stonizzazione del fondo e alla marcata texture superficiale, è di forte rusticità e naturalità. Un legno ceramico progettato per l'outdoor, autentico nell'aspetto e dalle elevate prestazioni tecniche.

The Cadore slabs combine the roughness and surface differences between the fibres typical of untreated wooden planks and the transversal lines caused by saw cutting. The final effect, also achieved by intensive shading of the base and accentuated surface texture, is a highly rustic and natural finish. A ceramic wood designed for outdoors, authentic in appearance with excellent technical performances.

Les lattes de Cadore ajoutent à la rugosité et aux différences de relief entre les fibres typiques des planches de bois brut les traces transversales dues à la coupe effectuée à la scie. Obtenu également grâce au dégradé significatif du fond et à la texture superficielle marquée, l'effet final est rustique et naturel. Un bois céramique conçu pour l'extérieur, à l'aspect authentique et aux prestations techniques élevées.

Die Fliesen Cadore vereinen die Rauheit und Hauptunterschiede der typischen Maserung der groben Holzplanken mit den schräg verlaufenden Spuren durch den Sägeschnitt. Die erhebliche Farbabweichung der Unterseite und die ausgeprägte Oberflächenstruktur verleihen der Platte einen rustikalen und natürlichen Endeffekt. Ein Keramik-Holz für den Außenbereich, authentisch in der Optik und mit hohen technischen Leistungen.



MALGA RETT. | 14 mm | 30x180 cm 12"x71" - 20x180 cm 8"x71"



BOSCO RETT. | 14 mm | 20x180 cm 8'x71"



BOSCO RETT. | 14 mm | 20x180 cm 8'x71"





CASALI
RECLAIMED TERRACOTTA

COLFIORITO | 14 mm | 30x30 cm 12" x 12"

CASALI



COLFIORITO



CÁ DEL BOSCO

14mm



RETTIFICATO
RECTIFIED



30x30 cm
12"x12"



15x30 cm
6"x12"

PEZZI SPECIALI
SPECIAL PIECES

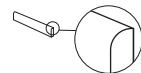

30x7,2 cm
12"x2 7/8"
Battiscopa a becco di civetta
Bullnose



30x33 cm
12"x13"
Gradino Toro bordo
Thin Step tread



33x33 cm
13"x13"
Gradino Toro angolare
Thin Corner Step tread



COLFIORITO | 14 mm | 15x30 cm 6"x12"



**RESISTENZA ALLO
SCIVOLAMENTO**
SLIP RESISTANCE

R9



STONALIZZAZIONE
DESHADING

V4



**RESISTENZA ALL'USURA
DA CALPESTIO**
RESISTANCE TO TRAMPLING WEAR

PEI 5



VISIBILITÀ DELLE IMPRONTE
TREAD MARK VISIBILITY

A



FACILITÀ DI PULIZIA
CLEANING EASINESS

1



GARANZIA 20 ANNI
20 YEARS GUARANTEE

RESIDENZIALE E PUBBLICO
RESIDENTIAL AND PUBLIC





FOREST

ESSENCE OF WOOD

ROVERE | 5.5 mm | 20x180 cm 8"x71" - 20x120 cm 8"x48"

FOREST



ACERO



ROVERE



NOCE



CEMBRO

kerlite
5plus



5,5 mm
RETTIFICATO
RECTIFIED



100x300 cm
39"x118"



33x300 cm
13"x118"



20x180 cm
8"x71"



20x120 cm
8"x48"

ROVERE | 5,5 mm | 20x180 cm 8"x71" - 20x120 cm 8"x48"



RESISTENZA ALLO
SCIVOLAMENTO
SLIP RESISTANCE

R10

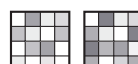

STONALIZZAZIONE
DESHADING

V3
ACERO
NOCE

V4
CEMBRO
ROVERE



RESISTENZA ALL'ABRASIONE
PROFONDA
DEEP ABRASION RESISTANCE

175 mm³
VALORE MEDIO - AVERAGE VALUE



VISIBILITÀ DELLE IMPRONTE
TREAD MARK VISIBILITY

A NOCE, CEMBRO
B ACERO, ROVERE



FACILITÀ DI PULIZIA
CLEANING EASINESS

1 NOCE, CEMBRO
2 ACERO, ROVERE

PROTECT
ANTIBATTERICO - ANTIMICROBIAL



GARANZIA 20 ANNI
20 YEARS GUARANTEE

RESIDENZIALE E PUBBLICO
RESIDENTIAL AND PUBLIC



COOKING



CEMBRO | 5,5 mm | 20x120 cm 8"x48" - 20x180 cm 8"x71"



CEMBRO | 5,5 mm | 20x120 cm 8"x48" - 20x180 cm 8"x71"



ACERO | 5,5 mm | 20x120 cm 8"x48" - 20x180 cm 8"x71"



NOCE | 5,5 mm | 33x300 cm 13"x118"



NOCE | 5,5 mm | 33x300 cm 13"x118"



WOODLAND

THE ELEGANCE OF NATURE

ARDEN WILD | 6.5 mm | 30X240 cm - 20X120 cm | 9° x 9° | 30X120 cm | 5° x 48°

WOODLAND



ARDEN WILD



WALDEN WILD



GROVE WILD



ATLANTIC SOFT



BOREAL SOFT



TROPICAL SOFT



TEAK SOFT



EBONY SOFT

kerlite
6plus

SOFT   

WILD   

6,5 mm
RETTIFICATO
RECTIFIED



30x240 cm
12"x96"

20x120 cm
8"x48"



GROVE WILD | 6,5 mm | 30x240 cm 12"x96"

 **RESISTENZA ALLO SCIVOLAMENTO**
SLIP RESISTANCE
R9 SOFT
R10 WILD

  **STONALIZZAZIONE**
DESHADING
V3 ACERO NOCE
V4 CEMBRO ROVERE

 **RESISTENZA ALL'ABRASIONE PROFONDA**
DEEP ABRASION RESISTANCE
175 mm³
VALORE MEDIO - AVERAGE VALUE

 **VISIBILITÀ DELLE IMPRONTE**
TREAD MARK VISIBILITY
A

 **FACILITÀ DI PULIZIA**
CLEANING EASINESS
1

PROTECT
ANTIBATTERICO - ANTIMICROBIAL

 **GARANZIA 20 ANNI**
20 YEARS GUARANTEE
RESIDENZIALE E PUBBLICO
RESIDENTIAL AND PUBLIC



Pavimento_floor: ARDEN WILD | 6,5 mm | 30x240 cm 12"x96"



WALDEN WILD | 6,5 mm | 30x240 cm 12"x96"



BOREAL SOFT | 6,5 mm | 30x240 cm 12"x96"



TROPICAL SOFT | 6.5 mm | 20x120 cm 8"x48"



TROPICAL SOFT | 6,5 mm | 20x120 cm 8"x48"



TROPICAL SOFT | 6,5 mm | 20x120 cm 8"x48"



Pavimento-floor: ATLANTIC SOFT | $\frac{1}{2}$ 6.5 mm | 30x240 cm 12"x96" - 20x120 cm 8"x48"

Rivestimento-wall: METAL CORTEN | $\frac{1}{2}$ 5.5 mm | 100x300 cm 39"x120" Desk: METAL CORTEN



EBONY SOFT | 6,5 mm | 30x240 cm 12"x96"



EBONY SOFT | 6,5 mm | 30x240 cm 12"x96"



INDICE
INDEX

- 304 GREEN MISSION**
GREEN MISSION
- 312 KERLITE**
DESTINAZIONI D'USO
INTENDED USES
- 314 CARATTERISTICHE TECNICHE**
TECHNICAL FEATURES
- 320 CARATTERISTICHE TECNICHE 14 - 20mm**
TECHNICAL FEATURES
- 324 CARATTERISTICHE TECNICHE KERLITE**
TECHNICAL FEATURES
- 328 FORMATI**
SIZES
- 332 TABELLE CALIBRI**
SIZE TABLES
- 333 SUGGERIMENTI PER LA POSA**
LAYING SUGGESTIONS
- 334 GRADINO PLUS**
STEP TREAD PLUS
- 335 GRADONE COSTA RETTA RIGATO CON GOCCIOLATOIO**
STEP TREAD STRAIGHT EDGE WITH GROOVES AND DRIP FLAP
- 336 GARANZIA COTTO D'ESTE**
COTTO D'ESTE GUARANTEE
- 338 PULIZIA E TRATTAMENTI**
CARE AND TREATMENT
- 344 WONDERWALL**
INFORMAZIONI TECNICHE
TECHNICAL INFORMATION
- 346 CERTIFICAZIONI**
CERTIFICATIONS
- 354 CONFEZIONI**
PACKAGING
- 356 DESTINAZIONI D'USO**
INTENDED USES
- 358 CONDIZIONI GENERALI DI VENDITA**
GENERAL TERMS AND CONDITIONS OF SALES



GREEN MISSION

SANO SICURO ECOSOSTENIBILE

HEALTHY SAFE ECOFRIENDLY | SAIN SÛR ÉCO-DURABLE | GESUND SICHER UMWELTFREUNDLICH

ABITARE UN AMBIENTE SANO LIVING IN A HEALTHY ENVIRONMENT | HABITER DANS UN ENVIRONNEMENT SAIN | IN EINER GESUNDEN UMGEBUNG WOHNEN



ANTIBATTERICO

ANTIMICROBIAL | ANTIBACTÉRIEN | ANTIBAKTERIELL

Azione potente, elimina fino al 99,9% di batteri. La tecnologia adottata nei prodotti PROTECT è basata sugli ioni d'argento blocca il metabolismo dei batteri, eliminandoli e impedendone la proliferazione. Protezione continua 24 ore su 24. Diversamente da altre tecnologie, come quelle basate sull'utilizzo del Biossido di Titanio, lo scudo protettivo è sempre attivo, giorno e notte, con o senza luce solare e non necessita di raggi UV per l'attivazione.

Powerful action, kills up to 99.9% of bacteria. The technology used in PROTECT products, based on silver ions blocks the metabolism of bacteria, eliminating them and preventing their proliferation. Continuous protection 24 hours a day. Unlike other technologies, such as those based on the use of Titanium Dioxide, the protective shield is always active, day and night, with or without sunlight and it does not need UV rays for activation.

Action puissante, élimine jusqu'à 99,9% de bactéries. La technologie, adoptée dans les produits PROTECT et basée sur les ions d'argent, bloque le métabolisme des bactéries, en les éliminant et en empêchant leur prolifération. Protection continue 24 heures sur 24. Différente des autres technologies, comme celles basées sur l'utilisation du Bioxyde de Titane, le bouclier de protection est toujours actif, jour et nuit, avec ou sans lumière du soleil et n'a pas besoin de rayons UV pour l'activation.

Leistungsstarke Wirkung. Eliminiert bis zu 99,9% Bakterien. Die bei den PROTECT Produkten verwendete Technologie basiert auf Silberionen, die den Stoffwechsel der Bakterien blockieren, sie eliminieren und ihre Verbreitung verhindern. Dauerschutz rund um die Uhr. Im Gegensatz zu anderen Technologien, wie zum Beispiel denen, die auf der Verwendung von Titandioxid basieren, ist das Schutzschild immer aktiv, Tag und Nacht, mit oder ohne Sonnenlicht; es bedarf keines UV-Lichts für die Aktivierung.



FACILE PULIZIA QUOTIDIANA

EASY DAY-TO-DAY CLEANING | NETTOYAGE QUOTIDIEN FACILE | EINFACHE TÄGLICHE REINIGUNG

Le nostre superfici ceramiche si puliscono con l'uso di sola acqua calda e panni in microfibra. Di tanto in tanto (ogni 10-20 giorni) si consiglia di utilizzare detergenti neutri molto diluiti e di risciacquare sempre con acqua.

Our ceramic surfaces can be cleaned by simply using hot water and microfibre cloths. Occasionally (every 10-20 days) we recommend using very diluted neutral detergents and always rinsing with water.

Nos surfaces en céramique peuvent être nettoyées en utilisant uniquement de l'eau chaude et des chiffons en microfibre. De temps en temps (tous les 10-20 jours), il est conseillé d'employer des détergents neutres très dilués et de toujours rincer à l'eau.

Unsere keramischen Oberflächen werden nur mit heißem Wasser und Tüchern aus Mikrofasern gereinigt. Ab und zu (alle 10 - 20 Tage) wird der Einsatz eines stark verdünnten neutralen Reinigungsmittels und das Nachspülen mit klarem Wasser empfohlen.



NESSUNA SOSTANZA NOCIVA

NO HARMFUL SUBSTANCES | AUCUNE SUBSTANCE NOCIVE | KEINE SCHÄDLICHE SUBSTANZ

La ceramica è un materiale inerte che, per sua natura, non dà luogo a nessuna reazione chimica. I prodotti Cotto d'Este pertanto (sia in gres porcellanato 14 mm che in KERLITE) non rilasciano nessuna sostanza organica volatile (VOC).

Ceramic is an inert material which, by its nature, does not give rise to any chemical reaction. Therefore Cotto d'Este products (both 14 mm porcelain stoneware and KERLITE) do not release any volatile organic compounds (VOC).

La céramique est un matériau inerte qui, par sa nature même, ne donne lieu à aucune réaction chimique. Par conséquent, les produits Cotto d'Este (que ce soit en grès cérame 14 mm ou en KERLITE) ne libèrent aucun composé organique volatil (COV).

Die Keramik ist von Natur aus ein inertes Material, das zu keiner chemischen Reaktion führt. Daher setzen die Produkte Cotto d'Este (sowohl das Feinsteinzeug 14 mm als auch KERLITE) keine flüchtigen organischen Substanzen (VOC) frei.



MASSIMA IGIENE

MAXIMUM HYGIENE | HYGIÈNE MAXIMALE | HÖCHSTE HYGIENE

Poiché il nostro gres porcellanato cuoce a una temperatura superiore a 1200°C la sua superficie è, al pari del vetro, inassorbente, priva di pori e di umidità. Pertanto non trattiene lo sporco e la polvere e non consente agli acari di annidarsi. Per questo la ceramica trova larghissimo impiego in luoghi che necessitano della massima igiene, come ambienti sanitari, laboratori, cucine, ristoranti, asili, scuole, case di riposo, ecc.

Since our porcelain stoneware is fired at temperatures above 1200°C, the surface, like glass, is non-absorbing, non-porous and free of moisture. As a result it does not retain dirt and dust and does not allow mites to nest. For this reason, ceramics are widely used in places that require maximum hygiene, such as healthcare environments, laboratories, kitchens, restaurants, nurseries, schools, nursing homes, etc.

Notre grès cérame cuit à une température supérieure à 1200°C; sa surface est donc, telle le verre, non absorbante et exempte de pores et d'humidité. Elle ne retient donc pas la saleté et la poussière et empêche les acariens de s'y installer. C'est pourquoi la céramique est largement utilisée dans les endroits qui exigent une hygiène totale, comme les milieux médicaux, les laboratoires, les cuisines, les restaurants, les crèches, les écoles, les maisons de repos, etc.

Da unser Feinsteinzeug bei einer Temperatur von mehr als 1200°C gebrannt wird, ist seine Oberfläche, genauso wie Glas, nicht absorbierend, porenfrei und trocken. Deshalb hält sie keinen Schmutz und Staub fest und verhindert das Einnisten von Milben. Aus diesem Grund findet die Keramik große Anwendung an Orten, die ein Maximum an Hygiene erfordern, wie Umgebungen im Gesundheitswesen, Labors, Küchen, Restaurants, Kindergärten, Schulen, Pflegeheime usw.



UN GRANDE VANTAGGIO

A GREAT ADVANTAGE | UN INCONTESTABLE AVANTAGE | EIN GROSSER VORTEIL

Per tutti questi aspetti, l'utilizzo di gres porcellanato Cotto d'Este per il rivestimento delle superfici interne ed esterne comporta numerosi, importanti vantaggi per la vostra salute rispetto agli altri prodotti ceramici, al marmo, alla pietra naturale, alla moquette e al linoleum.

Due to all these aspects, the use of Cotto d'Este porcelain stoneware to cover internal and external surfaces has numerous benefits for your health when compared to other ceramic products, marble, natural stone, carpets and linoleum.

Par conséquent, utiliser le grès cérame Cotto d'Este pour le revêtement des surfaces intérieures et extérieures comporte de nombreux et importants avantages pour votre santé par rapport à d'autres produits en céramique, au marbre, à la pierre naturelle, à la moquette et au linoléum.

Aus all diesen Gründen beinhaltet der Einsatz des Feinsteinzeugs Cotto d'Este für die Verkleidung von Innen- und Außenflächen zahlreiche wichtige Vorteile für Euer Gesundheit im Vergleich zu anderen Keramikprodukten, Marmor, Naturstein, Teppichboden und Linoleum.

SCEGLI CHI RISPETTA IL PIANETA CHOSEN BY THOSE WHO RESPECT THE PLANET | CHOISISSEZ CEUX QUI RESPECTENT LA PLANÈTE ENTSCHEIDE DICH FÜR DIEJENIGEN, DIE DEN PLANETEN RESPEKTIEREN



IL MATERIALE DA RIVESTIMENTO PIÙ DUREVOLE AL MONDO

THE MOST DURABLE COATING MATERIAL IN THE WORLD | LE MATÉRIAU DE REVÊTEMENT LE PLUS PÉRENNE AU MONDE | DIE WELTWEITHALTBARSTE MATERIALBESCHICHTUNG

Il gres porcellanato e il gres laminato Cotto d'Este sono garantiti fino a 20 anni ma sono materiali molto più longevi: vivono quanto l'edificio in cui sono installati, più di qualsiasi altro materiale da rivestimento. Al termine del suo ciclo di vita, il gres porcellanato può inoltre essere interamente riciclato come sottofondo di opere edili e stradali, o facilmente smaltito come un qualunque altro materiale inerte.

Cotto d'Este porcelain tiles and laminated porcelain stoneware are guaranteed up to 20 years but they actually last much longer. Their life cycle is the same as that of the buildings in which they are installed and longer than that of any other coating material. At the end of their life cycle, porcelain tiles can also be fully recycled as the foundation for roads and buildings, or easily disposed of like any other inert material.

Le grès cérame et le grès laminé Cotto d'Este sont garantis jusqu'à 20 ans mais ces matériaux durent beaucoup plus longtemps: autant que le bâtiment où ils sont installés et plus que tout autre matériau de revêtement. À la fin de son cycle de vie, le grès cérame peut par ailleurs être entièrement recyclé et servir de sous-couche à des travaux de construction ou de voirie, ou encore être facilement éliminé comme tout autre matériau inerte.

Das Feinsteinzeug und das laminierte Feinsteinzeug Cotto d'Este sind bis zu 20 Jahre garantiert, sind aber sehr viel langlebigere Materialien: sie halten solange wie das Gebäude in dem sie verlegt sind, mehr als jedes andere Beschichtungsmaterial. Am Ende ihres Lebenszyklus kann das Feinsteinzeug auch vollständig als Untergrund für Bauoder Straßenarbeiten wieder verwertet oder ganz einfach wie jedes andere Inertmaterial entsorgt werden.



FONTI ENERGETICHE RINNOVABILI

RENEWABLE ENERGY SOURCES | SOURCES D'ÉNERGIES RENOUVELABLES | ERNEUERBARE ENERGIEN

Impianti fotovoltaici installati sulle coperture dei nostri impianti permettono di ridurre il fabbisogno di energia elettrica degli stabilimenti produttivi.

Photovoltaic systems installed on the roofs of our production plants enable us to reduce electrical energy consumption in our factories.

Les systèmes photovoltaïques disposés sur les toitures de nos installations permettent de réduire le besoin en énergie électrique des usines de production.

Photovoltaik-Systeme, die auf den Dächern unserer Produktionsanlagen installiert sind, erlauben die Reduzierung des Strombedarfs unserer Werkstätten.



SALVAGUARDIA DELLE RISORSE IDRICHE

OPTIMIZING WATER RESOURCES | SAUVEGARDE DES RESSOURCES HYDRIQUES | SCHUTZ DER WASSERRESSOURCEN

I nostri impianti produttivi riutilizzano il 100% dell'acqua di processo. Questo porta a ridurre il consumo di risorse idriche naturali dei cicli produttivi fino all'80%.

Our manufacturing facilities reuse 100% of the water used in the production process. This leads to a reduction in the consumption of natural water resources during the production cycles of up to 80%.

Nos installations de production réutilisent 100 % des eaux de processus. Il s'ensuit une réduction de la consommation en ressources hydriques naturelles des cycles de production allant jusqu'à 80 %.

Unsere Produktionsanlagen verwenden 100% des Prozesswassers erneut. Dies führt zu einem reduzierten Verbrauch der natürlichen Wasserressourcen der Produktionszyklen von bis zu 80%.



CONTENUTO DI MATERIALE RICICLATO

MADE WITH RECYCLED MATERIAL | CONTENU EN MATÉRIAU RECYCLÉ | RECYCLINGMATERIAL

Confermando sempre gli elevatissimi standard estetici e di qualità Cotto d'Este, salvaguardiamo le risorse naturali con prodotti virtuosi che contengono almeno il 40% di materie prime di riciclo.

While constantly ensuring the high aesthetic standards and quality of Cotto d'Este, we safeguard natural resources by manufacturing eco-friendly products containing at least 40% recycled raw materials.

Cotto d'Este confirme toujours ses hauts standards d'esthétique et de qualité en sauvegardant les ressources naturelles avec des produits vertueux qui contiennent au moins 40 % de matières premières de recyclage.

Mit der Bestätigung der sehr hohen ästhetischen Standards und der Qualität von Cotto d'Este schützen wir die natürlichen Ressourcen mit tugendhaften Produkten, die mindestens zu 40% aus recycelten Rohstoffen bestehen.



MINORI CONSUMI DI ENERGIA E MINORI EMISSIONI DI CO₂

REDUCED ENERGY CONSUMPTION AND REDUCED EMISSIONS OF CO₂ | CONSOMMATIONS D'ÉNERGIE ET ÉMISSIONS DE CO₂ PLUS FAIBLES | WENIGER ENERGIEVERBRAUCH UND GERINGERE CO₂-ABGABEN

In rapporto alla maggior parte degli altri materiali da rivestimento (parquet, pietra naturale, sughero), il gres porcellanato consuma meno energia* per la sua produzione. Per questo, grazie anche ad impianti moderni e alla sua elevatissima durata nel tempo, il nostro gres porcellanato emette meno CO₂ per mq di prodotto.

* Valori ottenuti dall'elaborazione dei dati EMAS 2013 per KERLITE e del database ICE e ECO-BAU per il gres porcellanato spessore 10 mm, che comprendono i valori di consumo energetico per l'estrazione delle materie prime (fonte: EPD di prodotti di pari spessore).

Compared to most other finishing materials (parquet flooring, natural stone, cork), the production of porcelain tiles consumes less energy*. For this reason together with modern production facilities and the very high durability of the product itself, our porcelain stoneware emits less CO₂ per square metre of product.

* Values obtained from EMAS 2013 data for KERLITE and the ICE and ECO-BAU database for 10 mm thick porcelain stoneware, including the energy consumption values for the extraction of raw materials (source: EPD of products of the same thickness).

Comparée à celle de la plupart des autres matériaux de revêtement (parquet, pierre naturelle, liège), la production de grès cérame consomme moins d'énergie*. C'est pourquoi notre grès cérame émet moins de CO₂ par m² de produit, grâce aussi à des installations modernes et à sa très longue durée de vie.

* Valeurs obtenues à partir de l'élaboration des données EMAS 2013 pour KERLITE et de la base de données ICE et ECO-BAU pour le grès cérame de 10 mm d'épaisseur, qui comprennent les valeurs de consommation énergétique pour l'extraction des matières premières (source: EPD de produits d'épaisseur égale).

Im Vergleich zu den meisten anderen Bodenbelägen (Parkett, Naturstein, Kork) verbraucht das Feinsteinzeug weniger Energie* bei seiner Herstellung. Aus diesem Grund und dank auch der modernen Anlagen und seiner hohen Lebensdauer auf Zeit, ist die CO₂-Abgabe pro qm des Produkts sehr viel geringer.

* Werte aus der Datenverarbeitung EMAS 2013 für KERLITE und der Datenbank ICE und ECO-BAU für Feinsteinzeug in 10 mm Stärke, einschließlich der Energieverbrauchswerte für die Gewinnung von Rohstoffen (Quelle: EPD von Produkten der gleichen Stärke).

ENERGIA INCORPORATA / EMBODIED ENERGY (MJ/mq)

(PROCESSO PRODUTTIVO COMPLETO / THE COMPLETE PRODUCTION CYCLE)

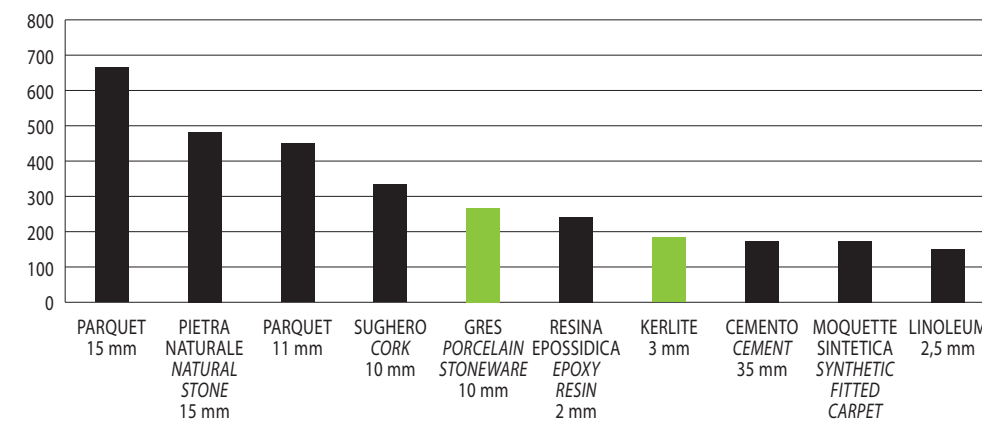

fonte / source: KBOB / eco-bau / IPB 2009/1:2014 (ottobre / october 2014)

Il gres porcellanato e il gres laminato KERLITE Cotto d'Este sono materiali da rivestimento molto più longevi di tutti gli altri. Per questo, anche da un punto di vista energetico, sul lungo periodo risultano globalmente più performanti anche di materiali che incorporano meno energia, come ad esempio la moquette. Se infatti ipotizziamo che la moquette vada sostituita ogni venti anni, dopo sessanta anni avremo consumato tre volte l'energia necessaria a produrla; al contrario, dopo lo stesso periodo di tempo il gres porcellanato e il gres laminato KERLITE saranno ancora in ottimo stato.

Cotto d'Este porcelain stoneware and Kerlite laminated porcelain are the most long-lasting tiling and cladding materials available. For this reason, even from an energy consumption point of view, in the long term they are more efficient than products for which less energy is required initially, such as fitted carpets. Assuming that fitted carpets must be replaced every 20 years, after 60 years we will have consumed three times the energy needed to cover the surface area. On the other hand, at the end of the same period, porcelain tiles and Kerlite laminated porcelain will still be in excellent shape.

Le grès cérame et le grès laminé KERLITE Cotto d'Este sont des matériaux de revêtement beaucoup plus durables que tous les autres. C'est pourquoi, d'un point de vue énergétique aussi, ils sont globalement plus performants que d'autres matériaux qui requièrent moins d'énergie, comme la moquette par exemple. En effet, si l'on suppose que la moquette doit être remplacée tous les vingt ans, on aura consommé après soixante ans trois fois l'énergie nécessaire à sa production; au bout de la même période en revanche, le grès cérame et le grès laminé KERLITE seront encore en excellent état.

Das Feinsteinzeug und das laminierte Feinsteinzeug KERLITE von Cotto d'Este sind Verkleidungsmaterialien mit einer wesentlich längeren Lebensdauer als alle andere. Deshalb und auch aus Sicht der Energie sind sie langfristig insgesamt leistungstärker als Materialien, die weniger Energie integrieren, wie beispielsweise der Teppichboden. Wenn wir in der Tat davon ausgehen, dass der Teppichboden alle zwanzig Jahre ersetzt werden muss, hätten wir nach sechzig Jahren das Dreifache der erforderlichen Energie für die Produktion verbraucht; im Gegensatz dazu ist das Feinsteinzeug und das laminierte Feinsteinzeug KERLITE nach dem selben Zeitraum immer noch in sehr gutem Zustand.

LA CARTA DI IDENTITÀ AMBIENTALE DI KERLITE

KERLITE: THE ENVIRONMENTAL IDENTITY CARD | LA CARTE D'IDENTITÉ ENVIRONNEMENTALE DE KERLITE | DER UMWELTPERSONALAUSWEIS VON KERLITE



MENO MATERIE PRIME

LESS RAW MATERIALS | MOINS DE MATIÈRES PREMIÈRES | WENIGER ROHSTOFFE

KERLITE è sottile e leggero: 1 mq (spessore 3,5 mm) pesa solo 7,8 kg. Questo significa che per produrlo occorre circa un terzo delle materie prime necessarie per ottenere una identica quantità di ceramica tradizionale di spessore 10 mm.

KERLITE is thin and light: 1 m² (3.5 mm thick) weighs only 7.8 kg. This means that to produce it only about one third of the raw materials are needed that would normally be required to obtain an identical amount of traditional 10 mm-thick ceramic tiles.

KERLITE est fin et léger : 1 m² (épaisseur 3,5 mm) ne pèse que 7,8 kg. Cela veut dire que pour le produire, il faut environ un tiers des matières premières nécessaires à l'obtention d'une quantité identique de céramique traditionnelle de 10 mm d'épaisseur.

KERLITE ist dünn und leicht: 1 qm (3,5 mm dick) wiegt nur 7,8 kg. Dies bedeutet, dass man zur Produktion ungefähr ein Drittel der Rohstoffe braucht, um die gleiche Menge der traditionellen Keramik mit einer Dicke von 10 mm zu erhalten.



RINNOVARE SENZA DEMOLIRE

RENOVATE WITHOUT DEMOLISHING | RÉNOVER SANS DÉMOLIR | ERNEUERN OHNE ABZUREISSEN

Il ridotto spessore di KERLITE ha un altro grande vantaggio: permette la posa in sovrapposizione ai vecchi pavimenti e rivestimenti, facendovi risparmiare i costi e i disagi di una demolizione. Un gran beneficio anche per l'ambiente, se si considera che oggi in Europa quasi un terzo dei rifiuti prodotti deriva dalla costruzione e demolizione di edifici*. Nessuna demolizione, nessun rifiuto a carico del pianeta.

The reduced thickness of KERLITE has another great advantage: it means it can be installed straight over existing floors and walls, saving you the cost and hassle of a demolition. A great benefit for the environment, when you consider that in Europe today almost one third of the waste comes from the construction and demolition of buildings.* No demolition means no waste for the planet.

L'épaisseur réduite de KERLITE comporte un autre avantage de taille : il peut être superposé sur de vieux revêtements de sols et de murs, ce qui permet d'éviter les coûts et les inconvénients d'une démolition. Cela représente également un grand avantage pour l'environnement, si l'on considère qu'aujourd'hui en Europe, presque un tiers des déchets produits provient de la construction et de la démolition de bâtiments*. Aucune démolition, aucun déchet pour notre planète.

Die reduzierte Dicke von KERLITE hat einen weiteren großen Vorteil: sie ermöglicht das Verlegen auf bereits bestehenden Böden und Verkleidungen und spart damit Kosten und Aufwand für den Abriss. Ein großer Vorteil auch für die Umwelt, wenn man bedenkt, dass heute in Europa fast ein Drittel der Abfälle aus dem Bau und Abriss von Gebäuden* stammt. Kein Abriss, kein Abfall zu Lasten des Planeten.

* Dati della Commissione Europea: http://ec.europa.eu/environment/waste/construction_demolition.htm

* Data from the European Commission: http://ec.europa.eu/environment/waste/construction_demolition.htm

* Données de la Commission européenne: http://ec.europa.eu/environment/waste/construction_demolition.htm

* Daten der Europäischen Kommission: http://ec.europa.eu/environment/waste/construction_demolition.htm



MENO ACQUA

LESS WATER | MOINS D'EAU | WENIGER WASSER

Per produrre 1 mq di KERLITE occorrono 65 litri di acqua*: quasi 6 volte meno di quella che sta a monte di un gres porcellanato di spessore 10 mm. Una tazzina di caffè o un calice di vino hanno un fabbisogno di acqua doppio; un chilo di carne di manzo ne richiede 240 volte di più.

To manufacture 1 m² of KERLITE, 65 litres of water are needed.** almost 6 times less than that needed for ceramic tiles with a thickness of 10 mm. To produce a cup of coffee or a glass of wine double the amount of water is needed and a kilogram of beef requires 240 times more water.

Pour produire 1 m² de KERLITE, 65 litres d'eau sont nécessaires*: presque 6 fois moins que celle nécessaire à un gres cérame de 10 mm d'épaisseur. Pour une tasse de café ou un verre de vin, il faut deux fois plus d'eau ; pour un kilo de viande de boeuf, il en faut 240 fois plus.

Für die Produktion von 1 qm KERLITE braucht man 65 Liter Wasser **: fast 6-mal weniger als die Menge, die man für die Produktion von Keramikfliesen mit einer Dicke von 10 mm benötigt. Eine Tasse Kaff ee oder ein Glas Wein bedürfen doppelt so viel Wasser; ein Kilo Rindfleisch verlangt 240 mal mehr Wasser.

** Valori ottenuti dall'elaborazione dei dati EMAS 2013 degli stabilimenti Panariagroup di Fiorano Modenese e Finale Emilia. Includono l'uso di acqua depurata e acqua da pozzo utilizzata in stabilimento.

** Values obtained from EMAS 2013 data from Panariagroup installations in Fiorano Modenese and Finale Emilia. They include the use of purified water and well water used in the factory.

** Valeurs obtenues à partir de l'élaboration des données EMAS 2013 pour les usines Panariagroup de Fiorano Modenese et Finale Emilia. Elles comprennent l'eau épurée et l'eau de puits utilisées à l'usine.

** Werte aus der Datenverarbeitung EMAS 2013 der Betriebe Panariagroup Fiorano Modenese und Finale Emilia. Sie umfassen die Verwendung von gereinigtem Wasser und in der Fabrik verwendetem Wasser.



UN MATERIALE DESTINATO A DURARE

A MATERIAL DESIGNED TO LAST | UN MATÉRIAU FAIT POUR DURER | EIN MATERIAL FÜR LANGE LEBENSDAUER

In un'ottica di ecosostenibilità quello della durata è un criterio fondamentale da rispettare. Il gres laminato Cotto d'Este, garantito fino a 20 anni, è un materiale da rivestimento estremamente longevo: il suo ciclo di vita è pari a quello dell'edificio in cui è installato, più di qualsiasi altro materiale da rivestimento.

When considering sustainability, durability is a fundamental aspect. Cotto d'Este laminated porcelain, guaranteed up to 20 years, is a highly durable coating material: its life cycle is the same as that of the buildings where it is installed, more than any other coating material.

Dans une optique écologique, la durée de vie est un critère fondamental à respecter. Le gres laminé Cotto d'Este, garanti jusqu'à 20 ans, est un matériau de revêtement qui dure très longtemps : son cycle de vie, supérieur à tout autre matériau de revêtement, équivaut à celui du bâtiment où il est installé.

Wenn wir die Umweltfreundlichkeit betrachten, ist die Lebensdauer zu einem grundlegenden Schlüsselkriterium geworden. Das bis zu 20 Jahren garantierte laminierte Feinsteinzeug Cotto d'Este ist ein besonders haltbares Verkleidungsmaterial: sein Lebenszyklus entspricht dem des Gebäudes, in dem es installiert wird, mehr als jedes andere Beschichtungsmaterial.



MENO ENERGIA E MINORI EMISSIONI IN ATMOSFERA

LESS ENERGY AND LOWER EMISSIONS | MOINS D'ÉNERGIE ET MOINS D'ÉMISSIONS DANS L'ATMOSPHÈRE | WENIGER ENERGIE UND GERINGERE EMISSIONEN IN DIE ATMOSPHÄRE

L'energia necessaria a produrre 1 mq di KERLITE è pari a 190 MJ/mq** (vedi tabella a pag. 333): il 30% in meno di quella che occorre per ottenere la stessa superficie di gres porcellanato tradizionale (spessore 10 mm) o di resina epossidica. Questo fabbisogno scende a meno del 50% se prendiamo a riferimento 1 mq di parquet o di pietra naturale. Tutto ciò si traduce in una notevole riduzione delle emissioni di CO₂ per ogni mq di materiale prodotto.

The energy required to produce 1 m² of KERLITE is equal to 190 MJ/m²** (see table on p. 333), 30% less than that needed to obtain the same surface of traditional porcelain stoneware (thickness of 10 mm) or epoxy resin. This requirement drops to less than 50% if compared with 1 m² of parquet or natural stone. All this results in a significant reduction of emissions of CO₂ for each square metre of the material produced.

L'énergie nécessaire pour produire 1 m² de KERLITE équivaut à 190 MJ/m²** (voir tableau page 333), soit 30% en moins que celle qu'il faut pour obtenir la même surface de grès cérame traditionnel (épaisseur 10 mm) ou de résine époxy. Ce besoin chute en dessous de 50% si l'on prend comme référence 1 m² de parquet ou de pierre naturelle. Cela implique une réduction considérable des émissions de CO₂ pour chaque m² de matériau produit.

Die für die Produktion von 1 qm KERLITE notwendige Energie entspricht 190 MJ / m²** (siehe Tabelle auf S. 333): 30% weniger als die, die man für den Erhalt der gleichen Oberfläche aus traditionellem Feinsteinzeug (Stärke 10 mm) oder Epoxidharz benötigt. Dieser Bedarf sinkt auf mehr als 50% ab, wenn wir als Bezugspunkt Parkett oder Naturstein nehmen. All dies führt zu einer bedeutenden Verringerung der CO₂-Abgaben pro qm Produktmaterial.

*** Valori ottenuti dall'elaborazione dei dati EMAS 2013 per KERLITE e del database ICE e ECO-BAU per il gres porcellanato spessore 10 mm, che comprendono i valori di consumo energetico per l'estrazione delle materie prime (fonte: EPD di prodotti di pari spessore).

*** Values obtained from EMAS 2013 data for KERLITE and the ICE and ECO-BAU database for 10 mm thick porcelain stoneware, including the energy consumption values for the extraction of raw materials (source: EPDs of products of the same thickness).

*** Valeurs obtenues à partir de l'élaboration des données EMAS 2013 pour KERLITE et de la base de données ICE et ECO-BAU pour le grès cérame de 10 mm d'épaisseur, qui comprennent les valeurs de consommation énergétique pour l'extraction des matières premières (source: EPD de produits d'épaisseur égale).

*** Werte aus der Datenverarbeitung EMAS 2013 für KERLITE und der Datenbank ICE und ECO-BAU für Feinsteinzeug 10 mm Stärke, einschließlich der Energieverbrauchswerte für die Gewinnung von Rohstoffen (Quelle: EPD von Produkten der gleichen Stärke).



MINORE INCIDENZA DEI TRASPORTI

LESS ENVIRONMENTAL IMPACT OF TRANSPORT | RÉDUCTION DE L'IMPACT DES TRANSPORTS | WENIGER SCHÄDLICHE AUSWIRKUNGEN DURCH DEN TRANSPORT

Se consideriamo l'incidenza sull'ambiente del trasporto dal sito produttivo al cantiere, dobbiamo pensare che un autotreno carico di sola KERLITE muove tre volte i mq di un autotreno di generico gres porcellanato spessore 10 mm. Ciò vuol dire che, a parità di metri quadri trasportati, ogni 3 camion di gres porcellanato ne parte solo 1 di KERLITE.

It is important to add the environmental impact of transport from the production facility to the construction site. A trailer truck loaded only with Kerlite transports three times the amount, in sqm, of standard 10 mm thick porcelain tiles. This means that to carry the same amount of sqm of tiles, three trucks are needed for traditional porcelain as against one truck for Kerlite.

Si l'on considère par ailleurs l'impact environnemental du transport du site de production au chantier, on doit penser qu'un camion chargé de KERLITE uniquement transporte trois fois plus de m² qu'un camion chargé de grès cérame ordinaire de 10 mm d'épaisseur. Cela veut dire que pour une quantité égale de m² transportés, 3 camions de grès cérame sont nécessaires pour 1 seul de KERLITE.

Wenn wir zudem die Umweltbelastung durch den Transport von der Produktionsstätte zur Baustelle betrachten, müssen wir bedenken, dass eine LKW-Ladung mit ausschließlich KERLITE drei Mal mehr Quadratmeter transportiert als ein Lkw mit dem traditionellen 10 mm starken Feinsteinzeug. Dies bedeutet für die gleichen transportierten Quadratmeter Feinsteinzeug: 3 LKW für das traditionelle 10mm Feinsteinzeug nur 1 LKW für KERLITE.



CARTA DI IDENTITÀ AMBIENTALE

ENVIRONMENTAL IDENTITY CARD

KERLITE 3PLUS

GRES PORCELLANATO LAMINATO RINFORZATO CON FIBRA DI VETRO
LAMINATED PORCELAIN STONWARE REINFORCED WITH FIBREGLASS

	3,5 mm SPESSORE / THICKNESS	-65%
	7,8 kg/m² PRODOTTO FINITO / FINISHED PRODUCT	-65%
	65 l/m² FABBISOGNO D'ACQUA / WATER REQUIRED	-80%
	190 MJ/m² FABBISOGNO DI ENERGIA / ENERGY REQUIRED	-30%
	14,1 kgCO₂/m² CO ₂ EMESSA IN ATMOSFERA / CO ₂ EMITTED IN THE ATMOSPHERE	-30%
	3840 m² • camion / m² • truck INCIDENZA DEL TRASPORTO / TRANSPORT FACTOR	-66%

10 MM

GRES PORCELLANATO GENERICO
GENERIC PORCELAIN STONWARE

	10 mm SPESSORE / THICKNESS	
	24 kg/m² PRODOTTO FINITO / FINISHED PRODUCT	
	309 l/m² FABBISOGNO D'ACQUA / WATER REQUIRED	
	275 MJ/m² FABBISOGNO DI ENERGIA / ENERGY REQUIRED	
	20,6 kgCO₂/m² CO ₂ EMESSA IN ATMOSFERA / CO ₂ EMITTED IN THE ATMOSPHERE	
	1280 m² • camion / m² • truck INCIDENZA DEL TRASPORTO / TRANSPORT FACTOR	







DESTINAZIONI D'USO



INTENDED USES | UTILISATIONS PRÉVUES | EINSATZBEREICHE



La posa deve essere eseguita secondo le norme pubblicate sul Manuale Tecnico Kerlite.

Installation must be performed in compliance with the standards published on the Kerlite Technical Manual. | La pose doit être effectuée selon les normes publiées dans le Manuel Technique Kerlite. | Die Verlegung muss nach den Vorschriften im Technischen Handbuch von Kerlite erfolgen.

	POSA A PAVIMENTO Situazioni applicative sia per interventi di nuova costruzione che di ristrutturazioni con posa in sovrapposizione a pavimenti preesistenti.	FLOOR INSTALLATION For new buildings and refurbishing with installation on existing floors.
 IN INTERNO INTERIORS EN INTÉRIEUR INNENBEREICHE	Residenziale (cucine, bagni, living, aree comuni condominiali, ed ogni altro ambiente di uso residenziale).	Residential (kitchens, bathrooms, living rooms, common apartment block areas and any other residential environment).
	Commerciale leggero (uffici, uffici aperti al pubblico, sale d'attesa, negozi, bagni, sale di ristoranti, autosaloni, bar, cinema, ambulatori/cliniche).	Light commercial (offices, offices open to the general public, waiting rooms, shops, bathrooms, restaurant dining rooms, car showrooms, bars, cinemas, surgeries/clinics).
	Commerciale intensivo (aree comuni di centri commerciali, hall di alberghi, mense, fast food, discoteche, ospedali) ad esclusione di zone sottoposte al passaggio di carichi pesanti concentrati (ad es. carrelli a ruote dure).	Heavy duty commercial (public areas of shopping centres, hotel halls, canteens, fast food restaurants, clubs, hospitals) with the exception of areas subject to heavy loads (e.g. trolleys with hard wheels).
 IN ESTERNO EXTERIORS EN EXTÉRIEUR AUSSENBEREICHE	A condizione che le superfici siano coperte (es. loggie, balconi coperti, ecc.) e perfettamente impermeabilizzate. Si consiglia l'utilizzo di formati non superiori a 100x100cm.	Upon condition that surfaces are sheltered (e.g. loggias, covered balconies, etc.) and made totally impervious. The use of sizes that are not larger than 100x100 cm is recommended.
	POSA A PARETE Situazioni applicative sia per interventi di nuova costruzione che di ristrutturazioni con posa in sovrapposizione a pavimenti preesistenti.	WALL INSTALLATION For new buildings and refurbishing with installation on existing floors.
 IN INTERNO INTERIORS EN INTÉRIEUR INNENBEREICHE	Qualunque ambiente residenziale e commerciale dove non si devono praticare fori e/o tagli interni	Any residential and commercial area where holes and/or cuts are not necessary.
	Qualunque ambiente residenziale e commerciale dove si devono praticare fori e/o tagli interni	Any residential and commercial area where holes and/or cuts are necessary.
 IN ESTERNO EXTERIORS EN EXTÉRIEUR AUSSENBEREICHE	Su sottofondo di calcestruzzo o intonaco dove si devono praticare tagli angolari e utilizzare grandi formati.	On concrete or plaster supports, where corner cuts and large sizes are necessary.
	DESTINAZIONI SPECIALI	SPECIAL USES
FACCIAE VENTILATE, RIVESTIMENTI TERMICI A CAPPOTTO, RIVESTIMENTO VASCHE E PISCINE, SUPERFICI DA RIVESTIRE NEL SETTORE DELL'ARREDAMENTO. VENTILATED FACADES, THERMAL INSULATION CLADDING SYSTEMS, TILING FOR SWIMMING POOLS, FOR FURNITURE SURFACES. FAÇADES VENTILÉES, REVÊTEMENTS THERMIQUES À MUR-MANTEAU, REVÊTEMENT BASSINS ET PISCINES, SURFACES À REVÊTIR DANS LE SECTEUR DE LA DÉCORATION. HINTERLÜFTETE FASSADEN, THERMISCHE UMMANTELUNGEN, BECKEN UND SCHWIMMBECKEN, VERKLEIDUNG VON OBERFLÄCHEN IN DER MÖBELBRANCHE.	In funzione delle specifiche del progetto, e in abbinamento a sistemi costruttivi indicati da Cotto d'Este e approvati dalla Direzione Lavori.	Depending on project specifications and in combination with the construction systems recommended by Cotto d'Este and approved by the Installation Supervisor.

POSE AU SOL Application dans des nouvelles constructions ou des restructurations avec pose sur des sols préexistants.	BODENVERLEGUNG Für neubauten und renovierungen mit verlegung auf vorhandenen böden.			
Résidentiel (cuisines, salles de bains, salles de séjour, zones de copropriété collectives, et tout autre espace à usage résidentiel).	Wohnbereiche (Küchen, Badezimmer, Wohnzimmer, Gemeinschaftsflächen in Mehrfamilienhäusern und alle sonstigen Wohnbereiche).	● except: WONDERWALL (Articoli decorati a freddo/ Items decorated with cold digital technology)*	●	●
Commercial léger (bureaux, bureaux ouverts au public, salles d'attente, magasins, salles de bains, salles de restaurants, salons automobiles, bars, cinémas, dispensaires/cliniques).	Leichte gewerbliche Anwendungen (Büroräume, öffentliche Büros, Wartezimmer, Geschäfte, Toiletten, Gaststätten, Autohäuser, Cafés, Kinos, Praxen/Kliniken).	● except: OVER SOFT - WONDERWALL (Articoli decorati a freddo/ Items decorated with cold digital technology)*	● except: GLOSSY (EXEDRA - ULTRAWHITE)	●
Commercial intensif (zones communes de centres commerciaux, halls d'hôtels, cantines, fast-foods, discothèques, hôpitaux). Sauf les zones soumises au passage de charges lourdes concentrées (ex. : chariots à roues dures).	Intensive gewerbliche Anwendungen (Gemeinschaftsbereiche in Einkaufszentren, Hotelhallen, Kantinen, Fastfood-Restaurants, Diskotheken, Krankenhäuser). Ausgenommen Bereiche mit Durchfahrtsverkehr von konzentrierten Schwerlasten (z.B. Wagen mit Hartgummirädern).		● except: SILK (EXEDRA - ELEGANCE) - GLOSSY (EXEDRA - ULTRAWHITE)	● except: VANITY
La pose en extérieur est possible à condition que les surfaces soient couvertes (loggias, balcon, etc.) et parfaitement imperméabilisées. Il est conseillé d'utiliser des formats non supérieurs à 100x100 cm.	Die Verlegung in Außenbereichen ist möglich, wenn die Oberflächen überdacht und vollkommen abgedichtet sind (überdachte Balkons, Veranden, usw.). Es sollten keine größeren Formate als 100x100 cm verwendet werden.	● except: WONDERWALL (Articoli decorati a freddo/ Items decorated with cold digital technology)*	●	● except: VANITY
POSE AU MUR Application dans des nouvelles constructions ou des restructurations avec pose sur des sols préexistants.	WANDVERLEGUNG Für neubauten und renovierungen mit verlegung auf vorhandenen böden.			
Toute zone résidentielle et commerciale où il ne faut pas percer de trous ni pratiquer de découpes internes.	Fuer jede Wohn- und Handelsbereich in denen keine internen Bohrungen und/oder Schnitte gefertigt werden müssen.	●	●	●
Toute zone résidentielle et commerciale où il faut percer de trous et/ou pratiquer de découpes internes.	Fuer jede Wohn- und Handelsbereich in denen internen Bohrungen und/oder Schnitte gefertigt werden müssen.	●	●	●
Sur chape en béton ou enduit où il est nécessaire d'exécuter des découpes angulaires et d'utiliser de grands formats.	Auf Untergründen aus Beton oder Putz, auf denen Eckschnitte gefertigt und Großformate verwendet werden müssen.	● except: WONDERWALL (Articoli decorati a freddo/ Items decorated with cold digital technology)*	●	●
UTILISATIONS SPÉCIALES	SPEZIELLE VERWENDUNGSZWECKE			
En fonction des caractéristiques du projet et en combinaison avec les systèmes de construction indiqués par Cotto d'Este et approuvés par les maîtres d'œuvre.	In Funktion der Projektangaben und in Kombination mit Konstruktionssystemen, die Cotto d'Este vorgibt und die Arbeitsleitung genehmigt.	● except: WONDERWALL (Articoli decorati a freddo/ Items decorated with cold digital technology)*	●	●

* Freestyle - Sketch - Script - Venice - Color Ballet - Jungle - Dream - Frame - Zen

Per le informazioni di posa riguardanti la serie Wonderwall vedi pag. 368-369 | For information on the installation of the Wonderwall series please see page 368-369

Pour plus d'informations concernant la pose de la série Wonderwall, consultez la page 368-369 | Für die Verlegungsinformationen betreffend der Serie Wonderwall siehe Seite 368-369

CARATTERISTICHE TECNICHE TECHNICAL CHARACTERISTICS | CARACTÉRISTIQUES TECHNIQUES | TECHNISCHE EIGENSCHAFTEN



RESISTENZA ALL'USURA DA CALPESTIO RESISTANCE TO TRAMPLING WEAR | RÉSISTANCE À L'USURE DUE AU PIÉTINEMENT | ABRIEBFESTIGKEIT

ISO 10545-7

Le superfici smaltate (GL) sono testate secondo il metodo PEI che valuta l'alterazione della superficie dopo una serie di cicli abrasivi effettuati con l'apposita attrezzatura.

Abrasion visibile a:

PEI 0 = 100 giri
PEI I = 150 giri
PEI II = 600 giri
PEI III = 750 o 1.500 giri
PEI IV = 2.100, 6.000 o 12.000 giri
PEI V = Maggiore di 12.000 giri

Glazed (GL) surfaces are tested using the PEI method which assesses the change in the surface after a series of abrasive revolution cycles performed with special equipment

Visible abrasion at:

PEI 0 = 100 rotations
PEI I = 150 rotations
PEI II = 600 rotations
PEI III = 750 o 1.500 rotations
PEI IV = 2.100, 6.000 o 12.000 rotations
PEI V = More than 12.000 rotations

Les surface émaillées (GL) sont testées selon la méthode PEI qui évalue l'altération de la surface à l'issue d'une série de cycles d'abrasion effectués à l'aide des instruments prévus à cet effet.

Abrasion visible:

PEI 0 = à 100 tours
PEI I = à 150 tours
PEI II = à 600 tours
PEI III = à 750 ou 1500 tours
PEI IV = à 2100, 6000 ou 12000 tours
PEI V = au-delà de 12000 tours

Glasierte Oberflächen (GL) werden nach der PEI-Methode getestet, welche die Veränderung der Oberfläche nach einer Reihe Scheuerzyklen mit der entsprechen-den Ausrüstung bewertet.

Abrieb sichtbar nach:

PEI 0 = 100 Umdrehungen
PEI I = 150 Umdrehungen
PEI II = 600 Umdrehungen
PEI III = 750 oder 1.500 Umdrehungen
PEI IV = 2.100, 6.000 oder 12.000 Umdrehungen
PEI V = Mehr als 12.000 Umdrehungen



RESISTENZA ALL'ABRASIONE PROFONDA DEEP ABRASION RESISTANCE | RÉSISTANCE À L'ABRASION PROFONDE | WIDERSTAND GEGEN TIEFENABRIEB

ISO 10545-6

Le superfici non smaltate (UGL) sono sottoposte al metodo dell'abrasione profonda; questo test determina il volume di materiale che viene asportato dalla superficie con un disco abrasivo dopo 150 giri. Tanto minore è il volume asportato tanto più resistente è il materiale.

Unglazed (UGL) surfaces are subjected to the deep abrasion method; this test measures the value of material removed from the surface with an abrasive disc after 150 rotations cycles. The lower the volume removed, the more resistant the material.

Les surfaces non-émaillées sont soumises à la méthode de l'abrasion profonde: ce test détermine le volume de matériau éliminé de la surface à l'aide d'un disque abrasif au bout de 150 tours. La résistance est d'autant plus importante que le volume de matériau éliminé est faible.

Unglasierte Oberflächen (UGL) werden der Tiefenverschleiss-Messmethode unterzogen. Dieser Test bestimmt das Materialvolumen, das mit einer Schleifscheibe nach 150 Umdrehungen von der Oberfläche abgetragen wird. Je geringer das abgetragene Volumen, um so beständiger ist das Material.



RESISTENZA AL GELO FROST RESISTANCE | RÉSISTANCE AU GEL | FROSTBESTÄNDIGKEIT

ISO 10545-12

I materiali ceramici posati in esterno subiscono danneggiamenti dovuti al gelo se possiedono una certa porosità. Quando l'acqua eventualmente assorbita ghiaccia, aumenta il proprio volume determinando forti sollecitazioni meccaniche interne che possono tradursi in distacchi di materiale sulla superficie. Le mattonelle Cotto d'Este sono ingelive quando, in virtù della porosità quasi nulla, superano sempre il test ISO 10545-12 che prevede 100 cicli gelo/disgelo tra -5°C e +5°C senza subire nessun danno.

Ceramic materials laid outdoors suffer frost damage if their porosity is above a certain level. When any water absorbed freezes, it increases in volume, generating strong internal mechanical stresses which may cause the material to detach from the underlying surface. Cotto d'Este tiles are frostproof because, thanks to their porosity value of virtually nil, they always pass the ISO 10545-12 test comprising 100 freeze/thaw cycles between -5°C and +5°C without suffering any damage.

Les matériaux céramiques posés en extérieur subissent des dommages provoqués par le gel lorsqu'ils sont légèrement poreux. Lorsque l'eau éventuellement absorbée gèle, son volume augmente, ce qui a pour effet d'exercer de fortes sollicitations mécaniques internes qui peuvent se traduire par un détachement des carreaux de la surface de pose. Leur porosité étant quasi nulle, les carreaux Cotto d'Este sont ingélifs. Ils ont en effet réussi avec succès le test 10545-12 qui prévoit 100 cycles de gel/dégel entre -5°C et +5°C sans subir aucun dommage.

Die in Außenbereichen verlegten keramischen Materialien werden durch Frost beschädigt, wenn sie eine gewisse Porosität aufweisen. Wenn das ggf. angenommene Wasser vereist, wird dessen Volumen größer, was zu starken inneren mechanischen Beanspruchungen führt, die zur Ablösung von Material an der Oberflächen führen können. Die Fliesen von Cotto d'Este sind frostbeständig, wenn sie dank ihrer fast vollkommen fehlenden Porosität immer den Test nach ISO 10545-12 bestehen, der 100 Frier- und Tauzyklen zwischen -5°C und +5°C vorsieht, ohne irgend welche Schäden davon zu tragen.



RESISTENZA ALL'ATTACCO CHIMICO RESISTANCE TO CHEMICAL ETCHING | RÉSISTANCE À L'ATTAQUE CHIMIQUE | BESTÄNDIGKEIT GEGEN CHEMIKALIEN

ISO 10545-13

Il metodo determina la resistenza chimica di piastrelle sia smaltate che non smaltate, utilizzando acidi (cloridrico, citrico, lattico) e basi (idrossido di potassio) a bassa (L) e ad alta (H) concentrazione. La classificazione viene effettuata come segue:
LA, HA: Resistente;
LB, HB: Modifica dell'aspetto della superficie;
LC, HC: Perdita parziale o completa della superficie originale.

The method measures the chemical resistance of both glazed and unglazed tiles, using acids (hydrochloric, citric and lactic) and bases (potassium hydroxide) at low (L) and high (H) concentration. The classification is as follows:
LA, HA: Resistant;
LB, HB: Changes in appearance of surface;
LC, HC: partial or complete loss of original surface.

La méthode permet de déterminer la résistance chimique de carreaux émaillés et non-émaillés en utilisant différents acides (chlorhydrique, citrique et lactique) et des bases (hydroxyde de potassium) à basse (L) et haute (H) concentration. La classification est la suivante:
LA et HA: résistant;
LB et HB: modification de l'aspect de la surface;
LC et HC: perte partielle ou totale de la surface d'origine.

Die Methode bestimmt die Chemikalienbeständigkeit sowohl glasierter Fliesen als auch unglasierter Fliesen, unter Verwendung von Säuren (Salzsäure, Zitronensäure, Milchsäure) und Laugen (Kaliumhydroxyd) in schwacher (L) und starker (H) Konzentration. Die Einstufung findet wie folgt statt:
LA, HA: beständig;
LB, HB: Veränderung des Aussehens an der Oberfläche;
LC, HC: Teilweiser oder vollständiger Verlust der Originaloberfläche.



RESISTENZA ALLE MACCHIE STAIN RESISTANCE | RÉSISTANCE AUX TACHES | FLECKENBESTÄNDIGKEIT

ISO 10545-14

La superficie d'esercizio viene posta a contatto con tre agenti macchianti, olio d'oliva, soluzione alcolica di iodio e verde cromo in olio leggero; dopo 24 ore si procede alla pulizia.
Classe 5 - macchia rimossa con acqua calda corrente per 5 minuti;
Classe 4 - macchia rimossa mediante pulizia manuale con detergente debole;
Classe 3 - macchia rimossa mediante pulizia meccanica con detergente forte;
Classe 2 - macchia rimossa mediante immersione in idoneo solvente per 24 ore;
Classe 1 - macchia non rimossa.

The operating surface is subject to three staining agents, olive oil, iodine alcohol solution and chromium green in light oil; after 24 hours the surface is cleaned.
Class 5 - stain removed with warm water running for 5 minutes;
Class 4 - stain removed by manual cleaning with mild detergent;
Class 3 - stain removed by mechanical cleaning with strong detergent;
Class 2 - stain removed by dipping in suitable thinner for 24 hours;
Class 1 - stain not removed.

La surface de travail est mise au contact de trois agents tachants, huile d'olive, solution alcoolique à base d'iode et de chrome vert dans une huile légère; le nettoyage est effectué après 24 heures.
Classe 5 - tache enlevée à l'eau chaude courante (5 minutes);
Classe 4 - tache enlevée par nettoyage manuel avec un produit léger;
Classe 3 - tache enlevée par nettoyage mécanique avec un produit fort;
Classe 2 - tache enlevée par immersion dans un solvant approprié pendant 24 heures;
Classe 1 - tache tenace.

Auf die Betriebsoberfläche werden drei fleckenbildende Agens, Olivenöl, eine alkoholische Jod-Lösung und Grünchrom in Leichtöl gegeben. Nach 24 Stunden erfolgt die Reinigung.
Klasse 5 - Der Fleck verschwindet nach einer 5-minütigen Behandlung mit warmem Wasser.
Klasse 4 - Der Fleck verschwindet nach einer Behandlung von Hand mit einem leichten Reinigungsmittel.
Klasse 3 - Der Fleck verschwindet nach einer mechanischen Behandlung mit einem starken Reinigungsmittel.
Klasse 2 - Der Fleck verschwindet, nachdem die Oberfläche 24 Stunden lang in einem entsprechenden Lösungsmittel eingelegt wurde.
Klasse 1 - Der Fleck bleibt.



ASSORBIMENTO D'ACQUA WATER ABSORPTION | ABSORPTION D'EAU | WASSERAUFNAHMEFÄHIGKEIT

ISO 10545-3

La capacità di un materiale ceramico di assorbire acqua è in relazione alla sua porosità. I prodotti Cotto d'Este, grazie alle materie prime molto pregiate e alle avanzate tecnologie produttive, offrono sempre una compattezza eccezionale e conseguentemente valori minimi di porosità. Il valore esprime la percentuale di assorbimento riferito alla massa.

A ceramic material's capacity to absorb water depends on its porosity. Thanks to the choice quality raw materials used and the state-of-the-art production technologies, Cotto d'Este products are always outstandingly compact, meaning that their porosity values are minimal. The value expresses the percentage water absorption by weight.

La capacité d'absorption d'eau d'un matériau céramique est fonction de sa porosité. Grâce à la très haute qualité des matières premières utilisées et à des technologies de production avancées, les produits Cotto d'Este garantissent un degré de compacité exceptionnel synonyme de porosité minime. La valeur exprime le pourcentage d'absorption par rapport à la masse.

Die Wasseraufnahmefähigkeit eines keramischen Materials ist von seiner Porosität abhängig. Cotto d'Este Produkte bieten dank ihrer sehr hochwertigen Rohstoffe und ihrer fortschrittlichen Produktionstechnologien stets eine ausgezeichnete kompakte Beschaffenheit und demzufolge minimale Porositätswerte. Der Wert drückt den Aufnahmeprozentsatz im Verhältnis zur Masse aus.

**RESISTENZA ALLO SCIVOLAMENTO**

SLIP RESISTANCE | RÉSISTANCE ÀU GLISSEMENT | RUTSCHFESTIGKEIT

DIN 51130

Questo test prevede un operatore posto su un piano rivestito di mattonelle da testare. Il piano inizialmente orizzontale viene via via inclinato fino al momento in cui l'operatore inizia a scivolare. L'angolo corrispondente all'inclinazione del piano al momento dello scivolamento determina la classificazione.

	$\alpha < 6^\circ$ = non classificate
	$6^\circ \leq \alpha \leq 10^\circ$ = R9
	$10^\circ < \alpha \leq 19^\circ$ = R10
	$19^\circ < \alpha \leq 27^\circ$ = R11
	$27^\circ < \alpha \leq 35^\circ$ = R12
	$\alpha > 35^\circ$ = R13

In this test, an operator stands on a surface covered with tiles for testing. The surface, initially horizontal, is gradually tilted until the moment when the operator starts to slip. The angle of tilt of the surface when slipping starts provides the rating.

	$\alpha < 6^\circ$ = not classified
	$6^\circ \leq \alpha \leq 10^\circ$ = R9
	$10^\circ < \alpha \leq 19^\circ$ = R10
	$19^\circ < \alpha \leq 27^\circ$ = R11
	$27^\circ < \alpha \leq 35^\circ$ = R12
	$\alpha > 35^\circ$ = R13

Le test de mesure de ce paramètre prévoit la présence d'un opérateur sur un plan revêtu des carreaux à tester. Le plan, initialement horizontal, est progressivement incliné jusqu'à ce que l'opérateur commence à glisser. L'angle correspondant à l'inclinaison du plan au moment où l'opérateur commence à glisser détermine la classification.

	$\alpha < 6^\circ$ = non classé
	$6^\circ \leq \alpha \leq 10^\circ$ = R9
	$10^\circ < \alpha \leq 19^\circ$ = R10
	$19^\circ < \alpha \leq 27^\circ$ = R11
	$27^\circ < \alpha \leq 35^\circ$ = R12
	$\alpha > 35^\circ$ = R13

Hier steht ein Bediener auf einer mit zu testenden Fliesen verkleideter Fläche. Die anfangs horizontale Fläche wird nach und nach geneigt, bis der Bediener zu rutschen beginnt. Der Neigungswinkel der Fläche bei Rutschbeginn bestimmt die Bewertungsgruppe.

	$\alpha < 6^\circ$ = nicht klassifizierbar
	$6^\circ \leq \alpha \leq 10^\circ$ = R9
	$10^\circ < \alpha \leq 19^\circ$ = R10
	$19^\circ < \alpha \leq 27^\circ$ = R11
	$27^\circ < \alpha \leq 35^\circ$ = R12
	$\alpha > 35^\circ$ = R13

DIN 51097

Il metodo si prefigge di misurare l'idoneità delle piastrelle per la posa in ambienti dove si cammina a piedi scalzi (es. bordi piscine, docce, ecc.). Un operatore cammina a piedi scalzi su di un piano inclinabile sul quale sono posate le piastrelle in esame bagnate con una soluzione acquosa di sapone. Il piano viene via via inclinato, e l'angolo in corrispondenza del quale l'operatore inizia a scivolare determina la classificazione delle piastrelle, come riportato nella tabella seguente:

$\alpha < 12^\circ$	non classificate
$12^\circ \leq \alpha < 18^\circ$	A
$18^\circ \leq \alpha < 24^\circ$	B (A+B)
$\alpha \geq 24^\circ$	C (A+B+C)

The method aims to measure the tiles' suitability for laying in locations where people walk barefoot (e.g. edges of swimming-pools, showers, etc.). An operator walks barefoot over a tilting surface laid with the tiles for testing, wet with a soap and water solution. The surface is gradually tilted and the angle of tilt at which the operator starts to slip provides the tiles' rating, as shown in the table below.

$\alpha < 12^\circ$	not classified
$12^\circ \leq \alpha < 18^\circ$	A
$18^\circ \leq \alpha < 24^\circ$	B (A+B)
$\alpha \geq 24^\circ$	C (A+B+C)

La méthode vise à mesurer la conformité des carreaux pour une pose sur des espaces au sein desquels l'on marche pieds nus (abords de piscine, douche, etc.). Un opérateur marche pieds nus sur un plan inclinable sur lequel sont posés des carreaux mouillés à l'aide d'une solution d'eau et de savon. Le plan est progressivement incliné et l'angle correspondant à l'inclinaison du plan au moment où l'opérateur commence à glisser détermine la classification des carreaux comme indiquée ci-dessous:

$\alpha < 12^\circ$	non classé
$12^\circ \leq \alpha < 18^\circ$	A
$18^\circ \leq \alpha < 24^\circ$	B (A+B)
$\alpha \geq 24^\circ$	C (A+B+C)

Diese Methode misst die Eignung der Fliesen für die Verlegung in Barfuß-Bereichen (z.B. Schwimm-beckenränder, Duschen, usw.). Ein Bediener geht barfuß auf einer geneigten Fläche, auf der mit einer Seifenwasserlösung nasse Fliesen verlegt sind. Die Fläche wird nach und nach geneigt und der Neigungswinkel, an dem der Bediener zu rutschen beginnt, bestimmt die Bewertungsgruppe der Fliesen, laut folgender Tabelle:

$\alpha < 12^\circ$	nicht klassifizierbar
$12^\circ \leq \alpha < 18^\circ$	A
$18^\circ \leq \alpha < 24^\circ$	B (A+B)
$\alpha \geq 24^\circ$	C (A+B+C)

BCR TORTUS

Metodo inglese per la determinazione del coefficiente di attrito delle superfici in base alla resistenza opposta al trascinarsi di una apparecchiatura (tortus) che viene fatta transitare sulla superficie stessa. Il metodo si basa, mediante un dispositivo mobile, di determinare il coefficiente di attrito che materiali standardizzati, quali gomma e cuoio, hanno in condizioni di asciutto o bagnato una volta a contatto con una determinata superficie da pavimentazione. Come già indicato sopra il "tortus test" il metodo di riferimento per la legislazione nazionale di cui al paragrafo 8.2.2 del D.M. 236/89 che nelle condizioni di Gomma asciutta e Cuoio bagnato prevede un coefficiente > 0,40. La macchina di prova per la rilevazione del coefficiente di attrito su superfici bagnate è il sistema Digital Sliptester Floor Slide Control FSC 2000, sistema computerizzato.

$\mu < 0,20$	Scivolosità pericolosa
$0,20 \leq \mu < 0,40$	Scivolosità eccessiva
$0,40 \leq \mu < 0,75$	Attrito soddisfacente
$\mu \geq 0,75$	Attrito eccellente

English method for determining the coefficient of friction of surfaces based on the resistance opposed to the movement of a tester instrument (Tortus) that traverses the surface to be tested. The method is based on the use of a mobile device to determine the coefficient of friction that standard materials, such as rubber and leather, have in wet or dry conditions further to contact with a certain floor covering material. As explained above, the "Tortus test" is the reference method for National legislation under paragraph 8.2.2 of Ministerial Decree 236/89, which envisages a coefficient equal to >0.40 in dry Dry Rubber and Wet Leather conditions. The friction coefficient testing machine for wet surfaces is the Digital Sliptester Floor Slide Control FSC 2000 system, which is computer-controlled.

$\mu < 0,20$	Dangerous sliding
$0,20 \leq \mu < 0,40$	Excessive sliding
$0,40 \leq \mu < 0,75$	Satisfaction friction
$\mu \geq 0,75$	Excellent friction

Méthode anglaise pour la détermination du coefficient de frottement des surfaces en fonction de la résistance opposée au glissement d'un appareil (Tortus) sur la surface elle-même. Cette méthode consiste, par le biais d'un dispositif mobile, à déterminer le coefficient de frottement que des matières standardisées, telles que le caoutchouc et le cuir, possèdent sur des surfaces sèches ou mouillées en contact avec un sol bien précis. Ledit « Tortus Test », méthode de référence pour la législation nationale visée au paragraphe 8.2.2 du D.M. 236/89, prévoit dans des conditions de Caoutchouc sec et Cuir mouillé un coefficient > 0,40. Le mesurage du coefficient de frottement sur des surfaces mouillées est obtenu au moyen du système informatisé Digital Sliptester Floor Slide Control FSC 2000.

$\mu < 0,20$	Glissance dangereuse
$0,20 \leq \mu < 0,40$	Glissance excessive
$0,40 \leq \mu < 0,75$	Frottement satisfaisant
$\mu \geq 0,75$	Frottement excellent

Englische Methode zur Bestimmung des Reibungskoeffizienten der Oberflächen aufgrund des Widerstandes, der der Schleppkraft einer Apparatur (Tortus) geleistet wird, die die Oberfläche selbst durchquert. Die Methode basiert darauf, mit Hilfe einer beweglichen Vorrichtung, den Reibungskoeffizienten zu ermitteln, den Standardmaterialien wie Gummi und Leder in trockenem und nassem Zustand in Kontakt mit einer bestimmten Fußbodenfläche aufweisen. Wie bereits oben erwähnt, ist die Tortus-Testmethode die Grundlage für die nationale Gesetzgebung, siehe Paragraph 8.2.2 des Ministerialerlasses 236/89, die für trockenes Gummi und nasses Leder einen Koeffizienten > 0,40 vorsieht. Die Testmaschine zur Ermittlung des Reibungskoeffizienten auf nassen Oberflächen ist das EDV-System Digital Sliptester Floor Slide Control FSC 2000.

$\mu < 0,20$	Gefährliche Rutschigkeit
$0,20 \leq \mu < 0,40$	Übermäßige Rutschigkeit
$0,40 \leq \mu < 0,75$	Mittelmäßige Reibung
$\mu \geq 0,75$	Ausgezeichnete Reibung

ANSI A326.3

Coefficiente dinamico di attrito (DCOF): a volte chiamato coefficiente d'attrito. Questo è il rapporto tra la forza necessaria a mantenere una superficie già in movimento di scorrimento su un'altra diviso per il peso (o forza normale) di un oggetto. Questa forza è una proprietà dei materiali delle due superfici. DCOF è solitamente inferiore a SCOF per gli stessi materiali. Contaminanti quali sporczia, acqua, sapone, olio o grasso possono modificare questo valore. Se non diversamente specificato, piastrelle adatte per spazi interni che dovrebbero essere calpestati quando è bagnato devono avere un DCOF umido di 0.42 o superiore durante il test con la soluzione di SLS. Tuttavia, le piastrelle con una DCOF di 0.42 o superiore non sono necessariamente adatte per tutti i progetti. L'identificatore stabilisce piastrelle idonee per un progetto specifico, considerando a titolo di esempio, ma non in limitazione, tipo di impiego, traffico previsto, contaminanti, manutenzione e le linee guida e le raccomandazioni dei produttori.

AS/NZS 4586 – APPENDICE A

La prova del pendolo bagnato per la misurazione della resistenza allo scivolamento (AS/NZS 4586 Appendice A) è generalmente eseguita utilizzando uno strumento di prova a pendolo Wessex oppure Munro - Stanley London. Il dispositivo a pendolo è portatile ed è composto da un piede appesantito e da un cursore di prova che oscilla verso il basso e scorre su una superficie bagnata con acqua. Il piede comprende un cursore in gomma con carica a molla che esercita una forza prestabilita sul campione mentre scivola sulla superficie. Gli esiti della prova sono espressi sotto forma di British Pendulum Number (BPN) e classificati secondo la norma AS/NZS 4586, come indicato nella tabella seguente.

La AS/NZS 4586 classifica la superficie sulla base del valore BPN medio, mentre la norma australiana per prove di resistenza allo scivolamento AS/NZS 4663 esprime l'esito come BPN. La AS/NZS 4663 fornisce inoltre una stima del contributo teorico del pavimento al rischio di scivolamento in presenza di acqua, come indicato di seguito:

Valore medio per prova a pendolo BPM Pendulum mean BPM		Classificazione AS/NZS 4586 AS/NZS 4586 Classification	AS/NZS 4663 Contributo teorico del pavimento al rischio di scivolamento sul bagnato AS/NZS 4663 Notional contribution of the floor surface to the risk of slipping when wet
Four S	TRL		
> 54	> 44	V (P5:2013)	Molto basso / Very low
45 - 54	40 - 44	W (P4:2013)	Basso / Low
35 - 44	-	X (P3:2013)	Moderato / Moderate
25 - 34	-	Y (P2:2013)	Alto / High
< 25	-	Z (P1:2013)	Molto alto / Very high

Mentre si possono utilizzare 2 tipi di materiale per il cursore in gomma, la suola da scarpa simulata standard (Four S) è generalmente accettata come materiale per valutare la resistenza allo scivolamento per persone che indossano calzature adeguate. Si utilizza prevalentemente gomma TRL (Transport Research Laboratory) per superfici ad alta resistenza allo scivolamento o superfici strutturate. Le attività di ricerca hanno dimostrato che la gomma TRL fornisce un'indicazione più affidabile della resistenza allo scivolamento a piedi nudi, data la natura più morbida e cedevole del materiale che è più simile alla pelle umana rispetto alla gomma Four S.

Dynamic Coefficient of Friction (DCOF): sometimes called kinetic coefficient of friction. This is the ratio of the force necessary to keep a surface already in motion sliding over another divided by the weight (or normal force) of an object. This force is a materials property of the two surfaces. DCOF is usually less than SCOF for the same materials. Contaminants such as dirt, water, soap, oil, or grease can change this value.

Unless otherwise specified, tiles suitable for interior spaces expected to be walked upon when wet shall have a wet DCOF of 0.42 or greater when tested using SLS solution. However, tiles with a DCOF of 0.42 or greater are not necessarily suitable for all projects. The specifier shall determine tiles appropriate for specific project conditions, considering by way of example, but not in limitation, type of use, traffic, expected contaminants, expected maintenance, expected wear2, and manufacturers' guidelines and recommendations.

AS/NZS 4586 - APPENDIX A

The wet pendulum slip resistance test (AS/NZS 4586 Appendix A) is generally conducted using a Wessex or Munro - Stanley London Pendulum Friction Tester. This pendulum device is portable and consists of a weighted foot with a test slider that swings down and slides across the surface wetted with water. The weighted foot comprises a spring loaded rubber test slider that exerts a prescribed force over the specimen as it slides across the surface. The results of expressed as a British Pendulum Number (BPN) and classified according to AS/NZS 4586 as shown in the table below: AS/NZS 4586 classifies the surface based on the mean BPN where the Australian Standard for onsite slip testing AS/NZS 4663 expresses the result in terms of BPN. AS/NZS 4663 also provides a notional contribution of the floor surface to the risk of slipping when water wet as given below:

While there are 2 rubber slider materials that may be used, Four S (simulated standard shoe sole) is generally accepted as the material to assess the slip resistance for the general public wearing suitable footwear. TRL (Transport Research Laboratory) rubber is predominantly used for highly slip resistant and profiled surfaces. Research has indicated that TRL rubber may provide a better indication of barefoot slip resistance due to the softer yielding nature of the material, being more comparable to human skin than Four S rubber.

UNE ENV 12633

Prova del pendolo secondo la normativa UNE ENV 12633

CLASSIFICAZIONE DEI PAVIMENTI:

Scivolosità (R _d)	Classe
R _d ≤ 15	0
15 < R _d ≤ 35	1
35 < R _d ≤ 45	2
R _d > 45	3

Classe attribuibile alle pavimentazioni in funzione della loro collocazione

Collocazione e caratteristiche della pavimentazione

Classe	Classe
1	1
2	2

Zone interne asciutte, come gli ingressi agli edifici da spazi esterni(1), terrazze coperte, guardaroba, docce, bagni, spogliatoi, cucine, etc.

- superfici con pendenza minore del 6%

- superfici con pendenza maggiore o uguale al 6% e scale

Zone interne umide, come gli ingressi agli edifici da spazi esterni(1), terrazze coperte, guardaroba, docce, bagni, spogliatoi, cucine, etc.

- superfici con pendenza minore del 6%

- superfici con pendenza maggiore o uguale al 6% e scale

Zone interne dove, oltre l'acqua, si possono trovare agenti (grassi, lubrificanti, etc.) che riducono la resistenza allo scivolamento, come cucine industriali, macelli, parcheggi, zone di uso industriale, ecc.

Zone esterne. Piscine (2)

(1) Fanno eccezione gli accessi diretti a zone di uso limitato.

(2) In zone dove si prevede il passaggio di utenti scalzi e sul fondo delle vasche nella zona in cui la profondità non ecceda 1,50 m.

Pendulum test according to the UNE ENV 12633 standard

CLASSIFICATION OF FLOORS:

Slip resistance coefficient (R _d)	Class
R _d ≤ 15	0
15 < R _d ≤ 35	1
35 < R _d ≤ 45	2
R _d > 45	3

Class required for floors accordingto their location

Location and characteristics of the floor

Class	Class
1	1
2	2

Dry interior areas

- surfaces with a slope less than 6%

- surfaces with a slope equal to or greater than 6% and stairs

Humid interior areas, such as entrances to buildings from the exterior (1), covered terraces, changing rooms, showers, baths, toilets, kitchens, etc.

- surfaces with a slope less than 6%

- surfaces with a slope equal to or greater than 6% and stairs

Interior areas, which in addition to water, may include agents (greases, lubricants, etc.) that may reduce slip resistance, such as industrial kitchens, slaughterhouses, parking lots, industrial use areas, etc.

Exterior areas. Swimming pools (2)

(1) Except in the case of direct entries to areas of restricted use.

(2) In areas provided for barefoot users and in the bottom of pools, in areas in which the depth does not exceed 1.5 m.

Ensayo del péndulo según la norma UNE ENV 12633

CLASIFICACION DE LOS SUELOS:

Resistencia al deslizamiento (R _d)	Clase
R _d ≤ 15	0
15 < R _d ≤ 35	1
35 < R _d ≤ 45	2
R _d > 45	3

Clase exigible a los suelos en función de su localización

Localización y características del suelo

Clase	Clase
1	1
2	2

Zonas interiores secas

- superficies con pendiente menor que el 6%

- superficies con pendiente igual o mayor que el 6% y escaleras

Zonas interiores húmedas, tales como las entradas a los edificios desde el espacio exterior (1), terrazas cubiertas, vestuarios, duchas, baños, aseos, cocinas, etc.

- superficies con pendiente menor que el 6%

- superficies con pendiente igual o mayor que el 6% y escaleras

Zonas interiores donde, además de agua, pueda haber agentes (grasas, lubricantes, etc.) que reduzcan la resistencia al deslizamiento, tales como cocinas industriales, mataderos, aparcamientos, zonas de uso industrial, etc.

Zonas exteriores. Piscinas (2)

(1) Excepto cuando se trate de accesos directos a zonas de uso restringido.

(2) En zonas previstas para usuarios descalzos y en el fondo de los vasos, en las zonas en las que la profundidad no exceda de 1,50 m.

CARATTERISTICHE TECNICHE

TECHNICAL CHARACTERISTICS | CARACTÉRISTIQUES TECHNIQUES | TECHNISCHE EIGENSCHAFTEN



CARRABILITÀ

TRANSITABLE | PRATICABLE | BEFAHRBARE

EN 1339

Le lastre per strade e coperture in cemento sono soggetti a marcatura NF, la cui gestione è garantita da CERIB su incarico di AFNOR Certification.

• Classi di denominazione NF riconducibili all'uso

Corrispondono alle classi di requisiti della norma P 98-335 in merito al dimensionamento e alla realizzazione di pavimentazioni.

Les dalles de voirie et de toiture en béton font l'objet d'une marque NF dont la gestion est assurée par le CERIB par mandat de l'AFNOR Certification.

• Les classes d'appellation NF liées à l'usage

Elles correspondent aux classes d'exigences de la norme P 98-335 concernant le dimensionnement et la mise en oeuvre des chaussées.

Classe		S4	T7	T11	U14	U25	U30	
Destinazione STRADA & COPERTURE Destination VOIRIE & TOITURE	Posa su sabbia o malta Pose sur sable ou mortier	Veicoli con carico per ruota < 0,6 t Véhicules de charge par roue < 0,6 t	Veicoli con carico per ruota < 0,9 t Véhicules de charge par roue < 0,9 t	Veicoli con carico per ruota < 2,5 t Véhicules de charge par roue < 2,5 t	Circolazione occasionale e a bassa velocità Circulation occasionnelle et à vitesse réduite	Circolazione normale Circulation normale	Circolazione occasionale et à vitesse réduite Circulation occasionnelle et à vitesse réduite	Circolazione normale Circulation normale
	Posa su sostegni Pose sur plots	/	Solo accesso pedonale Accès piétons exclusivement	Veicoli con carico per ruota < 0,9 t in circolazione a velocità ridotta e per 40 veicoli/giorno/direzione al massimo (parcheggio, ...) Véhicules de charge par roue < 0,9 t circulant à vitesse réduite et à raison de 40 véhicules/jour/sens au maximum (aires de stationnement, ...)	Uso collettivo o pubblico Usage collectif ou public	/	/	/

Nota che la designazione di tali classi è conforme alla norma europea che prevede una lettera per la resistenza alla flessione e un numero per il carico di rottura, pertanto per U25: U corrisponde a una resistenza alla flessione di 5,0 MPa e 25 a un carico di rottura di 25 kN.

A noter que l'appellation de ces classes est conforme à la norme européenne qui prévoit une lettre pour la résistance à la flexion et un nombre pour la charge de rupture ainsi pour U25: U correspond à une résistance à la flexion de 5,0 MPa et 25 à une charge de rupture de 25 kN.



CARICO DI ROTTURA (S)

BREAKING STRENGTH (S) | CHARGE DE RUPTURE (S) | BRUCHLAST (S)

ISO 10545-4

Questo parametro serve per valutare la capacità della mattonella di sopportare carichi statici e dinamici quando è posta in esercizio. La norma considera la piastrella come una trave, posta su due rulli distanti tra loro, mentre al centro viene applicata una forza tramite un terzo rullo.

Il carico di rottura è il peso che viene sopportato prima della rottura della mattonella. Il carico di rottura effettivo della mattonella in opera è notevolmente superiore a quello misurato in laboratorio.

This parameter is used to assess the ceramic tile's capacity to withstand static and dynamic loads after laying. The standard considers the tile as a beam, placed on two rollers some distance apart, while a third roller applies a force to its centre. The breaking strength is the weight the tile withstands before breaking. The actual breaking strength of a tile after laying is considerably higher than the value measured in the laboratory.

Ce paramètre permet d'évaluer la capacité qu'a le carreau de supporter des charges statiques et dynamiques. La norme considère le carreau comme une poutre posée sur deux rouleaux distants l'un de l'autre alors qu'au centre du carreau est appliquée une force par l'intermédiaire d'un troisième rouleau. La charge de rupture est le poids supporté avant rupture du carreau. La charge de rupture effective du carreau après pose est très nettement supérieure à celle mesurée en laboratoire.

Dieser Parameter dient zur Bewertung der Fliesenfähigkeit, im verlegten Zustand statischen und dynamischen Lasten standzuhalten. Die Norm bestimmt, dass die Fliese wie ein Balken auf zwei voneinander distanziernten a aufliegt und in der Mitte durch eine dritte Rolle eine Kraft auf sie aufgebracht wird. Die Bruchfestigkeit ist das Gewicht, das vor dem Fliesenbruch ertragen wird. Die effektive Bruchfestigkeit der verlegten Fliese ist wesentlich höher als die im Labor gemessene Bruch-festigkeit.

ASTM C 648

Il metodo di prova consiste nell'appoggiare la piastrella sulle estremità di tre aste cilindriche oppure su tre cuscinetti a sfera per piastrelle, aventi un'area facciale pari a 6,25 pollici² (40 cm²) o area minore, disposte/i in modo da formare un triangolo equilatero. È pertanto applicata una forza di entità prestabilita al centro del supporto triangolare. Tale forza è mantenuta fino alla rottura del campione.

The test method consists of supporting the tile on the ends of three cylindrical rods, or on three ball bearings for tiles having a facial area of 6.25 in² (40 cm²) or less, arranged in an equilateral triangle, and applying force at a definite rate to the centre of the triangular support, until the specimen breaks.

La méthode d'essai consiste à appuyer le carreau sur les extrémités de trois tiges cylindriques ou sur trois roulements à billes pour carreaux ayant une surface faciale de 6,25 pouces² (40 cm²) ou inférieure, disposées/és de façon à former un triangle équilatéral. L'essai prévoit ensuite l'application d'une force prédéterminée au centre du support triangulaire, jusqu'à la rupture de l'échantillon.

Die Testmethode besteht darin, die Fliese auf die Extremitäten von drei Zylinderstangen abzulegen, bzw. auf drei Fliesenkugellagern, mit einer Frontfläche von 6,25 Zoll² (40 cm²) oder weniger, die in ihrer Anordnung ein gleichseitiges Dreieck bilden. Dann wird in der Mitte dieses dreieckigen Trägers eine Kraft mit zuvor festgelegtem Ausmaß ausgeübt, bis die Probe bricht.

GRADO DI STONALIZZAZIONE

SHADE VARIATION | DEGRÉ DE VARIABILITÉ CHROMATIQUE | ABTÖNUNGSGRAD

ANSI A137.1 (14mm - 20mm) - ANSI A137.3 (KERLITE)

Classificazione estetica e variazioni di tono. Il colore, la struttura e l'aspetto delle piastrelle possono variare secondo le specifiche del produttore definite per la particolare serie di piastrelle o linea di prodotto. Le seguenti designazioni di "classe estetica" sono fornite nella Tabella, affinché il produttore possa comunicare le caratteristiche estetiche di un particolare prodotto.

Aesthetic classification and shade variations. Tiles may vary in color, texture, or appearance according to the manufacturer's design for that particular tile series or product line. The following aesthetic class designations have been provided in the Table, so that the manufacturer may communicate the aesthetic characteristics of a particular tile product.

Classification esthétique et variations de tonalité. La couleur, la structure et l'aspect des carreaux peuvent varier en fonction des spécifications du producteur définies pour la série de carreaux ou la ligne de produit spécifique. Les désignations de « classe esthétique » suivantes sont fournies dans le Tableau pour permettre au producteur de communiquer les caractéristiques esthétiques d'un produit particulier.

Ästhetische Klassifikation und Variationen des Farbtons. Die Farbe, die Struktur und das Aussehen der Fliesen können auf Grund der für die besondere Fliesenserie oder Produktreihe festgelegten Spezifikationen des Herstellers variieren. Die folgenden Bestimmungen der „ästhetischen Kategorie“ finden sich in Tabelle, damit der Hersteller die ästhetischen Charakteristiken eines besonderen Produkts mitteilen kann.



V0

NULLA

Aspetto molto uniforme. I pezzi della stessa variante di colore sono molto uniformi.

NONE

Very uniform appearance. Pieces of the same shade value are very uniform.

NUL

Aspect très uniforme. Les pièces de la même variante de couleur sont très uniformes.

GLEICH NULL

Sehr gleichmäßiges Aussehen. Die Teile der gleichen Farbvariante sind sehr gleichmäßig.



V1

LIEVE

Aspetto uniforme. Le differenze fra i pezzi di un lotto di produzione sono minime.

MINOR

Uniform appearance. Differences among pieces from the same production run are minimal.

LÉGER

Aspect uniforme. Les différences entre les pièces d'un même lot de production sont minimales.

LEICHT

Gleichmäßiges Aussehen. Die Unterschiede zwischen den Teilen eines Produktionsloses sind minimal.



V2

BASSO

Variazioni minime. Differenze chiaramente visibili nella struttura e/o nel design fra pezzi di colori simili.

LOW

Slight variation. Clearly distinguishable differences in texture and/or pattern within similar colors.

FAIBLE

Variations minimes. Différences clairement visibles au niveau de la structure et/ou du design entre les pièces caractérisées par des couleurs analogues.

GERING

Minimale Variationen. Deutlich sichtbare Unterschiede in der Struktur und/oder im Design zwischen Teilen ähnlicher Farbe.



V3

MEDIO

Variazioni moderate. Benché i colori e la struttura di un singolo pezzo possano essere identificativi dei colori e della struttura degli altri pezzi, la variazione di colore e di struttura di ciascun pezzo può variare in maniera significativa. Si consiglia di esaminare la gamma prima dell'eventuale scelta.

MEDIUM

Moderate variation. While the colors and or texture present on a single piece of tile will be indicative of the colors and or texture to be expected on the other tiles, the amount of colors and or texture on each piece may vary significantly. It is recommended that the range be viewed before selection.

MOYEN

Variations modérées. Même si les couleurs et la structure d'une seule pièce peuvent identifier les couleurs et les structures des autres pièces, la variation de la couleur et de la structure de chaque pièce peut être significative. Il est conseillé d'examiner la gamme avant de choisir.

MITTELMÄßIG

Mäßige Variationen. Obwohl die Farben und die Struktur eines einzelnen Teils kennzeichnend für die Farben und die Struktur der andern Teile sein können, können die Farbe und die Struktur der einzelnen Teile signifikante Variationen aufweisen. Vor der eventuellen Wahl ist es ratsam das Produktspektrum zu prüfen.



V4

ALTO

Variazioni sostanziali. Differenze casuali di colore o struttura da piastrella e piastrella, di conseguenza una piastrella può avere colori e/o struttura totalmente diversi da altre piastrelle. Pertanto, il risultato finale sarà unico e non ripetibile. Si consiglia di esaminare la gamma prima dell'eventuale scelta.

MAJOR

Substantial variation. Random color and or texture differences from tile to tile, so that one tile may have totally different colors and or texture from that on other tiles. Thus, the final installation will be unique. It is recommended that the range be viewed before selection.

ÉLEVÉ

Variations importantes. Différences casuelles au niveau de la couleur ou de la structure d'un carreau à l'autre. Un carreau peut ainsi présenter des couleurs et/ou une structure totalement différentes de celles d'autres carreaux. Le résultat final sera donc unique et non reproductible. Il est conseillé d'examiner la gamme avant de choisir.

STARCK

Wesentliche Variationen. Zufällige Farb- oder Strukturunterschiede der einzelnen Fliesen, in der Folge können sich Farben und/oder Struktur voll-kommen von den andern Fliesen unterscheiden. Deshalb ist das Endergebnis einmalig und unwiederholbar. Vor der eventuellen Wahl ist es ratsam das Produktspektrum zu prüfen.

CARATTERISTICHE TECNICHE 14MM-20MM | 1/2

TECHNICAL CHARACTERISTICS | CARACTÉRISTIQUES TECHNIQUES | TECHNISCHE EIGENSCHAFTEN

<p>Conforme According to Conforme Gemäß: ISO 13006-G (Gruppo Bla) EN 14411-G (Gruppo Bla) ANSI A137.1 (Porcelain tiles - P1 Class)</p>	<p>RESISTENZA ALLO SCIVOLAMENTO SLIP RESISTANCE RÉSISTANCE AU GLISSEMENT RUTSCHFESTIGKEIT</p>							<p>CARRABILITÀ Valore medio TRANSITABILITY Average value PRATICABILITÀ Valeur moyenne BEFAHRBARKEIT Durchschnittswert **</p>
	DIN 51130	DIN 51097	ANSI A326.3	BCR TORTUS	AS/NZS 4586	UNE ENV 12633	BS 7976-2	EN 1339

<p>14mm Gres porcellanato spessorato Extra thick porcelain stoneware Grès cérame à épaisseur majorée Extra-Dickes Feinsteinzeug</p>	<p>Spessore 14 mm Thickness Épaisseur Dickses</p>							
	<p>BUXY (Bla UGL) Nat Rett./Lux Rett. Flammè Nat Rett./ Lux Rett.</p>	<p>R9 R12 Nat Rett. R10 Lux Rett.</p>	<p>C (A+B+C) Nat Rett.</p>	<p>DCOF ≥ 0,42</p>	<p>μ > 0,40 Nat Rett. Flammè Nat Rett.</p>	<p>P4 Nat Rett.</p>	<p>Classe 3 Nat Rett. Classe 2 Lux Rett.</p>	
<p>CADORE (Bla UGL) Rett.</p>	<p>R10</p>	<p>B (A+B)</p>	<p>DCOF ≥ 0,42</p>	<p>μ > 0,40</p>		<p>Classe 3</p>		
<p>CASALI (Bla GL) Rett.</p>	<p>R9</p>							
<p>CEMENT PROJECT (Bla UGL) Land Naturale Rett. Land Lappata Rett.</p>	<p>R10 Naturale Rett.</p>	<p>B (A+B) Naturale Rett.</p>	<p>DCOF ≥ 0,42</p>	<p>μ > 0,40 Naturale Rett.</p>	<p>P3 Naturale Rett.</p>	<p>Classe 1 Naturale Rett.</p>	<p>PTV 36+ Wet 45 (Slider 96) Naturale Rett.</p>	
<p>CLUNY (Bla UGL) Sablé Rett. - Adouci Rett. Layé Rett.</p>	<p>R10 Sablé Rett.</p>	<p>B (A+B) Sablé Rett.</p>	<p>DCOF ≥ 0,42 Sablé Rett. Adouci Rett.</p>	<p>μ > 0,40 Sablé Rett.</p>	<p>P3 Sablé Rett.</p>	<p>Classe 2 Sablé Rett.</p>	<p>PTV 36+ Wet 45 (Slider 96) Sablé Rett.</p>	
<p>EXEDRA (Bla UGL) Silk Rett. Glossy Rett.*</p>			<p>DCOF ≥ 0,42</p>			<p>Classe 1</p>		
<p>LIMESTONE (Bla UGL) Natural Rett. - Blazed Rett. Honed Rett.</p>	<p>R11 Blazed Rett. R10 Natural Rett.</p>	<p>C (A+B+C) Blazed Rett. B (A+B) Natural Rett.</p>	<p>DCOF ≥ 0,42 Natural Rett. Blazed Rett.</p>	<p>μ > 0,40 Natural Rett. Blazed Rett.</p>	<p>P3 Natural Rett.</p>	<p>Classe 3 Blazed Rett. Classe 1 Natural Rett.</p>	<p>PTV 36+ Wet 45 (Slider 96) Natural Rett.</p>	
<p>SECRET STONE (Bla UGL) Natural Rett. - Honed Rett. Grip Rett.</p>	<p>R11 Grip Rett. R10 Natural Rett.</p>	<p>C (A+B+C) Grip Rett. B (A+B) Natural Rett.</p>	<p>DCOF ≥ 0,42</p>	<p>μ > 0,40</p>		<p>Classe 1 - Honed Rett. Classe 2 - Natural Rett. Classe 3 - Grip Rett.</p>	<p>PTV 36+ Wet 45 (Slider 96) Natural Rett.</p>	
<p>STONEQUARTZ (Bla UGL) Fiammata Rett.</p>	<p>R11</p>	<p>B (A+B)</p>	<p>DCOF ≥ 0,42</p>	<p>μ > 0,40</p>		<p>Classe 2</p>		
<p>X-BETON (Bla UGL) Naturale Rett. Satinata Rett.</p>	<p>R11 Naturale Rett. R10 Satinata Rett.</p>	<p>C (A+B+C)</p>			<p>P4 Naturale Rett.</p>	<p>Classe 3 - Naturale Rett. Classe 2 - Satinata Rett.</p>	<p>PTV 36+ Wet 45 (Slider 96) Naturale Rett.</p>	

<p>20mm Gres porcellanato superspessorato Ultra thick porcelain stoneware Grès cérame à épaisseur fortement majorée Super-Dickes Feinsteinzeug</p>	<p>Spessore 20 mm Thickness Épaisseur Dickses</p>							
	<p>BLUESTONE EVOLUTION (Bla UGL) Rockstone Rett.</p>	<p>R11</p>				<p>P4</p>	<p>Classe 3</p>	<p>T11-U11</p>
<p>CADORE (Bla UGL) Naturale Rett.</p>	<p>R11</p>					<p>Classe 2</p>		
<p>CEMENT PROJECT (Bla UGL) Work Rett.</p>	<p>R12</p>							
<p>CLUNY (Bla UGL) Layé Rett.</p>	<p>R11</p>	<p>C (A+B+C)</p>	<p>DCOF ≥ 0,42</p>	<p>μ > 0,40</p>		<p>Classe 3</p>	<p>T11-U11</p>	
<p>LIMESTONE (Bla UGL) Fiammata Rett.</p>					<p>P4</p>			
<p>PIETRA D'ISEO (Bla UGL) Naturale Rett.</p>	<p>R12</p>							
<p>SECRET STONE (Bla UGL) Bocciardata Rett.</p>	<p>R11</p>				<p>P4</p>	<p>Classe 2</p>		
<p>STONEQUARTZ (Bla UGL) Fiammata Rett.</p>								
<p>X-BETON (Bla UGL) Fiammata Rett.</p>	<p>R11</p>							

*La presenza sporadica di piccole disuniformità o di puntini sulla superficie è da ritenere caratteristica del materiale e della sua particolare lavorazione. Consigliato per pavimenti in ambienti residenziali.
 The sporadic presence of small non-uniformities or dots on the surface is to be considered characteristic of the material and of its finishing. Recommended for residential floors.
 La présence sporadique de petites non-uniformités ou de petits points sur la surface sont une caractéristique du produit et de son traitement particulier. Conseillé pour les sols dans les environnements résidentiels.
 Das vereinzelte Vorkommen von kleinen Ungleichmäßigkeiten oder Pünktchen auf der Oberfläche ist als charakteristisch für das Material und dessen spezielle Bearbeitung zu betrachten. Empfohlen für Böden in Wohngebenden.

<p>STONALIZZAZIONE SHADE VARIATION DÉNUANCEMENT ENTTONALISIERUNG</p>	<p>RESISTENZA ALLE MACCHIE STAIN RESISTANCE RÉSISTANCE AUX TACHES FLECKENBESTÄNDIGKEIT</p>	<p>RESISTENZA ALL'USURA DA CALPESTIO Valore medio RESISTANCE TO TRAMPLING WEAR Average value RÉSISTANCE À L'USURE DUE AU PIETINEMENT Valeur moyenne ABRIEFESTIGKEIT Durchschnittswert</p>	<p>RESISTENZA ALLA ABRASIONE PROFONDA Valore medio DEEP ABRASION RESISTANCE Average value RÉSISTANCE À L'ABRASION PROFONDE Valeur moyenne WIDERSTAND GEGEN TIEFENABRIEB Durchschnittswert</p>	<p>CARICO DI ROTTURA (S) Valore medio BREAKING STRENGTH (S) Average value CHARGE DE RUPTURE (S) Valeur moyenne BRUCHLAST (S) Durchschnittswert</p>	<p>RESISTENZA ALLA FLESSIONE Valore medio BENDING STRENGTH Average value RÉSISTANCE À LA FLEXION Valeur moyenne MECHANISCHER WIDERSTAND Durchschnittswert</p>	<p>RESISTENZA ALL'ATTACCO CHIMICO RESISTANCE TO CHEMICAL ETCHING Average value RÉSISTANCE À L'ATTAQUE CHIMIQUE Valeur moyenne BESTÄNDIGKEIT GEGEN CHEMIKALIEN ***</p>	<p>ASSORBIMENTO D'ACQUA Valore medio WATER ABSORPTION Average value ABSORPTION D'EAU Valeur moyenne WASSER-AUFNAHMEFÄHIGKEIT Durchschnittswert</p>	<p>RESISTENZA AL GELO FROST RESISTANCE RÉSISTANCE AU GEL FROSTBESTÄNDIGKEIT</p>	
ANSI A137.1	ASTM C 1378	ISO 10545-14	ASTM C 1027 ISO 10545-7	ASTM C 1243 ISO 10545-6	ASTM C 648 ISO 10545-4	ISO 10545-4	ASTM C 650 ISO 10545-13	ASTM C 373 ISO 10545-3	ASTM C 1026 ISO 10545-12

V2																					
V3																					
V4																					
V2	A RESISTENTE RESISTANT	5 RESISTENTE RESISTANT																			
V3 Art. Oslo V4 Nordic, Bergen																					
V3	A RESISTENTE RESISTANT	5 RESISTENTE RESISTANT																			





V2																					
V4																					
V2	A RESISTENTE RESISTANT	5 RESISTENTE RESISTANT																			
V3 Art. Oslo V4 Nordic, Bergen																					
V2																					

**Carrabile quando incollata su massetto. La classificazione si riferisce al solo formato quadrato.
 Transitabile when applied to a screed with adhesive. This information applies only to square formats.
 Praticable après collage sur chape. Cette information n'est valable que pour les formats carrés.
 Fahrbar bei Verkleben auf Estrich. Diese Information bezieht sich nur auf quadratische Formate.

***Ad esclusione dell'acido fluoridrico e derivati.
 Excluding hydrofluoric acid and derivatives.
 Non résistant à l'acide fluorhydrique et ses dérivés.
 Nicht widerstandsfähig gegen Fluorwasserstoffsäure und Derivate.





CARATTERISTICHE TECNICHE 14MM-20MM | 2/2

TECHNICAL CHARACTERISTICS | CARACTÉRISTIQUES TECHNIQUES | TECHNISCHE EIGENSCHAFTEN

		 DILATAZIONE TERMICA LINEARE LINEAR THERMAL EXPANSION DILATATION THERMIQUE LINÉAIRE THERMISCHE DILATATION		 REAZIONE AL FUOCO FIRE REACTION RÉACTION AU FEU FEUERREAKTION		 CONDUCIBILITÀ TERMICA THERMAL CONDUCTIVITY CONDUCTIBILITÉ THERMIQUE WÄRMELEITFÄHIGKEIT		PROTECT ANTIBATTERICO - ANTIMICROBIAL SUPERFICIE ANTIBATTERICA ANTIMICROBIAL SURFACE SURFACE ANTIBACTÉRIENNE ANTIBAKTERIELLEN OBERFLÄCHEN		INFORMAZIONI SULLA PULIZIA INFORMATION ABOUT CLEANING INFORMATIONS SUR LE NETTOYAGE INFORMATIONEN ZUR REINIGUNG	
Conforme According to Conforme Gemäß: ISO 13006-G (Gruppo B1a) EN 14411-G (Gruppo B1a) ANSI A137.1 (Porcelain tiles - P1 Class)		ISO 10545-8	ASTM C 372	EN 13823	EN 9239-1	FLAME SPREAD ASTM E84	EN 12524		 VISIBILITÀ DELLE IMPRONTE Metodo Cotto d'Este TREAD MARK VISIBILITY Cotto d'Este method VISIBILITÉ DES EMPREINTES Méthode Cotto d'Este SICHTBARKEIT VON FUßSPUREN Cotto d'Este Verfahren	 FACILITÀ DI PULIZIA Metodo Cotto d'Este CLEANING EASINESS Cotto d'Este method FACILITÉ D'ÉLIMINATION DE LA TACHE Méthode Cotto d'Este SICHTBARKEIT VON FUßSPUREN Cotto d'Este Verfahren	
14mm Gres porcellanato spessorato Extra thick porcelain stoneware Grès cérame à épaisseur majorée Extra-Dickes Feinsteinzeug		Spessore 14 mm Thickness Épaisseur Dickes									
BLUESTONE EVOLUTION	Rockstone Rett.	$\alpha \leq 7 \times 10^{-6} \text{ } ^\circ\text{C}^{-1}$	$\alpha \leq 4,4 \times 10^{-6} \text{ } ^\circ\text{F}^{-1} / \alpha \leq 8 \times 10^{-6} \text{ } ^\circ\text{C}^{-1}$	Classe - Class A1 (WALL)	Classe - Class A1_r (FLOOR)	Class A	$\lambda = 1.3 \text{ W/m}^2\text{K} / 0.7 \text{ Btu} / \text{ft}^2\text{h}^\circ\text{F}$	●	B	2	
BUXY	Nat Rett./Lux Rett.								A	1	
	Nat Flammé/Lux Flammé Rett.								B	2/1	
CADORE	Rett.								●	A Baita, Bosco, Malga - B Alpe	1
CASALI									A		
CEMENT PROJECT	Land Naturale Rett. Land Lappata Rett.								●	A Land Lappata - B Land Naturale	2
CLUNY	Sablé Rett. - Adouci Rett.								●	B	1 Bourgogne 2 Ardenne, Argerot, Champagne
	Layé Rett.										
ELEGANCE	Nat Rett.									A	1
EXEDRA	Silk Rett. Glossy Rett.								●	B	2
LIMESTONE	Natural Rett. - Blazed Rett. Honed Rett.								●	A HONED B NATURAL, BLAZED	1 HONED 2 NATURAL, BLAZED
SECRET STONE	Natural Rett. - Honed Rett. Grip Rett.								●	A HONED B NATURAL, GRIP	2
STONEQUARTZ	Fiammata Rett.								●	B	
X-BETON	Naturale Rett. Satinata Rett.								●	A SATINATA B NATURALE	
20mm Gres porcellanato superspessorato Ultra thick porcelain stoneware Grès cérame à épaisseur fortement majorée Super-Dickes Feinsteinzeug		Spessore 20 mm Thickness Épaisseur Dickes									
BLUESTONE EVOLUTION	Rockstone Rett.	$\alpha \leq 7 \times 10^{-6} \text{ } ^\circ\text{C}^{-1}$	$\alpha \leq 4,4 \times 10^{-6} \text{ } ^\circ\text{F}^{-1} / \alpha \leq 8 \times 10^{-6} \text{ } ^\circ\text{C}^{-1}$	Classe - Class A1 (WALL)	Classe - Class A1_r (FLOOR)	Class A	$\lambda = 1.3 \text{ W/m}^2\text{K} / 0.7 \text{ Btu} / \text{ft}^2\text{h}^\circ\text{F}$		B	2	
CADORE	Naturale Rett.										
CEMENT PROJECT	Work Rett.										
CLUNY	Layé Rett.										
LIMESTONE	Fiammata Rett.										
PIETRA D'ISEO	Naturale Rett.										
SECRET STONE	Bocciardata Rett.										
STONEQUARTZ	Fiammata Rett.										
X BETON	Fiammata Rett.										

CARATTERISTICHE TECNICHE KERLITE 1/2

TECHNICAL CHARACTERISTICS | CARACTÉRISTIQUES TECHNIQUES | TECHNISCHE EIGENSCHAFTEN

		 RESISTENZA ALLO SCIVOLAMENTO SLIP RESISTANCE RÉSISTANCE AU GLISSEMENT RUTSCHFESTIGKEIT					
Conforme According to Conforme Gemäß: ISO 13006-G (Gruppo Bla) EN 14411-G (Gruppo Bla) ANSI A137.3 (Back layered gauged porcelain slabs)		DIN 51130	DIN 51097	ANSI A326.3	BCR TORTUS	UNE ENV 12633	BS 7976-2
 Gres porcellanato laminato Laminated porcelain stoneware Grès cérame laminé Laminiertes Feinsteinzeug		Spessore 3,5 mm Thickness Épaisseur Dickses					
BLACK-WHITE (Bla UGL)	Naturale						
BUXY (Bla UGL)		R10				Class 1	
CLUNY (Bla UGL)	Naturale	R9		DCOF ≥ 0.42	μ > 0,40	Class 1	
OVER (Bla UGL)	Naturale						
	Soft ¹						
WONDERWALL (Bla UGL) ²	Matrix - Ritmi						
WONDERWALL (Bla GL) ³	Freestyle - Sketch - Lotus - Script Jungle - Frame - Zen Venice - Color Ballet - Dream						
 Gres porcellanato laminato Laminated porcelain stoneware Grès cérame laminé Laminiertes Feinsteinzeug		Spessore 5,5 mm Thickness Épaisseur Dickses					
BLACK-WHITE (Bla UGL)	Ultrawhite Glossy						
CEMENT PROJECT (Bla UGL)	Work - Cem	R9 Cem - R10 Work				Class 1 (Work)	
CLUNY (Bla UGL)	Layé	R10	B (A+B)	DCOF ≥ 0.42	μ > 0,40	Class 1	
ELEGANCE (Bla UGL)	Silk						
EXEDRA (Bla UGL)	Glossy						
	Silk						
FOREST (Bla UGL)		R10	B (A+B)	DCOF ≥ 0.42	μ > 0,40	Class 1	
LIMESTONE (Bla UGL)	Natural					Class 2	PTV 36+ Wet 4S (Slider 96)
MATERICA (Bla UGL)		R9					
METAL (Bla UGL)		R9 Corten, Iridium		DCOF ≥ 0.42 Corten, Iron	μ > 0,40 Corten		
 Gres porcellanato laminato Laminated porcelain stoneware Grès cérame laminé Laminiertes Feinsteinzeug		Spessore 6,5 mm Thickness Épaisseur Dickses					
PIETRA D'ISEO (Bla UGL)	Naturale	R10		DCOF ≥ 0.42	μ > 0,40	Class 1	
VANITY (Bla UGL)	Glossy/Touch						
WOODLAND (Bla UGL)	Soft/Wild	R9 Soft / R10 Wild	B (A+B) Wild	DCOF ≥ 0.42	μ > 0,40	Class 2	









¹ Ideale per rivestimenti e consigliato per pavimenti in ambienti residenziali. | Ideal for wall installation and recommended for floor installation in residential areas only. | Idéal pour le revêtement mur et proposé pour le revêtement sol uniquement dans des zones résidentielles. | Geeignet für Wandverlegung und empfohlen für Bodenverlegung nur im Wohnbereiche.

² Realizzato in primo fuoco con decorazione Ink-Jet in linea. Per informazioni approfondite vedi pag. 344-345 | Sintered and printed using ink-jet decorations. For more detailed information please see pages 344-345 | Réalisé en première cuisson avec décoration à jet d'encre en ligne. Pour en savoir plus, consultez la page 344-345 | Realisiert mit Erstbrennung und serienmäßiger Ink-Jet-Dekoration. Für nähere Informationen siehe Seite 344-345

³ Decorata mediante la nuova tecnologia di stampa digitale a freddo su supporto in Kerlite 3plus. Idonei esclusivamente per la posa a parete in ambienti interni; non posare a pavimento e a rivestimento in luoghi esterni. Per informazioni approfondite vedi pag. 344-345 | Decorated using a new cold digital printing technology on Kerlite 3plus. Intended exclusively for the cladding of interior walls; do not use as flooring or to clad exterior spaces. For more detailed information please see pages 344-345 | Décoré grâce à la nouvelle technologie d'impression numérique à froid sur support en Kerlite 3plus. Approprié pour la pose au mur à l'intérieur ou à l'extérieur et pour la pose au sol dans le domaine résidentiel et public. Pour en savoir plus, consultez la page 344-345 | Dekoriert mit der neuen Digitaldruck-Technologie auf Träger Kerlite 3plus. Geeignet für die Wandverlegung im Innen- und Außenbereich und für die Fußbodenverlegung im Wohn- und öffentlichem Bereich. Für nähere Informationen siehe Seite 344-345

⁴ Ad esclusione dell'acido fluoridrico e derivati. | Excluding hydrofluoric acid and derivatives. | Non résistant à l'acide fluorhydrique et ses dérivés. | Nicht widerstandsfähig gegen Fluorwasserstoffsäure und Derivate.

⁵ Valore riferito al materiale ceramico. | Average refers to ceramic material. | Valeur se référant au matériau céramique. | Der Wert bezieht sich auf das Keramikmaterial.

		 STONALIZZAZIONE DESHADING DÉNUANCEMENT ENTTONALISIERUNG		 RESISTENZA ALLE MACCHIE STAIN RESISTANCE RÉSISTANCE AUX TACHES FLECKENBESTÄNDIGKEIT		 RESISTENZA ALL'ATTACCO CHIMICO RESISTANCE TO CHEMICAL ETCHING RÉSISTANCE À L'ATTAQUE CHIMIQUE BESTÄNDIGKEIT GEGEN CHEMIKALIEN ***		 RESISTENZA ALLA ABRASIONE PROFONDA Valore medio DEEP ABRASION RESISTANCE Average value RÉSISTANCE À L'ABRASION PROFONDE Valeur moyenne WIDERSTAND GEGEN TIEFENABRIEB Durchschnittswert		 CARICO DI ROTTURA (S) Valore medio BREAKING STRENGTH (S) Average value CHARGE DE RUPTURE (S) Valeur moyenne BRUCHLAST (S) Durchschnittswert		 RESISTENZA ALLA FLESSIONE Valore medio BENDING STRENGTH Average value RÉSISTANCE À LA FLEXION Valeur moyenne MECHANISCHER WIDERSTAND Durchschnittswert		 ASSORBIMENTO D'ACQUA Valore medio WATER ABSORPTION Average value ABSORPTION D'EAU Valeur moyenne WASSER-AUFNAHMEFÄHIGKEIT Durchschnittswert		 RESISTENZA AL GELO FROST RESISTANCE RÉSISTANCE AU GEL FROSTBESTÄNDIGKEIT	
ANSI A137.3	ASTM C 1378	ISO 10545-14	ASTM C 650	ISO 10545-13	ASTM C 1243 ISO 10545-6	ASTM C 1505	ASTM C 1505	ISO 10545-14	ASTM C 373 ISO 10545-3	ASTM C 1026 ISO 10545-12							
V1	A RESISTENTE RESISTANT	5 RESISTENTE RESISTANT	A RESISTENTE RESISTANT	LA-HA RESISTENTE RESISTANT	175 mm ³	≥ 85 lbf	≥ 6.000 PSI	50 N/mm ²	0,1%	RESISTENTE RESISTANT							
V1	CLASS C	≥ 3															
V1	A RESISTENTE RESISTANT	5 RESISTENTE RESISTANT	CLASS C	LA-HB	**												
V1			CLASS C	LB-HB													
V2	CLASS C	≥ 3	CLASS C	LB-HB	175 mm ³	≥ 175 lbf	≥ 6.000 PSI	50 N/mm ²	0,1%	RESISTENTE RESISTANT							
V3 Acero, Noce V4 Cembro, Rovere																	
V2	A RESISTENTE RESISTANT	5 RESISTENTE RESISTANT	A RESISTENTE RESISTANT	LA-HA RESISTENTE RESISTANT													
V1																	
V1 Iridium V2 Iron V3 Corten																	
V2	CLASS C	5 RESISTENTE RESISTANT	A RESISTENTE RESISTANT	LA-HA RESISTENTE RESISTANT													
V2	CLASS C	≥ 3	CLASS C	LB-HB	175 mm ³	≥ 175 lbf	≥ 6.000 PSI	50 N/mm ²	0,1%	RESISTENTE RESISTANT							
V2 Soft/V3 Wild	CLASS C	5 RESISTENTE RESISTANT		LA-HA RESISTENTE RESISTANT													





* Resiste alle macchie di alimenti e bevande conforme alla classe 5. Non resiste alla tintura di iodio, blu di metilene, pennarello indelebile. | Class-5 resistance to food and beverage stains. Not resistant to iodine dye, methylene blue, or permanent marker. | Réside aux taches d'aliments et boissons conforme à la classe 5. Ne résiste pas à la teinture d'iode, bleu de méthylène, feutre indélébile. | Fleckenbeständig gegen Lebensmittel- und Getränkeflecken, konform mit Klasse 5 Nicht beständig gegen Jodfarben, Methylenblau, Permanentmarker.

** La decorazione di questi prodotti non ha una buona resistenza ai graffi di oggetti acuminati molto duri come ad esempio metallo, pietra, vetro e gres. Prestare la massima attenzione alla movimentazione durante le operazioni di posa evitando di urtare o strisciare utensili ed oggetti duri acuminati sulla superficie. | This product's decoration is not scratch resistant to hard, sharp objects such as metal, stone, glass, and stoneware. Be extremely careful when handling the product during installation, making sure not to bump or slide tools or other sharp objects against the surface. | La décoration de ces produits ne résiste pas bien aux rayures causées par les objets pointus et très durs tels que le métal, la pierre, le verre ou le grès, entre autres. Faire particulièrement attention à la manipulation au cours des opérations de pose, en évitant de heurter ou de faire glisser les outils et les objets durs et pointus sur la surface. | Die Dekoration dieser Produkte ist nicht sehr widerstandsfähig gegen Kratzer durch sehr harte spitze Gegenstände, zum Beispiel aus Metall, Stein, Glas und Feinsteinzeug. Fahren Sie bei der Handhabung der Platten während der Verlegung besonders vorsichtig fort und vermeiden Sie Stöße oder Kratzer auf der Oberfläche durch Werkzeuge oder andere harte Gegenstände.

*** Ad esclusione dell'acido fluoridrico e derivati. | Excluding hydrofluoric acid and derivatives. | Non résistant à l'acide fluorhydrique et ses dérivés. | Nicht widerstandsfähig gegen Fluorwasserstoffsäure und Derivate.





CARATTERISTICHE TECNICHE KERLITE | 2/2

TECHNICAL CHARACTERISTICS | CARACTÉRISTIQUES TECHNIQUES | TECHNISCHE EIGENSCHAFTEN

		 DILATAZIONE TERMICA LINEARE LINEAR THERMAL EXPANSION DILATATION THERMIQUE LINÉAIRE THERMISCHE DILATATION		 REAZIONE AL FUOCO FIRE REACTION RÉACTION AU FEU FEUERREAKTION			
Conforme According to Conforme Gemäß: ISO 13006-G (Gruppo B1a) EN 14411-G (Gruppo B1a) ANSI A137.3 (Back layered gauged porcelain slabs)		ISO 10545-8	ASTM C 372	EN 13823	EN 9239-1	FLAME SPREAD ASTM E84	
 Gres porcellanato laminato Laminated porcelain stoneware Grès cérame laminé Laminiertes Feinsteinzeug		Spessore 3,5 mm Thickness Épaisseur Dickes					
BLACK-WHITE		$\alpha \leq 7 \times 10^{-6} \text{ } ^\circ\text{C}^{-1}$	$\alpha \leq 4,4 \times 10^{-6} \text{ } ^\circ\text{F}^{-1} / \alpha \leq 8 \times 10^{-6} \text{ } ^\circ\text{C}^{-1}$	Classe - Class A2-s1, d0 (WALL)	Classe - Class A2 _{fl} -s1 (FLOOR)	Class A	
BUXY							
CLUNY	Naturale						
OVER	Naturale Soft*						
WONDERWALL²	Matrix - Ritmi						
WONDERWALL¹	Freestyle - Sketch - Lotus Script - Jungle Frame - Zen - Venice Color Ballet - Dream						
 Gres porcellanato laminato Laminated porcelain stoneware Grès cérame laminé Laminiertes Feinsteinzeug		Spessore 5,5 mm Thickness Épaisseur Dickes					
BLACK-WHITE	Glossy*** Silk**	$\alpha \leq 7 \times 10^{-6} \text{ } ^\circ\text{C}^{-1}$	$\alpha \leq 4,4 \times 10^{-6} \text{ } ^\circ\text{F}^{-1} / \alpha \leq 8 \times 10^{-6} \text{ } ^\circ\text{C}^{-1}$	Classe - Class A2-s1, d0 (WALL)	Classe - Class A2 _{fl} -s1 (FLOOR)	Class A	
CEMENT PROJECT	Work - Cem						
CLUNY	Layé						
ELEGANCE	Silk**						
EXEDRA	Glossy*** Silk**						
FOREST							
LIMESTONE	Natural						
MATERICA							
METAL							
PIETRA D'ISEO	Natural						
VANITY	Glossy/Touch	$\alpha \leq 7 \times 10^{-6} \text{ } ^\circ\text{C}^{-1}$	$\alpha \leq 4,4 \times 10^{-6} \text{ } ^\circ\text{F}^{-1} / \alpha \leq 8 \times 10^{-6} \text{ } ^\circ\text{C}^{-1}$	Classe - Class A2-s1, d0 (WALL)	Classe - Class A2 _{fl} -s1 (FLOOR)	Class A	
WOODLAND	Soft/Wild						

1 Decorata mediante la nuova tecnologia di stampa digitale a freddo su supporto in Kerlite 3plus. Idonei esclusivamente per la posa a parete in ambienti interni; non posare a pavimento e a rivestimento in luoghi esterni.
Per informazioni approfondite vedi pag. 344-345 | Decorated using a new cold digital printing technology on Kerlite 3plus. Intended exclusively for the cladding of interior walls; do not use as flooring or to clad exterior spaces. For more detailed information please see pages 344-345 | Décoré grâce à la nouvelle technologie d'impression numérique à froid sur support en Kerlite 3plus. Appropriate pour la pose au mur à l'intérieur ou à l'extérieur et pour la pose au sol dans le domaine résidentiel et public. Pour en savoir plus, consultez la page 344-345 | Dekoriert mit der neuen Digitaldruck-Technologie auf Träger Kerlite 3plus. Geeignet für die Wandverlegung im Innen- und Außenbereich und für die Fußbodenverlegung im Wohn- und öffentlichen Bereich. Für nähere Informationen siehe Seite 344-345

2 Realizzato in primo fuoco con decorazione Ink-Jet in linea. Per informazioni approfondite vedi pag. 344-345 | Sintered and printed using ink-jet decorations. For more detailed information please see pages 344-345 | Réalisé en première cuisson avec décoration à jet d'encre en ligne. Pour en savoir plus, consultez la page 344-345 | Realisiert mit Erstbrennung und serienmäßiger Ink-Jet-Dekoration. Für nähere Informationen siehe Seite 344-345

		INFORMAZIONI SULLA PULIZIA INFORMATION ABOUT CLEANING INFORMATIONS SUR LE NETTOYAGE INFORMATIONEN ZUR REINIGUNG			
 CONDUCIBILITÀ TERMICA THERMAL CONDUCTIVITY CONDUCTIBILITÉ THERMIQUE WÄRMELEITFÄHIGKEIT	PROTECT ANTIBATTERICO - ANTIMICROBIAL SUPERFICIE ANTIBATTERICA ANTIMICROBIAL SURFACE SURFACE ANTIBACTÉRIENNE ANTIBAKTERIELLEN OBERFLÄCHEN	 VISIBILITÀ DELLE IMPRONTE Metodo Cotto d'Este TREAD MARK VISIBILITY Cotto d'Este method VISIBILITÉ DES EMPREINTES Méthode Cotto d'Este SICHTBARKEIT VON FUßSPUREN Cotto d'Este Verfahren	 FACILITÀ DI PULIZIA Metodo Cotto d'Este CLEANING EASINESS Cotto d'Este method FACILITÉ D'ÉLIMINATION DE LA TACHE Méthode Cotto d'Este SICHTBARKEIT VON FUßSPUREN Cotto d'Este Verfahren		
EN 12524					
		Utilizzare acqua o detersivi o sgrassatori neutri generici in vendita nei comuni negozi. Non utilizzare alcool, acetone e solventi in genere. Use water or generic neutral detergents or degreasers available over the counter in general stores. Do not use alcohol, acetone, or solvents in general. Utiliser de l'eau ou des détergents et dégraissants neutres génériques en vente dans les magasins. Ne pas utiliser d'alcool, acétone et solvants en poudre. Verwenden Sie Wasser oder neutrale im Handel erhältliche Reinigungs- bzw. Entfettungsmittel. Kein Alkohol, Aceton oder Lösungsmittel im Allgemeinen verwenden.			
 Gres porcellanato laminato Laminated porcelain stoneware Grès cérame laminé Laminiertes Feinsteinzeug	Spessore 5,5 mm Thickness Épaisseur Dickes	$\lambda = 1.3 \text{ W/m}^2\text{K} / 0.7 \text{ Btu} / \text{ft}^2\text{h}^{\circ}\text{F}$	●	B	2
			●	B	2
			●	A Cem B Work	1 Cem 2 Work
			●	B	2
			●	B	2
			●	B	2
			●	A Noce, Cembro B Acero, Rovere	1 Noce, Cembro 2 Acero, Rovere
			●	B	2
			●	B Cemento, Ardesia C Bianco, Avorio, Tortora	
			●	A Iron, Iridium B Corten	1 Iron, Iridium 2 Corten
 Gres porcellanato laminato Laminated porcelain stoneware Grès cérame laminé Laminiertes Feinsteinzeug	Spessore 6,5 mm Thickness Épaisseur Dickes	$\lambda = 1.3 \text{ W/m}^2\text{K} / 0.7 \text{ Btu} / \text{ft}^2\text{h}^{\circ}\text{F}$	●	A	1
			●	B	2
			●	A	1





*** Ideale per rivestimenti e consigliato per pavimenti in ambienti residenziali.** | Ideal for wall installation and recommended for floor installation in residential areas only. | Idéal pour le revêtement mur et proposé pour le revêtement sol uniquement dans des zones résidentielles. | Geeignet für Wandverlegung und empfohlen für Bodenverlegung nur im Wohnbereich.

**** Ideale per rivestimenti e consigliato per pavimenti in ambienti residenziali e commerciale leggero (vedi tabella pag. 312).** | Ideal for wall installation and recommended for flooring in residential and low-traffic commercial spaces (see table on pg. 312). | Idéal pour le revêtement mur et recommandé pour les sols dans des espaces résidentiels et commerciaux (petits). (Voir le tableau p. 312). | Geeignet für Wandverlegung und empfohlen für Fußböden in Wohnbereichen und leichte gewerbliche Nutzung (siehe Tabelle Seite 312).

***** La presenza sporadica di piccole disuniformità o di puntini sulla superficie è da ritenere caratteristica del materiale e della sua particolare lavorazione. Ideale per rivestimenti e consigliato per pavimenti in ambienti residenziali (vedi tabella pag. 312).** | The sporadic presence of small non-uniformities or dots on the surface is to be considered characteristic of the material and of its finishing. Ideal for wall installation and recommended for floor installation in residential areas only (see table on pg. 312). | La présence sporadique de petites non-uniformités ou de petits points sur la surface sont une caractéristique du produit et de son traitement particulier. Idéal pour le revêtement mur et proposé pour le revêtement sol uniquement dans des zones résidentielles (Voir le tableau p. 312). | Das vereinzelte Vorkommen von kleinen Ungleichmäßigkeiten oder Pünktchen auf der Oberfläche ist als charakteristisch für das Material und dessen spezielle Bearbeitung zu betrachten. Geeignet für Wandverlegung und empfohlen für Bodenverlegung nur im Wohnbereich (siehe Tabelle Seite 312).

FORMATI

SIZES | FORMATS | FORMATE

					
cm	100x300	33x300	120x260	100x250	30x240
inches	39"x118"	13"x118"	48"x102"	39"x98 1/2"	12"x96"

K-rite Gres porcellanato laminato / Laminated porcelain stoneware / Grès cérame laminé / Laminiertes Feinsteinzeug
 Spessore 3,5 mm / Thickness 3,5 mm / Épaisseur 3,5 mm / Dicke 3,5 mm









BLACK-WHITE		•			
BUXY		•			
CLUNY	Naturale	•			
OVER	Naturale	•			
	Soft	•			
WONDERWALL		•			

K-rite Gres porcellanato laminato / Laminated porcelain stoneware / Grès cérame laminé / Laminiertes Feinsteinzeug
 Spessore 5,5 mm / Thickness 5,5 mm / Épaisseur 5,5 mm / Dicke 5,5 mm

BLACK-WHITE	Glossy - Silk	•			
CEMENT PROJECT	Work - Cem	•			
CLUNY	Layé	•			
ELEGANCE	Silk	•			
EXEDRA	Glossy	•		•	
	Silk	•		•	
FOREST		•	•		
LIMESTONE	Natural	•		•	
MATERICA		•		•	
METAL		•			

K-rite Gres porcellanato laminato / Laminated porcelain stoneware / Grès cérame laminé / Laminiertes Feinsteinzeug
 Spessore 6,5 mm / Thickness 6,5 mm / Épaisseur 6,5 mm / Dicke 6,5 mm

PIETRA D'ISEO	Naturale			•	
VANITY	Glossy/Touch			•	
WOODLAND	Soft/Wild				•

								
20x180	50x150	120x120	60x120	20x120	100x100	50x100	60x60	50x50
8"x71"	19 1/2"x59"	48"x48"	24"x48"	8"x48"	39"x39"	19 1/2"x39"	24"x24"	19 1/2"x 19 1/2"

					•	•		
					•	•		•
					•			
					•	•		•
					•			
					•			
					•			
					•			

only Matrix

					•	•		
	•				•			
	only Work				•	only Cem		
					•			
					•	•		
					•	•		
•				•				
					•	•		
					•			

only Matrix

		•	•				•	
		•						
				•				

TABELLE CALIBRI

SIZE TABLE | TABLEAUX DES CALIBRES | FORMATTABELLEN

14mm EXTRA THICK PORCELAIN STONWARE		Gres porcellanato spessorato Extra thick porcelain stoneware Grès cérame à épaisseur majorée Extra-Dickes Feinsteinzeug	Spessore 14 mm Thickness Épaisseur Dickes
90x90 RETT.		88x88 RETT.	
CALIBRO-CALIBRE CALIBRE-KALIBER	W*(mm)	CALIBRO-CALIBRE CALIBRE-KALIBER	W*(mm)
O P Q=E	901x901 898x898 895x895	S T U	881x881 878x878 875x875
30x90 RETT.		75x75 RETT.	
CALIBRO-CALIBRE CALIBRE-KALIBER	W*(mm)	CALIBRO-CALIBRE CALIBRE-KALIBER	W*(mm)
O P Q	299x901 298x898 297x895	O P Q=E	750,5x750,5 748,0x748,0 745,5x745,5
60x120 RETT.		58x116 RETT.	
CALIBRO-CALIBRE CALIBRE-KALIBER	W*(mm)	CALIBRO-CALIBRE CALIBRE-KALIBER	W*(mm)
O P Q R	600x1202 598x1198 596x1195 595x1192	S T U	580,0x1162,0 578,0x1158,0 576,0x1155,0
20x120 RETT.		15x120 RETT.	
CALIBRO-CALIBRE CALIBRE-KALIBER	W*(mm)	CALIBRO-CALIBRE CALIBRE-KALIBER	W*(mm)
O P Q	198,7x1202 198,0x1198 197,0x1195	O P Q	148,5x1202 148,0x1198 147,0x1195
30x180 RETT.		20x180 RETT.	
CALIBRO-CALIBRE CALIBRE-KALIBER	W*(mm)	CALIBRO-CALIBRE CALIBRE-KALIBER	W*(mm)
O P Q=E	298x1803 297x1799 296x1795	O P Q=E	198,7x1803 198,8x1799 197,0x1795
60x60 RETT.		30x60 RETT.	
CALIBRO-CALIBRE CALIBRE-KALIBER	W*(mm)	CALIBRO-CALIBRE CALIBRE-KALIBER	W*(mm)
O P Q R	600x600 598x598 596x596 595x595	O P Q R	299x600 298x598 297x596 296x595
30x30		15x30	
CALIBRO-CALIBRE CALIBRE-KALIBER	W*(mm)	CALIBRO-CALIBRE CALIBRE-KALIBER	W*(mm)
I Q T U V W Y	296,4x296,4 297,6x297,6 298,8x298,8 300,0x300,0 301,2x301,2 302,4x302,4 303,6x303,6	I Q T U V W Y	146,2x296,4 146,8x297,6 147,4x298,8 148,0x300,0 148,6x301,2 149,2x302,4 149,8x303,6
20mm EXTRA THICK PORCELAIN STONWARE		Gres porcellanato superspessorato Ultra thick porcelain stoneware Grès cérame à épaisseur fortement majorée Super-Dickes Feinsteinzeug	Spessore 20 mm Thickness Épaisseur Dickes
60x60 RETT.		60x120 RETT.	
CALIBRO-CALIBRE CALIBRE-KALIBER	W*(mm)	CALIBRO-CALIBRE CALIBRE-KALIBER	W*(mm)
O P Q R	600x600 598x598 596x596 595x595	O P Q R	600x1202 598x1198 596x1195 595x1192
75x75 RETT.		30x120 RETT.	
CALIBRO-CALIBRE CALIBRE-KALIBER	W*(mm)	CALIBRO-CALIBRE CALIBRE-KALIBER	W*(mm)
O P Q	750,5x750,5 748x748 745x745	O P Q R	299x1202 298x1198 297x1195 296x1192

Kerlite 3plus THE PORCELAIN STONWARE		Gres porcellanato laminato Laminated porcelain stoneware Grès cérame laminé Laminiertes Feinsteinzeug	Spessore 3,5 mm Thickness Épaisseur Dickes
PER TUTTI I FORMATI DI KERLITE 3PLUS IL VALORE NOMINALE INDICATO COINCIDE CON LA DIMENSIONE REALE.			
FOR ALL KERLITE 3PLUS SIZES, THE RATED SIZE CORRESPONDS WITH THE ACTUAL SIZE. POUR TOUS LES FORMATS DE KERLITE 3PLUS, LA VALEUR NOMINALE INDIQUÉE CORRESPOND AUX DIMENSIONS RÉELLES. BEI ALLEN FORMATEN VON KERLITE 3PLUS STIMMT DER ANGEGEBENE NENNWERST HUNDERTPROZENTIG MIT DEN REALEN ABMESSUNGEN ÜBEREIN.			
Kerlite 3plus THE PORCELAIN STONWARE		Gres porcellanato laminato Laminated porcelain stoneware Grès cérame laminé Laminiertes Feinsteinzeug	Spessore 5,5 mm Thickness Épaisseur Dickes
100x300		33x300	
CALIBRO-CALIBRE CALIBRE-KALIBER	W*(mm)	CALIBRO-CALIBRE CALIBRE-KALIBER	W*(mm)
F	997x3000	F	330x3000
100x250		20x180	
CALIBRO-CALIBRE CALIBRE-KALIBER	W*(mm)	CALIBRO-CALIBRE CALIBRE-KALIBER	W*(mm)
F	997x2500	F	197x1800
100x100		20x150	
CALIBRO-CALIBRE CALIBRE-KALIBER	W*(mm)	CALIBRO-CALIBRE CALIBRE-KALIBER	W*(mm)
F	997x997	F	197x1500
50x150		50x100	
CALIBRO-CALIBRE CALIBRE-KALIBER	W*(mm)	CALIBRO-CALIBRE CALIBRE-KALIBER	W*(mm)
F	497x1500	F	497x997
20x120			
CALIBRO-CALIBRE CALIBRE-KALIBER	W*(mm)		
F	197x1200		
Kerlite 3plus THE PORCELAIN STONWARE		Gres porcellanato laminato Laminated porcelain stoneware Grès cérame laminé Laminiertes Feinsteinzeug	Spessore 6,5 mm Thickness Épaisseur Dickes
120x260		120x250	
CALIBRO-CALIBRE CALIBRE-KALIBER	W*(mm)	CALIBRO-CALIBRE CALIBRE-KALIBER	W*(mm)
P	1198x2600	P	1198x2500
120x240		30x240	
CALIBRO-CALIBRE CALIBRE-KALIBER	W*(mm)	CALIBRO-CALIBRE CALIBRE-KALIBER	W*(mm)
P	1198x2398	P	298x2398
20x120		60x60	
CALIBRO-CALIBRE CALIBRE-KALIBER	W*(mm)	CALIBRO-CALIBRE CALIBRE-KALIBER	W*(mm)
P	198x1198	P	598x598
40x120		120x120	
CALIBRO-CALIBRE CALIBRE-KALIBER	W*(mm)	CALIBRO-CALIBRE CALIBRE-KALIBER	W*(mm)
P	398x1198	P	1198x1198
60x120			
CALIBRO-CALIBRE CALIBRE-KALIBER	W*(mm)		
P	598x1198		

SUGGERIMENTI PER LA POSA

LAYING SUGGESTIONS | CONSEILS POUR LA POSE | EMPFEHLUNGEN FÜR DAS VERLEGEN

È compito del posatore controllare sempre il materiale prima della posa. Stendere a terra alcune piastrelle (circa 3 mq) e verificarne accuratamente le specifiche tecniche ed estetiche d'insieme.

The person in charge of installation must check all material before installing it. Place some tiles on the floor (approx. 3 m²) and check the overall technical and aesthetic characteristics with particular care.

Le poseur doit donc toujours contrôler le matériel avant la pose. Poser quelques carreaux (environ 3 m²) sur le sol sans les coller et en contrôler soigneusement les spécifications techniques et esthétiques générales.

Es ist Aufgabe des Fliesenlegers das Material vor der Verlegung stets zu kontrollieren. Einige Fliesen auf den Boden legen (circa 3 qm) und sorgfältig die spezifischen ganzheitlichen Technik und Ästhetik überprüfen.

POSA

Con collanti indicati per prodotti a bassa porosità. Dopo aver effettuato la stuccatura, rimuovere in breve tempo con frequenti lavaggi di spugna ed acqua gli eccessi fino alla totale pulizia del pavimento. Successivamente fare lavaggio acido e alcalino come da istruzioni cotto d'este. (Per le informazioni di posa riguardanti la serie wonderwall vedi pag. 368-369)

LAYING

With adhesives for products with a low porosity. After grouting, remove any excess product as quickly as possible by repeatedly washing the area with a sponge and water. Then perform acid washing, as instructed by cotto d'este. (For information on the installation of the wonderwall series please see page 368-369)

POSE

Avec des colles adaptées aux produits à faible porosité. Après avoir effectué le stucage, éliminer rapidement les excès par des lavages fréquents avec une éponge et de l'eau jusqu'à ce que le sol soit complètement propre. Effectuer ensuite le lavage acide et alcalin selon les instructions fournies par cotto d'este. Sous-couche: lit de ciment compact. (Pour plus d'informations concernant la pose de la série wonderwall, consultez la page 368-369)

VERLEGUNG

Mit klebern für produkte mit geringer porosität. Nach vorgenommener spachtelung schnell mit häufigem reinigen mit schwamm und wasser das überschüssige material bis zur vollständigen reinigung des fußbodens entfernen. Anschließend saures und alkalines nachspülen vornehmen, gemäß den vorgaben von cotto d'este. (Für die verlegungsinformationen betreffend der serie wonderwall siehe seite 368-369)

SOTTOFONDO

Massetto cementizio.

SUBSTRATE

Compact cement bed.

SOUS-COUCHE

Lit de ciment compact.

UNTERGRUND

Kompakter Zementestrich.

DIMENSIONE FUGA

2 mm per i prodotti rettificati e 4 mm per i prodotti non rettificati. Salvo diversa indicazione dei Codici di Posa Nazionali. La larghezza delle fughe deve comunque essere decisa dalla Direzione Lavori.

JOINT WIDTH

2 mm for rectified tiles and 4 mm for not ground tiles. The width of grout joints must be established by the installation supervisor, unless grout widths are regulated by national laying standards.

DIMENSION JOINT

2 mm pour les carreaux rectifiés et 4 mm pour les carreaux pas rectifiés. Sauf indication contraire contenue dans les Normes de Pose Nationaux, la dimension des joints doit en tous cas être définie par le directeur des travaux.

FUGENBREITE

2 mm für geschliffene Platten und 4 mm für ungeschliffene Platten. Sofern in den Nationalen Verlegungsstandards nicht anders angegeben, ist die Breite der Fugen von der Bauleitung zu bestimmen.

COLORE FUGA

Grigio cemento o colore in tono con la piastrella. Prima di usare stucchi colorati a grana fine su prodotti lappati, LEVIGATI O SPAZZOLATI, fare sempre un test di prova. Se il pigmento colorato è molto tenace la rimozione potrebbe risultare molto difficoltosa.

GROUT COLOUR

Grey or matching the colour of the tile. Before using fine-grain coloured grout on lapped, polished or brushed products, always perform a test. If the coloured pigment is very adhesive, it may be very difficult to remove.

COULEUR JOINT

Ciment gris ou dans la teinte du carreau. Toujours effectuer un test avant d'utiliser des stucs colorés a granulometrie fine sur des produits ponces, polis et brossés. L'élimination d'un pigment tres prononce pourrait s'averer difficile.

FUGENFARBE

Grau oder auf die Fliesenfarbe abgestimmt. Bevor farbige fugenfüller mit feiner körnung auf geläppten, gehonten und gebürsteten produkten eingesetzt werden ist stets eine probeanwendung erforderlich. Wenn das farbpigment sehr resistent ist, könnte der fugenfüller sehr schwer zu entfernen sein.

GRADINO PLUS STEP TREAD PLUS | NEZ DE MARCHE PLUS | PLUS-STUFEN

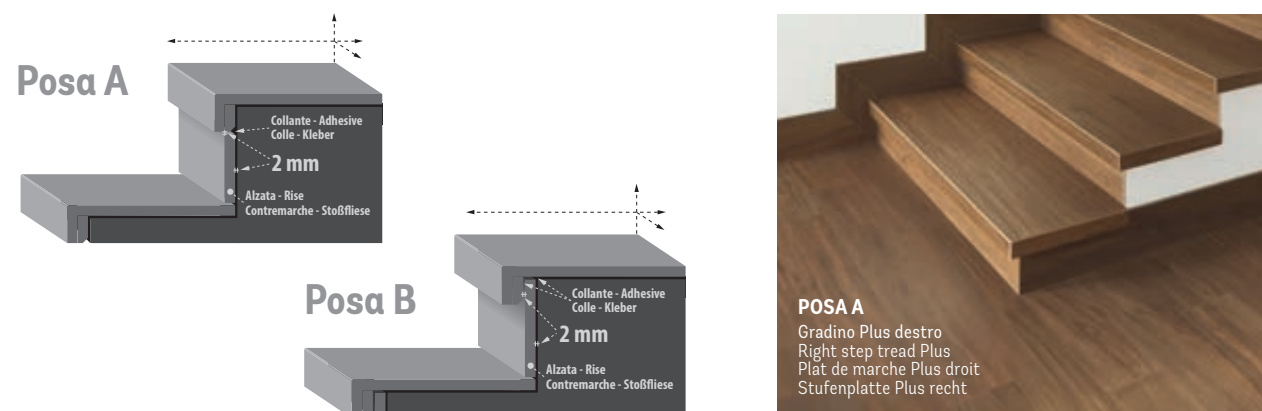

INFORMAZIONI PER LA POSA

LAYING INFORMATION | INFORMATIONS POUR LA POSE | INFORMATIONEN FÜR DIE VERLEGUNG

Effettuare sempre la posa con adesivo. Per la posa su sottofondi cementizi utilizzare adesivi elastici di classe S2 secondo EN 12004. Nel caso di posa su altri supporti (es. legno, truciolare...) contattare i fornitori per la scelta dell'adesivo più idoneo.

Verificare che il sottofondo sia stabile, planare e pulito. Gli strati cementizi (massetti, calcestruzzo, strati di livellamento/pendenza...) devono essere stagionati, cioè devono aver esaurito i fenomeni di ritiro.

Evitare la presenza di acqua sul sottofondo. Nel caso in cui la pavimentazione in esercizio sarà a contatto con l'acqua (ambienti esterni, centri benessere, docce, spogliatoi...) è necessario:

- realizzare sottofondi con pendenza di almeno l'1% (1 cm per ogni metro);
- applicare idonei impermeabilizzanti sulla superficie del sottofondo;
- miscelare gli stucchi con idonei laticci che riducano la porosità delle fughe.

NON LASCIARE VUOTI sotto ai Gradini Plus, posare con "doppia spalmatura" anche nella parte verticale dei pezzi. Il bordo verticale del Gradino Plus deve essere distanziato di alcuni mm (almeno 3-4 mm) dal sottofondo e lo spazio vuoto deve essere riempito con collante, v. figure.

Calpestare i Gradini Plus e riempire le fughe solo quando l'adesivo ha fatto presa secondo le indicazioni riportate dai fabbricanti.

Posare sempre con la fuga, che dovrà avere idonee dimensioni e comunque calcolata dal progettista.

Prevedere nella pavimentazione i giunti perimetrali a contatto con elementi strutturali verticali (muri, colonne...) ed idonei giunti di dilatazione.

Evitare sistemi rigidi:

- volendo rivestire la parte verticale degli scalini ("alzata"), posare il materiale ben distanziato dai Gradini Plus, come mostrato nelle figure.
- nel caso di terrazze o balconi, assicurarsi che le eventuali grondaie siano un sistema a sé stante, cioè siano ben distaccate dai Gradini Plus.

Always lay using adhesive.

When laying on cement bases use elastic class S2 EN 12004 compliant adhesive. When laying on other bases (e.g. wood, chipboard...) contact suppliers for the choice of the best adhesive.

Check that the base is stable, flat and clean. Cement layers (screed, concrete, levelling/sloping layers...) must be seasoned, that is must have withdrawn completely.

Avoid any water on the base. If flooring in use is in contact with water (exteriors, wellness centres, showers, changing rooms...) you need to:

- Create bases with a slope of at least 1% (1 cm for each metre)
- Apply suitable waterproofing to the base
- Mix the stucco with suitable latexes to reduce porosity of fugues.

DO NOT LEAVE EMPTY SPACES under the "Plus" Steps; lay by "double spreading" even for vertical parts.

The vertical parts of "Plus" Steps must be spaced a few mm (at least 3-4 mm) from the base and the empty space must be filled with glue, see pictures.

Walk on the "Plus" Steps and only fill fugues when the adhesive holds following manufacturer instructions. Always lay with fugues of the right size, calculated by the designer.

Plan for perimeter joints in flooring coming into contact with vertical structural elements (walls, columns...) and suitable expansion joints.

Avoid rigid systems:

- If you want to cover the vertical part of steps ("rise"), lay the material the right distance from the "Plus" Steps, as shown in the pictures.
- For terraces and balconies, makes sure any gutters are a system to themselves; that is are well separated from the "Plus" Steps.

Effectuer toujours la pose collée.

Pour la pose sur les sous-couches en ciment, utiliser des colles élastiques de classe S2 conformes à la norme EN 12004. En cas de pose sur d'autres supports (ex. bois, mélaminé...) contacter les fournisseurs pour le choix de la colle la plus appropriée.

Vérifier que la sous-couche est stable, plane et propre. Les temps de séchage du support (chapes, béton armé, produits de ragréage...) doivent être parfaitement respectés c'est-à-dire que les phénomènes de retrait doivent être terminés.

Éviter la présence d'eau sur la sous-couche. Si le sol à carrelé doit entrer en contact avec l'eau (pose en extérieur, centres bien-être, douches, vestiaires...) il est nécessaire:

- de réaliser une sous-couche avec une pente d'au moins 1% (1 cm/mètre)
- d'appliquer des imperméabilisants appropriés sur la sous-couche
- de gâcher les mortiers avec des latex appropriés qui réduisent la porosité des jointoiments.

NE PAS LAISSER DE VIDES sous les nez de marche "Plus"; appliquer la colle avec la technique du double encollage (support et envers des carreaux), ainsi que sur le bord vertical des carreaux.

Le bord vertical des nez de marche "Plus" doit être à une distance de quelques mm (au moins 3-4 mm) de la sous-couche et l'espace vide doit être rempli avec de la colle, voir les figures.

Ne piétiner les nez de marche "Plus" et ne remplir les joints que lorsque la colle a déjà fait prise, selon les indications fournies par les fabricants.

Poser toujours avec un joint dont les dimensions seront calculées par le projeteur.

Prévoir sur le carrelage des joints périphériques aux points de contact avec les éléments structurels verticaux (mur, colonnes...) et des joints de dilatation opportuns.

Éviter les systèmes rigides :

- si l'on désire carrelé la partie verticale des marches (contremarche), poser les carreaux à une certaine distance des nez de marche "Plus" comme le montrent les figures.
- Pour les terrasses et les balcons, s'assurer que gouttières sont totalement indépendantes, c'est-à-dire bien séparées des nez de marche "Plus".

Zum Verlegen immer Kleber verwenden.

Zum Verlegen auf zementhaltigem Untergrund elastische Kleber der Klasse S2 gemäß EN 12004 verwenden. Wenden Sie sich beim Verlegen auf anderen Unterlagen (z.B. Holz, Spanplatten usw.) für die Wahl des geeigneten Klebers an die Händler.

Prüfen Sie, dass der Verlegeuntergrund stabil, eben und sauber ist. Die zementhaltigen Schichten (Estrich, Betonuntergrund, Nivellierschicht bzw. Gefälle, usw.) müssen abgelagert sein, d.h. die Schrumpfung muss abgeschlossen sein.

Es darf sich kein Wasser auf dem Untergrund befinden. Sollte der zu verlegende Fußboden in Kontakt mit Wasser gelangen (Außenbereiche, Wellness-Center, Duschen, Umkleieräume usw.) ist Folgendes zu beachten:

- Den Verlegeuntergrund mit einer Neigung von mindestens 1% erstellen (1 cm pro Meter)
- Geeignete Dichtstoffe auf der Oberfläche des Untergrunds anbringen
- Die Gipsmörtel mit einem geeignetem Latex mischen, um die Durchlässigkeit der Fugen zu verringern.

KEINE LEERRÄUME unter den Plus-Stufen HINTERLASSEN; auch den vertikalen Abschnitt der Elemente mit "Doppelbeschichtung" verlegen.

Die vertikale Kante der Plus-Stufen muss einige mm Abstand (mind. 3-4 mm) zum Verlegeuntergrund aufweisen; dabei ist der Leerraum mit Kleber zu füllen, siehe Abbildungen.

Die Plus-Stufen betreten und die Fugen erst verschließen, nachdem der Kleber entsprechend der Herstellerangaben gehärtet ist.

Immer mit der Fuge verlegen, wobei deren Größe, die vom Projektplaner berechnet wird, angemessen sein muss.

Kalkulieren Sie bei der Fußbodenverlegung die umlaufenden Fugen, welche mit vertikalen Konstruktionselementen (Mauern, Säulen, usw.) in Kontakt stehen, sowie die Dehnungsfugen mit ein.

Vermeiden Sie starre Systeme:

- Bei der Verkleidung des vertikalen Abschnitts der Stufen ("Setzstufe") das Material in einem angemessenen Abstand zu den Plus-Stufen verlegen, siehe Abbildungen.
- Bei Terrassen oder Balkons sicherstellen, dass die evtl. vorhandenen Dachrinnen ein unabhängiges System darstellen, d.h. einen angemessenen Abstand zu den Plus-Stufen aufweisen.

GRADONE COSTA RETTA RIGATO CON GOCCIOLATOIO STEP TREAD STRAIGHT EDGE WITH GROOVES AND DRIP FLAP | PLAT DE MARCHE À BORD DROIT AVEC RAINURES ET GOUTTE D'EAU | STUFENPLATTE MIT GERADER KANTE UND ABTROPFRILLE

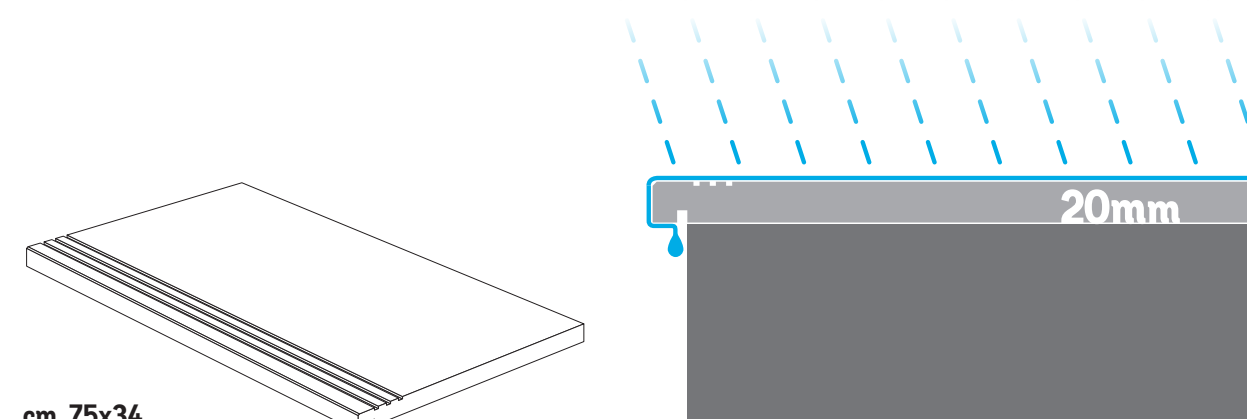

cm. 75x34







Disponibile in - Available in:
Cluny | Pietra d'Iseo







cm. 60x30

Disponibile in - Available in:
Bluestone Evolution / Cement Project / Limestone / Secret Stone / Stonequartz / X-Beton

GARANZIA COTTO D'ESTE

COTTO D'ESTE GUARANTEE | COTTO D'ESTE GARANTIE | COTTO D'ESTE GARANTIE

		RESIDENZIALE RESIDENTIAL RÉSIDENTIEL WOHNBEREICH		PUBBLICO PUBLIC PUBLIC ÖFFENTLICH	
					
		GARANTITO 20 ANNI GUARANTEED 20 YEARS GARANTIE 20 ANS 20 JAHRE GARANTIERT	GARANTITO 10 ANNI GUARANTEED 10 YEARS GARANTIE 10 ANS 10 JAHRE GARANTIERT	GARANTITO 20 ANNI GUARANTEED 20 YEARS GARANTIE 20 ANS 20 JAHRE GARANTIERT	GARANTITO 10 ANNI GUARANTEED 10 YEARS GARANTIE 10 ANS 10 JAHRE GARANTIERT
 14mm Gres porcellanato spessorato Extra thick porcelain stoneware Grès cérame à épaisseur majorée Extra-Dickes Feinsteinzeug		Spessore 14 mm Thickness Épaisseur Dickes			
BUXY	Nat Rett.	•		•	
	Lux Rett.	•		•	
CADORE	Rett.	•		•	
CASALI		•		•	
CEMENT PROJECT	Land Naturale Rett. Land Lappata Rett.	•		•	
CLUNY	Sablé Rett. - Adouci Rett.	•		•	
	Layé Rett.	•		•	
EXEDRA	Silk Rett.	•			•
	Glossy Rett.		•		
LIMESTONE	Natural Rett. - Blazed Rett. Honed Rett.	•		•	
SECRET STONE	Natural Rett. - Honed Rett.	•		•	
	Grip Rett.	•		•	
STONEQUARTZ	Fiammata Rett.	•		•	
X-BETON	Naturale Rett. Satinata Rett.	•		•	
 20mm Gres porcellanato superspessorato Ultra thick porcelain stoneware Grès cérame à épaisseur fortement majorée Super-Dickes Feinsteinzeug		Spessore 20 mm Thickness Épaisseur Dickes			
BLUESTONE EVOLUTION	Rockstone Rett.	•		•	
CADORE	Naturale Rett.	•		•	
CEMENT PROJECT	Work Rett.	•		•	
CLUNY	Layé Rett.	•		•	
LIMESTONE	Fiammata Rett.	•		•	
PIETRA D'ISEO	Rett.	•		•	
SECRET STONE	Bocciardata Rett.	•		•	
STONEQUARTZ	Fiammata Rett.	•		•	
X-BETON	Fiammata Rett.	•		•	

		RESIDENZIALE RESIDENTIAL RÉSIDENTIEL WOHNBEREICH		PUBBLICO PUBLIC PUBLIC ÖFFENTLICH	
					
		GARANTITO 20 ANNI GUARANTEED 20 YEARS GARANTIE 20 ANS 20 JAHRE GARANTIERT	GARANTITO 10 ANNI GUARANTEED 10 YEARS GARANTIE 10 ANS 10 JAHRE GARANTIERT	GARANTITO 20 ANNI GUARANTEED 20 YEARS GARANTIE 20 ANS 20 JAHRE GARANTIERT	GARANTITO 10 ANNI GUARANTEED 10 YEARS GARANTIE 10 ANS 10 JAHRE GARANTIERT
 Kerlite Gres porcellanato laminato Laminated porcelain stoneware Grès cérame laminé Laminiertes Feinsteinzeug		Spessore 3,5 mm Thickness Épaisseur Dickes			
BLACK-WHITE		•			•
BUXY		•		•	
CLUNY	Naturale	•		•	
OVER	Naturale	•		•	
	Soft	• Road	• Openspace, Loft, Office		• Road
WONDERWALL		• Matrix, Ritmi		• Matrix, Ritmi	
 Kerlite Gres porcellanato laminato Laminated porcelain stoneware Grès cérame laminé Laminiertes Feinsteinzeug		Spessore 5,5 mm Thickness Épaisseur Dickes			
BLACK-WHITE	Glossy ³		•		
	Silk ³		•		•
CEMENT PROJECT	Work - Cem	•		•	
CLUNY	Layé	•		•	
ELEGANCE	Silk ²		•		•
EXEDRA	Glossy ³		•		
	Silk ²		•		•
FOREST		•		•	
LIMESTONE	Natural	•		•	
MATERICA		•		•	
METAL		•			•
 Kerlite Gres porcellanato laminato Laminated porcelain stoneware Grès cérame laminé Laminiertes Feinsteinzeug		Spessore 6,5 mm Thickness Épaisseur Dickes			
PIETRA D'ISEO	Naturale	•		•	
VANITY	Glossy/Touch		•		•
WOODLAND	Soft/Wild	•		•	

1 Ideale per rivestimenti e consigliato per pavimenti in ambienti residenziali. | Ideal for wall installation and recommended for floor installation in residential areas only. | Idéal pour le revêtement mur et proposé pour le revêtement sol uniquement dans des zones résidentielles. | Geeignet für Wandverlegung und empfohlen für Bodenverlegung nur im Wohnbereiche.

2 Ideale per rivestimenti e consigliato per pavimenti in ambienti residenziali e commerciale leggero (vedi tabella pag. 312). | Ideal for wall installation and recommended for flooring in residential and low-traffic commercial spaces (see table on pg. 312). | Idéal pour le revêtement mur et recommandé pour les sols dans des espaces résidentiels et commerciaux (petits). (Voir le tableau p. 312). | Geeignet für Wandverlegung und empfohlen für Fußböden in Wohnbereichen und leichte gewerbliche Nutzung (siehe Tabelle Seite 312).

3 La presenza sporadica di piccole disuniformità o di puntini sulla superficie è da ritenere caratteristica del materiale e della sua particolare lavorazione. Ideale per rivestimenti e consigliato per pavimenti in ambienti residenziali (vedi tabella pag. 312). | The sporadic presence of small non-uniformities or dots on the surface is to be considered characteristic of the material and of its finishing. Ideal for wall installation and recommended for floor installation in residential areas only (see table on pg. 312). | La présence sporadique de petites non-uniformités ou de petits points sur la surface sont une caractéristique du produit et de son traitement particulier. Idéal pour le revêtement mur et proposé pour le revêtement sol uniquement dans des zones résidentielles (Voir le tableau p. 312). | Das vereinzelte Vorkommen von kleinen Ungleichmäßigkeiten oder Pünktchen auf der Oberfläche ist als charakteristisch für das Material und dessen spezielle Bearbeitung zu betrachten. Geeignet für Wandverlegung und empfohlen für Bodenverlegung nur im Wohnbereiche (siehe Tabelle Seite 312).

PULIZIA E TRATTAMENTI CARE AND TREATMENT | NETTOYAGE ET TRAITEMENTS | REINIGUNG UND BEHANDLUNG



VISIBILITÀ DELLE IMPRONTE

TREAD MARK VISIBILITY | VISIBILITÉ DES EMPREINTES | SICHTBARKEIT VON FUSSSPUREN

Metodo Cotto d'Este	Cotto d'Este Method	Méthode Cotto d'Este	Cotto d'Este Verfahren
Questa classificazione specifica il grado di visibilità delle impronte rilasciate sul pavimento dopo il passaggio con scarpe sporche di polvere. A - Impronta non visibile B - Impronta poco visibile C - Impronta molto visibile. Ideale per rivestimenti e consigliato per pavimenti solo in ambienti residenziali.	This classification specifies the visibility degree of the tread marks left on the floor after walking with shoes dirty of dust. A - Tread mark not visible B - Tread mark not very visible. C - Tread mark very visible. Ideal for wall installation and recommended for floor installation in residential areas only.	Cette classification indique le degré de visibilité des empreintes laissées sur le sol après le passage avec des chaussures couvertes de poussière. A - Empreinte non visible B - Empreinte peu visible C - Empreinte fort visible. Idéal pour le revêtement mur et proposé pour le revêtement sol uniquement dans des zones résidentielles.	Diese Klassifikation bezeichnet den Grad der Sichtbarkeit von Fußspuren, wenn der Boden mit staubigen Schuhen überquert wird. A - Keine Spuren sichtbar. B - Schwach sichtbare Spuren. C - Gut sichtbare Spuren. Geeignet für Wandverlegung und empfohlen für Bodenverlegung nur im Wohnbereiche.



FACILITÀ DI PULIZIA

CLEANING EASINESS | FACILITÉ D'ÉLIMINATION DE LA TACHE | REINIGUNGSAUFWAND

Metodo Cotto d'Este	Cotto d'Este Method	Méthode Cotto d'Este	Cotto d'Este Verfahren
Il metodo consiste nel classificare il grado di facilità nella rimozione dello sporco generico mediante pulizia manuale con detergente debole. Grado 1 Molto facile, nessuna resistenza dello sporco, rimozione immediata. Grado 2 Facile, leggera resistenza dello sporco, rimozione veloce. Grado 3 Meno facile, maggiore resistenza dello sporco, rimozione lenta. Si consiglia detergente forte. Ideale per rivestimenti e consigliato per pavimenti solo in ambienti residenziali.	The method consists in classifying the easiness grade in removing general dirt by manual cleaning with mild detergent. Grade 1 Very easy, no resistance of the dirt, immediate removal. Grade 2 Easy, light resistance of the dirt, fast removal. Grade 3 Less easy, higher resistance of the dirt, slow removal. A strong detergent is recommended. Ideal for wall installation and recommended for floor installation in residential areas only.	La méthode consiste à classifier le degré d'élimination de la tache de la saleté en général par un nettoyage manuel avec un produit léger. Degré 1 Très facile, aucune résistance à la saleté, nettoyage immédiat. Degré 2 Facile, légère résistance à la saleté, nettoyage rapide. Degré 3 Moins facile, une plus grande résistance à la saleté, nettoyage moins rapide. Il est conseillé d'utiliser un nettoyant fort. Idéal pour le revêtement mur et proposé pour le revêtement sol uniquement dans des zones résidentielles.	Diese Methode klassifiziert den Aufwand, dessen es bedarf, um normalen Schmutz von Hand und mit einem leichten Reinigungsmittel zu entfernen. 1. Grad Sehr einfach zu entfernen, Schmutz nicht resistent, sofortiges Entfernen. 2. Grad Einfach, Schmutz etwas resistent, rasches Entfernen. 3. Grad Grad Weniger einfach, Schmutz resistenter, langsames Entfernen. Es wird empfohlen, ein stärkeres Geeignet für Wandverlegung und empfohlen für Bodenverlegung nur im Wohnbereiche.

PULIZIA “DOPOPOSA”

“AFTER-INSTALLATION” CLEANING | NETTOYAGE APRÈS LA POSE | REINIGUNG “NACH DEM VERLEGEN”

1	2	3	4
La pulizia “dopoposa” è obbligatoria a fine cantiere, sia per le piastrelle smaltate che non smaltate.	“After-installation” cleaning is compulsory, both for glazed and non-glazed tiles.	Le nettoyage après la pose est obligatoire pour les carreaux émaillés ainsi que pour les carreaux non émaillés.	Die Reinigung “nach dem Verlegen” ist sowohl für glasierte als auch unglasierte Fliesen obligatorisch.
Una pulizia dopoposa male effettuata, o addirittura non fatta, è spesso causa di alonature che impediscono di mantenere pulito il pavimento nonostante una buona pulizia quotidiana.	An after-installation cleaning carried out not accurately, or not carried out at all, often results in halos preventing the floor to be kept clean despite of a careful daily cleaning.	Si le nettoyage après la pose n'est pas soigné ou s'il n'a pas été effectué, des halos peuvent se former sur le carrelage et le sol peut devenir impossible à nettoyer, même lorsque les opérations de nettoyage sont effectuées quotidiennement.	Oft sind hartnäckige, auch bei der täglichen Reinigung, nicht zu entfernende Flecken und Schmutzränder auf eine unsachgemäße oder überhaupt nicht erfolgte Reinigung nach dem Verlegen zurückzuführen.
A garanzia di una pulizia ottimale si consiglia l'uso di monospazzola con dischi appropriati (verde per superfici strutturate/antiscivolo, rosso per le altre).	To ensure an optimal cleaning, the use of a single brush with suitable disks (green for structured/anti-slip surfaces, red for the others) is recommended.	Pour un nettoyage approfondi, utiliser une monobrosse avec des disques appropriés (verts pour les surfaces structurées/antidérapantes et rouges pour les autres surfaces).	Eine einwandfreie Reinigung ist durch den Einsatz einer Einscheibenmaschine mit geeigneten Scheiben gewährleistet (grüne Scheiben für strukturierte/rutschfeste Oberflächen, rote Scheiben für andere Oberflächenbeschaffenheiten).

4

STUCCHI CEMENTIZI MISCELATI CON ACQUA	CEMENTITIOUS GROUTS MIXED WITH WATER	COULIS DE CIMENT MÉLANGÉS AVEC DE L'EAU	ZEMENTSTUCK AUF WASSERBASIS
Per rimuovere i residui di cemento, boiaccia, calce, stucchi cementizi per le fughe, ecc..., si deve effettuare la pulizia “dopoposa” almeno dopo 4-5 giorni dalla posa (per consentire così l'indurimento dello stucco) e mai oltre i 10 giorni. Oltre questi tempi la pulizia può diventare molto più laboriosa. Si effettua con specifici detergenti a base di acidi tamponati. Tali detergenti sono facilmente reperibili in commercio, alcuni di questi sono riportati nella seguente tabella.	To remove the residues of cement, slurry, lime, cementitious grouts for joints, etc... the “after-installation” cleaning must be carried out at least after 4-5 days from the installation (so that the grout can harden) and never beyond 10 days. Later, cleaning can be much more wearisome. It is carried out with special detergents based on buffered acids. Such detergents can be easily found on the market; a few of them are indicated in the table below.	Avant d'enlever les résidus de ciment, de mortier, de chaux et de coulis de ciment des joints, etc., attendre au moins 4 ou 5 jours après la pose (cela afin de permettre au coulis des joints de sécher complètement) et puis nettoyer le carrelage. Ne pas attendre plus de 10 jours. Après 10 jours, les opérations de nettoyage peuvent devenir beaucoup plus complexes.Utiliser des détergents spécifiques à base d'acides tamponnés. Ces détergents sont normalement disponibles dans le commerce. Dans le tableau suivant figure une liste des produits de nettoyage conseillés.	Um Zement-, Schlacken-, Kalk-, Stuckrückstände u.Ä. aus Fugenmaterialien zu entfernen, ist mindestens 4-5 Tage nach dem Verlegen und nie später als 10 Tage danach (damit der Stuck aushärtet) eine Reinigung erforderlich. Nachdem diese Zeit verstrichen ist, kann diese Reinigung u.U. sehr schwierig werden. In diesem Fall müssen spezielle Reiniger auf Puffersäurebasis eingesetzt werden. Diese Reinigungsmittel sind leicht im Handel erhältlich. In der folgenden Tabelle sind einige dieser Reiniger aufgelistet.

Residuo da rimuovere	Residue to be removed	Résidu à enlever	Rückstände
Stucchi cementizi, boiaccia, cemento, calce	Cementitious grouts, slurry, cement, lime	Mortier à base de ciment, coulis, ciment et chaux	Zementstuck, Schlacke, Zement, Kalk.
Tipo di detergente	Detergent type	Type de détergent	Reinigertyp
A base acida	Acid-based	À base acide	Auf Säurebasis
Nome detergente (Produttore)	Detergent name (Manufacturer)	Nom du détergent (Producteur)	Bezeichnung des Reinigers (Hersteller)
	SOLVACID (GEAL) - KERANET (MAPEI) - CEMENT REMOVER (FABERCHIMICA) - DETERDEK (FILA) - TREK (KITER) - HMK R63 (HMK) ZEMENTSCHLEIERENTFERNER (LITHOFIN) - LITOCLEAN PLUS (LITOKOL) - BONACLEAN/BCLEAN (BONASYSTEMS ITALIA) BONADECAN/BDECON (BONASYSTEMS ITALIA)*		
* Specifico per prodotti non resistenti agli acidi.	* Especially made for products that are not acid-resistant.	* Détergent spécifique pour les produits qui ne résistent pas aux acides.	* Spezifisch für nicht säurebeständige Produkte.

Per le modalità d'uso seguire le indicazioni specifiche dei fabbricanti.	For the use, follow the specific instructions by the manufacturers.	Pour les modes d'emploi, se conformer aux indications spécifiques fournies par chaque fabricant.	Gebrauchshinweise des Herstellers beachten.
--	---	--	---

Una volta effettuato il lavaggio sopraccitato, è necessario eseguire un lavaggio basico o alcalino utilizzando detersivi sgrassanti (vedi tabella al punto 5). Questo perché il lavaggio acido può lasciare untuosità sul pavimento che potrebbe contribuire a trattenere lo sporco.	After performing the washing described above, it is necessary to wash with a basic or alkaline product, namely a degreasing detergent (see point 5) of table). Acid washing can leave greasy marks on the floor, which tend to withhold dirt.	Au terme du lavage susmentionné, il est nécessaire d'effectuer un nettoyage basique ou alcalin avec des détergents dégraisants (voir tableau point 5) étant donné que le nettoyage acide peut laisser des traces de gras sur le sol qui pourraient contribuer à retenir la saleté.	Ist die o.g. Reinigung durchgeführt, muss eine basische oder alkalische Reinigung vorgenommen werden, bei der Entfettungsmittel zu verwenden sind (siehe Tabelle, Punkt 5). Dies ist notwendig, weil die Säurereinigung ölige Schlieren auf dem Fußboden hinterlassen könnte, die den Schmutz festhalten.
--	---	--	---

N.B. Per stucchi cementizi additivati (lattici, resine, ecc.), effettuare immediatamente la rimozione con spugna ed abbondante acqua. Poi trattare il pavimento come da istruzioni ai punti 3 e 4.	NOTE: for cementitious grouts with additives (latexes, resins, etc.), remove immediately with sponge and plenty of water. Then, treat the floor according to the instructions in points 3 and 4.	NOTE: les coulis de ciment contenant des additifs (par exemple: latex, résines, etc.), doivent être nettoyés immédiatement à l'aide d'une éponge et d'une grande quantité d'eau. Ensuite, suivre les instructions des points 3 et 4.	HINWEIS: Zementstücke mit Additiven (Latex, Harz, usw.), müssen unverzüglich mit einem Schwamm und reichlich Wasser gereinigt werden. Die Fußbodenfläche entsprechend der Anleitungen unter den Punkten 3 und 4 behandeln.
--	--	--	--

Fare sempre test preventivi prima dell'uso (su una piastrella non posata), in particolare su prodotti Lappati o Levigati.	Always make preventive tests before the use (on a tile not laid yet), above all on lapped or polished products.	Effectuer toujours des essais préventifs avant d'utiliser un produit (sur un carreau à part), en particulier avec des carrelages polis ou lissés.	Vor dem Einsatz dieser Reiniger immer Tests (auf einer nicht verlegten Fliese durchführen), dies gilt insbesondere für geläppte oder polierte Produkte.
---	---	---	---

Non fare la pulizia “dopoposa” se la temperatura delle piastrelle è elevata, in estate effettuarla nelle ore fresche della giornata.	Do not carry out the “after-installation” cleaning if the tile temperature is high; in summer, clean during the fresher hours of the day.	Éviter d'effectuer le nettoyage après la pose lorsque la température des carreaux est élevée. En été, préférer les heures fraîches de la journée.	Die Reinigung “nach dem Verlegen” nie durchführen, wenn die Fliesentemperatur hoch ist; im Sommer sollte die Reinigung zu kühleren Tageszeiten erfolgen.
--	---	---	--

PULIZIA E TRATTAMENTI

CARE AND TREATMENT | NETTOYAGE ET TRAITEMENTS | REINIGUNG UND BEHANDLUNG

Non fare la pulizia “dopoposa” se la temperatura delle piastrelle è elevata; in estate effettuarla nelle ore fresche della giornata.	Do not carry out the “after-installation” cleaning if the tile temperature is high; in summer, clean during the fresher hours of the day.	Éviter d’effectuer le nettoyage après la pose lorsque la température des carreaux est élevée. En été, préférer les heures fraîches de la journée.	Die Reinigung “nach dem Verlegen” nie durchführen, wenn die Fliesentemperatur hoch ist; im Sommer sollte die Reinigung zu kühleren Tageszeiten erfolgen.																												
5																															
<p>STUCCHI EPOSSIDICI, BI-COMPONENTI E REATTIVI</p> <p>La rimozione di questi stucchi deve essere fatta immediatamente ed in modo accurato perchè induriscono molto rapidamente, anche in pochi minuti.</p> <p>Seguire attentamente le modalità di pulizia indicate dal fabbricante dello stucco utilizzato e verificarne l’efficacia (anche conroluce) con una prova preliminare di pulizia prima di stuccare l’intero pavimento/parete.</p>	<p>CLEANING FOR EPOXY, BI-COMPONENT AND REAGENT GROUTS</p> <p>Removal of the residues of these grouts must be carried out immediately and thoroughly, as these grouts harden very rapidly, even in a few minutes.</p> <p>Please carefully follow the cleaning mode specified by the manufacturer of the grout used; verify its effectiveness (backlight also) with a preliminary cleaning test before grouting the entire floor/wall.</p>	<p>NETTOYAGE DES JOINTS EPOXY, BI-COMPOSANT ET RÉACTIF</p> <p>Le nettoyage des résidus doit être effectué immédiatement et avec soin, car ce type de matériau durcit très rapidement (en quelques minutes).</p> <p>Suivez attentivement les indications de nettoyage indiqué par le fabricant de joint utilisé et vérifiez son efficacité (même rétro-éclairage) avec un nettoyage préventif avant de jointoyer la totalité du sol/mur.</p>	<p>REINIGUNG VON EPOXI-, BI-KOMPONENT UND AKTIVEN SPACHTEL-MASSEN</p> <p>Die Reste dieser Mörtelarten müssen sofort nach dem Verlegen sorgfältig entfernt werden, da sie extrem schnell (in wenigen Minuten) erhärten.</p> <p>Die angegebene Reinigungshinweis vom Hersteller der verwendete Fugenmasse sorgfältig befolgen. Vor dem Verfugen des gesamten Belag (Boden u/o Wand), die Wirkung der Reinigungsempfehlung (auch im Gegenlicht) mit einem Vor-Test Reinigung überprüfen.</p>																												
<table border="1"> <tr><td>Operazione</td><td>Operation</td><td>Opération</td><td>Vorgang</td></tr> <tr><td>Pulizia di fondo</td><td>Thorough cleaning</td><td>Nettoyage approfondi</td><td>Gründliche Reinigung</td></tr> <tr><td>Tipo di detergente</td><td>Detergent type</td><td>Type de détergent</td><td>Reinigertyp</td></tr> <tr><td>A base alcalina</td><td>Alkali-based</td><td>À base alcaline</td><td>Auf Alkalibasis</td></tr> <tr><td>Nome detergente (Produttore)</td><td>Detergent name (Manufacturer)</td><td>Nom du détergent (Producteur)</td><td>Bezeichnung des Reinigers (Hersteller)</td></tr> <tr><td colspan="4" style="text-align:center">WAX REMOVER (FABERCHIMICA) - PS 87 (FILA) CIF (Sgrassatore con Bicarbonato / Degreaser with bicarbonate / Dégraisseur contenant du bicarbonate / Entfetter mit Bikarbonat) (UNILEVER ITALIA) LITONET (LITOKOL) - BONADECOR* (BONASYSTEMS ITALIA)</td></tr> <tr><td>* Specifico per prodotti non resistenti agli acidi.</td><td>* Especially made for products that are not acid-resistant.</td><td>* Détergent spécifique pour les produits qui ne résistent pas aux acides.</td><td>* Spezifisch für nicht säurebeständige Produkte.</td></tr> </table>	Operazione	Operation	Opération	Vorgang	Pulizia di fondo	Thorough cleaning	Nettoyage approfondi	Gründliche Reinigung	Tipo di detergente	Detergent type	Type de détergent	Reinigertyp	A base alcalina	Alkali-based	À base alcaline	Auf Alkalibasis	Nome detergente (Produttore)	Detergent name (Manufacturer)	Nom du détergent (Producteur)	Bezeichnung des Reinigers (Hersteller)	WAX REMOVER (FABERCHIMICA) - PS 87 (FILA) CIF (Sgrassatore con Bicarbonato / Degreaser with bicarbonate / Dégraisseur contenant du bicarbonate / Entfetter mit Bikarbonat) (UNILEVER ITALIA) LITONET (LITOKOL) - BONADECOR* (BONASYSTEMS ITALIA)				* Specifico per prodotti non resistenti agli acidi.	* Especially made for products that are not acid-resistant.	* Détergent spécifique pour les produits qui ne résistent pas aux acides.	* Spezifisch für nicht säurebeständige Produkte.			
Operazione	Operation	Opération	Vorgang																												
Pulizia di fondo	Thorough cleaning	Nettoyage approfondi	Gründliche Reinigung																												
Tipo di detergente	Detergent type	Type de détergent	Reinigertyp																												
A base alcalina	Alkali-based	À base alcaline	Auf Alkalibasis																												
Nome detergente (Produttore)	Detergent name (Manufacturer)	Nom du détergent (Producteur)	Bezeichnung des Reinigers (Hersteller)																												
WAX REMOVER (FABERCHIMICA) - PS 87 (FILA) CIF (Sgrassatore con Bicarbonato / Degreaser with bicarbonate / Dégraisseur contenant du bicarbonate / Entfetter mit Bikarbonat) (UNILEVER ITALIA) LITONET (LITOKOL) - BONADECOR* (BONASYSTEMS ITALIA)																															
* Specifico per prodotti non resistenti agli acidi.	* Especially made for products that are not acid-resistant.	* Détergent spécifique pour les produits qui ne résistent pas aux acides.	* Spezifisch für nicht säurebeständige Produkte.																												
6																															
<p>SUPERFICI ANTISCIVOLO</p> <p>Per loro peculiarità, le superfici antiscivolo, ruvide o strutturate, si puliscono più laboriosamente. È importante dopo la stuccatura rimuovere gli eccessi in breve tempo e con frequenti lavaggi utilizzando spugna ed acqua fino alla totale pulizia del pavimento. Successivamente fare un lavaggio acido utilizzando una monospazzola con dischi verdi.</p>	<p>ANTI-SLIP SURFACES</p> <p>Due to their special features, rough or structured anti-slip surfaces are harder to clean. After the grouting, it is important to remove the excesses in a short time and by frequent washing with sponge and water, till the floor is perfectly clean. Then, carry out an acid washing using a single brush with green disks.</p>	<p>SURFACES ANTIDÉRAPANTES</p> <p>Du fait de leur particularité, les surfaces antiglisse, rugueuses ou structurées, sont plus difficiles à nettoyer. Une fois le jointoiment terminé, il est donc important d’enlever rapidement le mortier en excès en procédant à des nettoyages fréquents avec une éponge et de l’eau jusqu’au nettoyage complet du sol. Utiliser ensuite une mono-brosse dotée de disques verts pour effectuer le nettoyage à l’acide.</p>	<p>RUTSCHFESTE OBERFLÄCHEN</p> <p>Aufgrund ihrer Beschaffenheit sind die rutschfesten, rauhen oder strukturierten Oberflächen etwas schwieriger zu reinigen. Nach dem Stucken ist es sehr wichtig, überschüssiges Fugenmaterial möglichst schnell durch wiederholte Reinigungsvorgänge mit einem Schwamm und ausreichend Wasser zu entfernen, bis der gesamte Bodenbelag sauber ist. Danach den Boden mit einem Reinigungsmittel auf Säurebasis mit einer Einscheibenmaschine mit grünen Scheiben reinigen.</p>																												

PULIZIA QUOTIDIANA

DAILY CLEANING | NETTOYAGE QUOTIDIEN | TÄGLICHE REINIGUNG

Utilizzare acqua calda e un panno in microfibra di buona qualità, tipo MAGICCLEAN di Bonasystems Italia. Ogni tanto, ad es. ogni 10-20 giorni a seconda dello stato della pavimentazione, utilizzare detergenti neutri molto diluiti in acqua calda, che non contengono cere o non depositano patine lucide. A fine lavaggio risciacquare sempre con acqua, utilizzando un secondo panno in microfibra di buona qualità.	Use warm water and a good quality microfibre cloth, such as MAGICCLEAN di Bonasystems Italy. Every now and again, e.g. every 10-20 days depending on the state of the flooring, use neutral detergents diluted with hot water, that are wax-free, and do not deposit glossy stains. When the cleaning process is finished always rinse with water, using a second good quality microfibre cloth.	Utiliser de l’eau chaude et un chiffon en microfibre de bonne qualité, type MAGICCLEAN de Bonasystems Italia. De temps en temps, tous les 10-20 jours par ex., et selon l’état du sol, utiliser des détergents neutres très dilués dans de l’eau chaude qui ne contiennent pas de cires et ne laissent pas de tâches brillantes. En fin de lavage, rincer toujours à l’eau et à l’aide d’un chiffon en microfibre de bonne qualité.	Warmes Wasser und ein hochwertiges Mikrofasertuch vom Typ MAGICCLEAN von Bonasystems Italia verwenden. Ab und zu, zum Beispiel alle 10-20 Tage, je nach Zustand des Fußbodenbelags, neutrale in warmen Wasser verdünnte Reinigungsmittel verwenden, die wachsfrei sind und keine glänzenden Schmierfilme hinterlassen. Nach dem Reinigen immer mit Wasser nachspülen und dafür ein zweites hochwertiges Mikrofasertuch verwenden.																																
Si consigliano i seguenti prodotti reperibili in commercio.	The following products, which can be easily found on the market, are recommended.	Les produits conseillés dans le tableau suivant sont disponibles dans le commerce.	Es werden folgende, leicht im Handel erhältliche Mittel empfohlen.																																
<table border="1"> <tr><td>Operazione</td><td>Operation</td><td>Opération</td><td>Vorgang</td></tr> <tr><td>Pulizie quotidiane</td><td>Daily cleaning</td><td>Nettoyage quotidien</td><td>Tägliche Reinigung</td></tr> <tr><td>Tipo di detergente</td><td>Detergent type</td><td>Type de détergent</td><td>Reinigertyp</td></tr> <tr><td>Neutro</td><td>Neutral</td><td>Neutre</td><td>Neutral</td></tr> <tr><td>Nome detergente (Produttore)</td><td>Detergent name (Manufacturer)</td><td>Nom du détergent (Producteur)</td><td>Bezeichnung des Reinigers (Hersteller)</td></tr> <tr><td colspan="4" style="text-align:center">FLOOR CLEANER (FABERCHIMICA) - FILA CLEANER (FILA) - BELGRES (GEAL) - PFLEGEREINIGER (LITHOFIN) - HMK P15 (HMK) BONAMAIN+/BMAIN+ (BONASYSTEMS ITALIA) - BONATTANIA CLEAN/BTTANIA CLEAN (BONASYSTEMS ITALIA)</td></tr> <tr><td>Tipo di Microfibra</td><td>Type of Micro-fiber</td><td>Type de microfibre</td><td>Art der Micro-Faser</td></tr> <tr><td colspan="4" style="text-align:center">MAGIC CLEAN/B CLEAN (BONASYSTEMS ITALIA) o similari/or like products</td></tr> </table>	Operazione	Operation	Opération	Vorgang	Pulizie quotidiane	Daily cleaning	Nettoyage quotidien	Tägliche Reinigung	Tipo di detergente	Detergent type	Type de détergent	Reinigertyp	Neutro	Neutral	Neutre	Neutral	Nome detergente (Produttore)	Detergent name (Manufacturer)	Nom du détergent (Producteur)	Bezeichnung des Reinigers (Hersteller)	FLOOR CLEANER (FABERCHIMICA) - FILA CLEANER (FILA) - BELGRES (GEAL) - PFLEGEREINIGER (LITHOFIN) - HMK P15 (HMK) BONAMAIN+/BMAIN+ (BONASYSTEMS ITALIA) - BONATTANIA CLEAN/BTTANIA CLEAN (BONASYSTEMS ITALIA)				Tipo di Microfibra	Type of Micro-fiber	Type de microfibre	Art der Micro-Faser	MAGIC CLEAN/B CLEAN (BONASYSTEMS ITALIA) o similari/or like products						
Operazione	Operation	Opération	Vorgang																																
Pulizie quotidiane	Daily cleaning	Nettoyage quotidien	Tägliche Reinigung																																
Tipo di detergente	Detergent type	Type de détergent	Reinigertyp																																
Neutro	Neutral	Neutre	Neutral																																
Nome detergente (Produttore)	Detergent name (Manufacturer)	Nom du détergent (Producteur)	Bezeichnung des Reinigers (Hersteller)																																
FLOOR CLEANER (FABERCHIMICA) - FILA CLEANER (FILA) - BELGRES (GEAL) - PFLEGEREINIGER (LITHOFIN) - HMK P15 (HMK) BONAMAIN+/BMAIN+ (BONASYSTEMS ITALIA) - BONATTANIA CLEAN/BTTANIA CLEAN (BONASYSTEMS ITALIA)																																			
Tipo di Microfibra	Type of Micro-fiber	Type de microfibre	Art der Micro-Faser																																
MAGIC CLEAN/B CLEAN (BONASYSTEMS ITALIA) o similari/or like products																																			

PULIZIA STRAORDINARIA

EXTRAORDINARY CLEANING | OPÉRATOINS DE NETTOYAGE EXTRAORDINAIRES | AUSSERORDENTLICHE REINIGUNG

Viene effettuata per rimuovere macchie o residui particolarmente vecchi o resistenti. Nella tabella sotto sono indicati detergenti efficaci a seconda del tipo di macchia.

It is carried out to remove very old or resistant stains or residues. The table below indicates detergents suitable for the stain type.

Ces opérations sont effectuées pour enlever des taches et des résidus particulièrement anciens et résistants. Dans le tableau suivant figure une liste de détergents efficaces, répartis par type de tache.

Diese Reinigung ist im Falle von sehr hartnäckigen oder alten Flecken bzw. Rückständen erforderlich. In der Tabelle sind die für die entsprechenden Flecken geeignetesten Reinigungsmittel aufgelistet.

Residuo da rimuovere Residue to be removed Résidu à enlever Rückstände	Tipo di detergente Detergent type Type de détergent Reingiertyp	Nome detergente (Produttore) Detergent name (Manufacturer) Nom du détergent (Producteur) Bezeichnung des Reinigers (Hersteller)
Grassi, polvere da calpestio, pulizie di fondo Grease, dust footmarks, base cleaning Graises, dépôts de poussières, grands nettoyages Fette, Trittstaub, grundreinigung	Polifunzionali, a base alcalina ⁽¹⁾ Multi-functional, alkali-based ⁽¹⁾ Multifonctionnels, à base alcaline ⁽¹⁾ Mehrzweckreiniger auf Alkalibasis ⁽¹⁾	INTENSIVREINIGER (LITHOFIN) - PS87 (FILA) - HMK R55 (HMK) TASKI R20-strip (JOHNSONDIVERSEY) - BONADECOR BDECON (BONASYSTEMS ITALIA) DETERFLASH (GEAL)
Caffè, Coca Cola, Succhi di frutta, Cere, Grassi, ecc... Coffee, coke, fruit juices, waxes, greases, etc... Café, Coca, jus de fruits, cires, graisses, etc. Kaffee, Coca Cola, Obstsaft, Wachs, Fett usw...	Polifunzionali, a base alcalina ⁽¹⁾ Multi-functional, alkali-based ⁽¹⁾ Multifonctionnels, à base alcaline ⁽¹⁾ Mehrzweckreiniger auf Alkalibasis ⁽¹⁾	COLOURED STAIN REMOVER (FABERCHIMICA) - PS87 (FILA) SUPER DETERJET (GEAL) - CANDEGGINA/BLEACH (Vari produttori Several manufacturers Producteurs divers Verschiedene Hersteller)
Vino Wine Vin Wein	Ossidante Oxidizing Oxydant Oxidationsmittel	OXIDANT (FABERCHIMICA) - CANDEGGINA/BLEACH (Vari produttori Several manufacturers Producteurs divers Verschiedene Hersteller)
Depositi calcarei Calcareous deposits Dépôts de calcaire Kalkab-lagerungen	A base acida ⁽¹⁾ Acid-based ⁽¹⁾ À base acide ⁽¹⁾ Auf Säurebasis ⁽¹⁾	VIKAL (PROCTER & GAMBLE)
Ruggine Rust Rouille Rost	A base acida ⁽¹⁾ Acid-based ⁽¹⁾ À base acide ⁽¹⁾ Auf Säurebasis ⁽¹⁾	ACIDO MURIATICO DILUITO DILUTED HYDROCHLORIC ACID ACIDE MURIATIQUE DILUÉ VERDÜNNTE CHLORWASSER-STOFFSÄURE (Vari produttori Several manufacturers Producteurs divers Verschiedene Hersteller)
Inchiostri, Pennarello Inks, felt pens Encres, feutres Tinten, Filzstift	A base solvente Thinner-based À base solvante Auf Lösungs-mittelbasis	COLOURED STAIN REMOVER (FABERCHIMICA) - DILUENTE NITRO, ACQUARAGIA NITRO THINNER, TURPENTINE DILUANT, TÈREBENTHINE NITROVERDÜNNER, TERPENTIN (Vari produttori Several manufacturers Producteurs divers Verschiedene Hersteller)
Pneumatici, segni di gomma, segni metallici, di matita Tyres, rubber marks, metal or pencil marks Pneus, marques métalliques, de caoutchouc, de crayon Rückstände von Reifen, Gummi, Metall oder Bleistift.	Pasta abrasiva ⁽¹⁾ Abrasive paste ⁽¹⁾ Pâte abrasive ⁽¹⁾ Schleifpaste ⁽¹⁾	VIM CLOREX ⁽²⁾ (GUABER) - POLISHING CREAM ⁽²⁾ (FABERCHIMICA) STRONG REMOVER ⁽³⁾ (FABERCHIMICA) DETERGUM ⁽³⁾ (ZEP ITALIA)
Sporco delle fughe Joint dirt Saleté des joints Fugenschmutz	Specific Specific Spécifique Spezifisch	FUGANET (FILA) - FUGENREINIGER (LITHOFIN)

Per le modalità d’uso seguire le indicazioni specifiche dei fabbricanti.

IMPORTANTE:
⁽¹⁾Fare sempre test preventivi prima dell’uso (su una piastrella non posata), in particolare su prodotti Lappati e Levigati.
⁽²⁾Usare con molta attenzione sui materiali Lappati e Levigati.
⁽³⁾Non usare su prodotti Lappati, usare con molta attenzione sui Levigati.

For the use, follow the specific instructions by the manufacturers.

IMPORTANT:
⁽¹⁾Always make preventive tests before the use (on a tile not laid yet), above all on Lapped or Polished products.
⁽²⁾Exercise extreme caution when using on Lapped and polished materials.
⁽³⁾Do not use on lapped products, and use with great care on polished products.

Pour les modes d’emploi, se conformer aux indications spécifiques fournies par chaque fabricant.

IMPORTANT:
⁽¹⁾Toujours procéder à un essai sur les carreaux rodés ou polis.
⁽²⁾Utiliser avec précaution sur les matériaux Polis et Rodés.
⁽³⁾Ne pas utiliser sur des articles Rodés, utiliser avec prodence sur les articles Polis.

Gebrauchshinweise des Herstellers beachten.

WICHTIG:
⁽¹⁾Von der Benutzung immer erst einen Probeauftrag durchführen, besonders auf geläpften u. polierten.
⁽²⁾Auf geläpftem und poliertem Material mit besonderer Vorsicht verwenden.
⁽³⁾Nicht zum Reinigen geläppter Produkte und nur sehr vorsichtig bei geschliffenen Oberflächen benutzen.

TRATTAMENTI ANTISLIP

ANTI-SLIP TREATMENTS | TRAITEMENT ANTIDÉRAPANT | ANTI-RUTSCH-BEHANDLUNG

La resistenza allo scivolamento dei pavimenti posati (sia piastrelle smaltate che non smaltate) può essere aumentata utilizzando specifici prodotti (vedi tabella).	The resistance of laid floor-tiles (both glazed and unglazed) to slipping can be increased by using specific products (see table).	La résistance des produits antidérapants posés peut être améliorée (carrelage émaillé ou non) à l’aide de produits spécifiques (voir tableau).	Der Gleitwiderstand auf den verlegten Bodenbelägen (sowohl glasierte als auch unglasierte Fliesen) kann mithilfe von entsprechenden Produkten (siehe Tabelle) erhöht werden.
Prima di applicare il prodotto sul pavimento fare test preventivi su piastrelle non posate per trovare i tempi di contatto più idonei. Se da un lato tempi più lunghi aumentano il grado di grip, dall’altro tendono a sbiancare i colori delle piastrelle e a renderle un po’ più sporcabili.	Before applying the product to the floor, do an advance test on unlaid tiles to find the most suitable contact times. On the one hand, longer contact times increase the level of grip, but on the other hand they tend to whiten the colours of the tiles and make them attract dirt a little more.	Avant d’appliquer le produit sur le carrelage, faire un essai sur un carreau non posé afin de déterminer la durée de contact la mieux adaptée. Si des durées plus importantes augmentent l’adhérence, elles décolorent aussi les carreaux et les rendent plus salissants.	Vor dem Auftragen des Produktes auf den Boden empfiehlt es sich, einen Test auf einer noch nicht verlegten Fliese durchzuführen, um so die geeignete Kontaktzeit bestimmen zu können. Während einerseits die Haftfähigkeit durch verlängerte Kontaktzeiten erhöht wird, werden andererseits die Farben der Fliesen ein wenig gebleicht, wodurch diese etwas leichter verschmutzen.

Operazione	Operation	Opération	Vorgang
Trattamenti Antislip	Anti-Slip Treatments	Traitement Antidérapant	Anti-Rutsch-Behandlung
Nome detergente (Produttore)	Detergent name (Manufacturer)	Nom du détergent (Producteur)	Bezeichnung des Reinigers (Hersteller)
BONAGRIP (BONASYSTEMS ITALIA)			

PULIZIA E TRATTAMENTI

CARE AND TREATMENT | NETTOYAGE ET TRAITEMENTS | REINIGUNG UND BEHANDLUNG

RIMOZIONE DI CERE O PATINE LUCIDANTI

REMOVAL OF WAXES OR POLISHING COATS | CIRES OU PRODUITS CIRANTS | ENTFERNEN VON WACHS UND POLIERMITTELN

NON UTILIZZARE CERE SUI PAVIMENTI E RIVESTIMENTI COTTO D'ESTE

DO NOT USE WAXES ON COTTO D'ESTE | NE JAMAIS UTILISER DES CIRES SUR LES REVÊTEMENTS DE SOL ET MURAUX COTTO D'ESTE | AUF COTTO D'ESTE-BODEN- UND -WANDFLIESEN KEINEN WACHS BENUTZEN

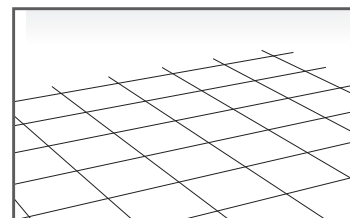

Pavimento nuovo con pulizia dopoposa effettuata come da indicazioni nelle pagine precedenti. New floor that has been cleaned after installation in accordance to the instructions provided on the previous pages.

Nouveau sol avec nettoyage effectué après la pose selon les indications fournies aux pages précédentes. Neuer Boden mit Reinigung nach der Verlegung, die nach den Angaben in den vorausgehenden Seiten erfolgt.

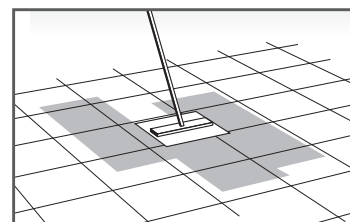

Nella pulizia ordinaria con detergenti contenenti cere, lavaggio dopo lavaggio, si depositano sul pavimento patine lucide. Detergents for routine cleaning that contain wax tend to deposit on the floor and create glossy films.

Le nettoyage ordinaire avec des détergents contenant des cires finit par déposer, lavage après lavage, des patines brillantes sur le sol. Durch die normale Reinigung mit Wachs enthaltenden Reinigungsmitteln bleibt auf dem Boden von Reinigung zu Reinigung eine glänzende Patina zurück.

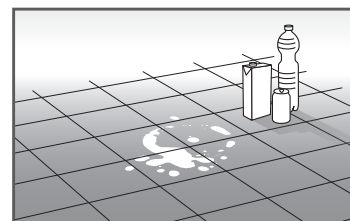

Semplici alimenti (Coca-Cola, vino, acqua...) possono togliere la patina lucida scoprendo la superficie originale più opaca del pavimento. Simple substances (Coca Cola, wine, water, etc.) will remove this glossy film and give the floor its initial matt appearance.

Pour éliminer la patine brillante, utiliser un détergent approprié (Tile Cleaner pur, Faber) et, pour le nettoyage quotidien, un détergent sans cires. Einfache Getränke (Coca Cola, Wein, Wasser usw.) können diese glänzende Patina beseitigen und die ursprüngliche, mattere Fläche freilegen.

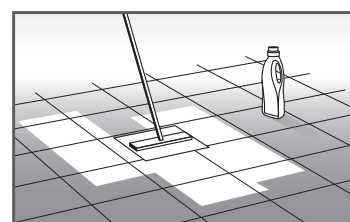

Per rimuovere la patina lucida usare un detergente idoneo (Tile Cleaner puro, Faber) e pulire quotidianamente con un detergente senza cere. To remove the glossy film, use a suitable detergent (undiluted Tile Cleaner by Faber). Daily cleaning should be performed using a detergent that does not contain wax.

Pour éliminer la patine brillante, utiliser un détergent approprié (Tile Cleaner pur, Faber) et, pour le nettoyage quotidien, un détergent sans cires. Zur Entfernung der glänzenden Patina ein geeignetes Reinigungsmittel verwenden (Tile Cleaner pur, Faber), dann täglich ein wachsfreies Reinigungsmittel benutzen.

Capita spesso che nei normali detergenti in commercio siano contenute cere o additivi lucidanti che, lavaggio dopo lavaggio, depositano sul pavimento patine lucide, causa di noie ed alonature. Patine di questo tipo possono essere depositate anche da alcuni stucchi per le fughe. Semplici alimenti come Coca Cola, vino, acqua, ecc..., cadendo sul pavimento tolgono questa patina lucida e ripristinano l'aspetto originale più opaco delle piastrelle. In mezzo al pavimento più lucido, le zone senza cera appaiono come aloni opachi, in realtà sono le uniche parti pulite del pavimento. In questi casi bisogna per prima cosa decerare tutto il pavimento, seguendo le indicazioni della tabella seguente. Poi, per le pulizie ordinarie, utilizzare i detergenti della tabella in basso a pag. 340.

Often, the standard detergents available on the market contain waxes or polishing additives that, washing after washing, deposit glossy coats on the floor causing halos and problems. This kind of coats can be deposited even by some grouts for joints. Simple agents such as coke, wine, water, etc... falling on the floor remove this glossy coat and restore the original duller look of the tiles. Amid a glossier floor, the areas without wax look like dull halos: instead, they are the only clean floor areas. In these cases, first of all the whole floor must be de-waxed, following the indications of the table below. Then, use the detergents of the table below on page 340 for the routine cleaning.

Souvent, les détergents normalement disponibles dans le commerce contiennent des cires ou des additifs cirants qui, nettoyage après nettoyage, forment des couches brillantes sur le carrelage; cela cause des ennuis et produit des auréoles. Ce type de couche peut être causé également par certains coulis utilisés dans les joints. Lorsque des simples boissons, par exemple: le coca-cola, le vin et l'eau, tombent au sol, elles enlèvent la couche brillante et redonnent aux carreaux leur aspect original mat. Les zones opaques au milieu d'un carrelage brillant. En réalité, il s'agit des seules zones propres du sol. Dans ces cas, il faudra tout d'abord décier le sol en se conformant aux instructions contenues dans le tableau suivant. Ensuite, effectuer le nettoyage ordinaire en choisissant un des détergents indiqués à la page 340 en bas.

As kommt oft vor, dass in den herkömmlichen, im Handel erhältlichen Reinigungsmitteln Wachs- oder Poliermittelzusätze enthalten sind, die bei jeder Reinigung glänzende Schichten hinterlassen, welche mit der Zeit störende Schimmer bilden. Ähnliche Schichten können auch durch bestimmte Fugenstücke gebildet werden. Einige weit verbreitete Getränke wie Coca Cola, Wein, Wasser usw... könnten auf dem Boden diese glänzende Schicht entfernen und die wieder das ursprüngliche Aussehen herstellen, das matter ist. Auf einer glänzenden Oberfläche sehen die Bereiche ohne Wachs wie matte Flecken aus. In diesen Fällen muss als erstes der Wachs von der gesamten Bodenfläche entfernt werden. Beachten Sie hierzu die Angaben in der folgenden Tabelle. Für herkömmliche Reinigungen sollten die in der Tabelle unten auf Seite 340 aufgelisteten Reinigungsmittel eingesetzt werden.

Residuo da rimuovere	Residue to be removed	Résidu à enlever	Rückstände
Patine lucide lasciate da detergenti	Glossy coats left by detergents	Couches brillantes laissées par les détergents	Durch Reinigungsmittel gebildete glänzende Schichten
Tipo di detergente	Detergent type	Type de détergent	Reinigertyp
A base acida	Acid-based	À base acide	Auf Säurebasis
Nome detergente (Produttore)	Detergent name (Manufacturer)	Nom du détergent (Producteur)	Bezeichnung des Reinigers (Hersteller)
TILE CLEANER* (puro / pure / pur / unverdünnt) (FABERCHIMICA)			

(*) Non seguire le indicazioni riportate sulla confezione, ma applicare il detergente puro, lasciare agire per 15-30 minuti, frizionare con tamponi morbidi o leggermente abrasivi (bianco, giallo, rosso), poi sciacquare bene con acqua.

(*) Do not follow the indications on the package, rather apply the pure detergent, leave it for 15-30 minutes, rub with soft or lightly abrasive pads (white, yellow, red), then rinse thoroughly with water.

(*) Ne pas suivre les indications fournies sur l'emballage mais utiliser le détergent pur. Laisser agir 15-30 minutes, frictionner avec des tampons souples ou légèrement abrasifs (blanc, jaune et rouge) et rincer à fond avec de l'eau.

(*) Beachten Sie in diesem Falle die auf der Verpackung enthaltenen Hinweise nicht, sondern tragen Sie den Reiniger unverdünnt auf und lassen Sie ihn ca. 15-30 Minuten lang einwirken. Danach mit weichen oder leicht abrasiven Puffern (weiß, gelb, rot) nachbehandeln und dann gut mit Wasser spülen.

RIFERIMENTI UTILI

USEFUL REFERENCES | INFORMATIONS UTILES | MEHR INFORMATIONEN

MAPEI Spa, via Cafiero 22, 20158 Milano - Italy - Tel. +39.02.37673 - www.mapei.it

FABERCHIMICA Srl, via G. Ceresani 10 - loc. Campo d'Olmo 60044 Fabriano (AN) - Italy - Tel. +39.0732.627178 - www.faberchimica.com

FILA Industria Chimica Spa, via Garibaldi 32, 35018 S. Martino dei Lupari (PD) - Italy - Tel. 049.9467300 - www.filachim.it

ZEP Italia Srl, via Nettunese Km 25,000 - 04011 Aprilia (LT) - Italy - Tel. 06.926691 - www.zepitalia.it

BONASYSTEMS ITALIA Srl, via Borgo Santa Chiara, 29 - 30020 Torre di Mosto (VE) - Italy - Tel. +39.0421.325691 - www.bonasyntemia.it

WONDERWALL

CARATTERISTICHE TECNICHE DEL PRODOTTO IN PRIMO FUOCO

TECHNICAL CHARACTERISTICS OF SINTERED PRODUCTS | CARACTÉRISTIQUES TECHNIQUES DU PRODUIT EN PREMIÈRE CUISSON | TECHNISCHE MERKMALE DES PRODUKTS BEI ERSTBRENNUNG

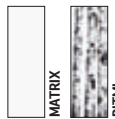

MASSA E DECORAZIONE BODY AND DECORATION MASSA ET DÉCORATION MASSE UND DEKORATION		Bla UGL - Realizzato in primo fuoco con decorazione Ink-Jet in linea.	Bla UGL - Sintered with printed using ink-jet decorations.	Bla UGL - Réalisé en première cuisson avec décoration à jet d'encre en ligne.	Bla UGL - Realisiert mit Erstbrennung und Aserienmäßiger Ink-Jet-Dekoration.
DESTINAZIONE D'USO INTENDED USES DOMAINES D'EMPLOI VERWENDUNGSZWECKE		Idonei per la posa a parete in interno ed esterno e per la posa a pavimento in ambito residenziale e pubblico.	Suitable for the cladding of both interior and exterior walls and for residential and public flooring.	Approprié pour la pose au mur à l'intérieur ou à l'extérieur et pour la pose au sol dans le domaine résidentiel et public.	Geeignet für die Wandverlegung im Innen- und Außenbereich und für die Fußbodenverlegung im Wohn- und öffentlichem Bereich.
RESISTENZA ALLA FLESSIONE - Valore medio BENDING STRENGTH - Average value RÉSISTANCE À LA FLEXION - Valeur moyenne BIEGUNGSBESTÄNDIG - Durchschnittswert	ISO 10545-4	50 N/mm ²			
RESISTENZA ALL'ABRASIONE PROFONDA - Valore medio DEEP ABRASION RESISTANCE - Average value RÉSISTANCE À L'ABRASION PROFONDE - Valeur moyenne SCHEUERFESTIGKEIT IN DER TIEFE - Durchschnittswert	ISO 10545-6	175 mm ³			
RESISTENZA AGLI SBALZI TERMICI THERMAL SHOCK RESISTANCE RÉSISTANCE AUX CHOCS THERMIQUES TEMPERATURWECHSELBESTÄNDIGKEIT	ISO 10545-9	RESISTENTE / RESISTANT			
RESISTENZA ALLE MACCHIE STAIN RESISTANCE RÉSISTANCE AUX TACHES FLECKENBESTÄNDIGKEIT	ISO 10545-14	5 RESISTENTE / 5 RESISTANT			
RESISTENZA DEI COLORI ALLA LUCE RESISTANCE OF COLOURS TO LIGHT RÉSISTANCE DES COULEURS À LA LUMIÈRE FARBBESTÄNDIGKEIT GEGEN SONNENEINSTRALHUNG	DIN 51094	Superficie inalterata	Surface unaltered	Surface inaltérée	Unveränderte Oberfläche
RESISTENZA ALL'ATTACCO CHIMICO RESISTANCE TO CHEMICAL ETCHING RÉSISTANCE À L'ATTAQUE CHIMIQUE BESTÄNDIGKEIT GEGEN CHEMISCHEN ANGRIFF	ISO 10545-13	LA-HA			
ASSORBIMENTO D'ACQUA - Valore medio WATER ABSORPTION - Average value ABSORPTION D'EAU - Valeur moyenne WASSERAUFNAHME - Durchschnittswert	ISO 10545-3	0,1%			
RESISTENZA AL GELO FROST RESISTANCE RÉSISTANCE AU GEL FROSTBESTÄNDIGKEIT	ISO 10545-12	RESISTENTE / RESISTANT			
STONALIZZAZIONE DESHADING NUANÇAGE FARBABWEICHUNG	ANSI A137.3	V1			

AVVERTENZE PER LA POSA E LA PULIZIA

WARNINGS FOR LAYING AND CLEANING | MISES EN GARDE POUR LA POSE ET LE NETTOYAGE | HINWEISE ZUR VERLEGUNG UND REINIGUNG

POSA INSTALLATION POSE VERLEGUNG	Se posati a pavimento o in esterno è necessario fare la doppia spalmatura di colla: una sul fondo e l'altra nel retro della lastra.	If used for flooring or in an exterior space double buttering with adhesive is necessary: one on the base and the other on the back of the slab.	Si posés au sol ou à l'extérieur, une double application de colle est nécessaire: une sur le support et l'autre au dos de la dalle.	Bei Fußbodenverlegung oder im Außenbereich muss der Kleber doppelseitig aufgetragen werden. Sowohl auf dem Untergrund als auch auf der Rückseite der Platte.
STUCCATURA GROUTING REMPLISSAGE DES JOINTS VERSPACHTELN	Si possono utilizzare sia stucchi epossidici che stucchi cementizi.	Both cementitious and epoxy grouting products can be used.	Il est possible d'utiliser aussi bien des mortiers de jointoiment époxydiques que des mortiers de jointoiment de ciment.	Es können sowohl Epoxyd- als auch Zementspachtel eingesetzt werden.
PULIBILITÀ CLEANING ENTRETIEN PFLEGE	<p>VISIBILITÀ DELLE IMPRONTE (Metodo Cotto d'Este) TREAD MARK VISIBILITY (Cotto d'Este method) VISIBILITÉ DES EMPREINTES (Méthode Cotto d'Este) SICHTBARKEIT DER ABDRÜCKE (Méthode Cotto d'Este)</p> <p>A - Impronta non visibile Tread mark not visible Empreinte non visible Unsichtbarer Abdruck</p> <p>FACILITÀ DI PULIZIA (Metodo Cotto d'Este) CLEANING EASINESS (Cotto d'Este method) FACILE À ENTRETIEN (Méthode Cotto d'Este) EINFACHE REINIGUNG (Méthode Cotto d'Este)</p> <p>1 - Molto facile, nessuna resistenza dello sporco, rimozione immediata Very easy, no resistance of the dirt, immediate removal Très facile, aucune résistance de la saleté, retrait immédiat Sehr einfach, Schmutz frisst sich nicht fest, sofortiges Entfernen</p>			
TAGLIO E FORO CUTTING AND DRILLING DÉCOUPE ET PERÇAGE SCHNEIDEN UND BOHREN	Utilizzare tagliavetro tipo Silberschnitt 2000, tagliapiastrelle da banco per lastre in gres, smerigliatrici flex con dischi diamantati, idrogetto o altri strumenti tradizionali per il taglio del gres porcellanato. Per il foro utilizzare trapano senza percussione con punta di tungsteno bagnandola ripetutamente con acqua.	Use a Silberschnitt 2000-type glass cutter, counter top tile cutter for stoneware slabs, angle grinders with diamond disks, water jet, or other traditional tools for cutting porcelain stoneware. To drill use a non-hammer drill with a tungsten drill bit and wet it repeatedly with water.	Pour ces opérations utiliser un coupe-verre type Silberschnitt 2000, une machine à couper les carreaux d'ébâti pour dalle en grès, disqueuse avec disques diamantés, hydrojet ou autres instruments traditionnels pour la coupe du grès cérame. Pour le trou, utiliser une perceuse sans percusion équipée d'une mèche au tungstène, en la mouillant plusieurs fois avec de l'eau.	Verwenden Sie Schneider vom Typ Silberschnitt 2000, Messerbank für Feinsteinzeugplatten, Flexschleifer mit Diamantscheiben, Jet oder andere traditionelle Werkzeuge zum Schneiden von Feinsteinzeug. Für die Lochbohrung keinen Schlaghammer verwenden, sondern einen Bohrer mit Wolframspitze und beim Bohren wiederholt mit Wasser benetzen.

Per approfondimenti ed ulteriori informazioni consultare il manuale tecnico Kerlite sul nostro sito internet o presso il nostro rivenditore | To more details and for additional information please consult the Kerlite technical manual available on our website or through our authorized dealers | Pour des approfondissements et des informations supplémentaires, consulter le manuel technique Kerlite sur notre site internet ou auprès de notre revendeur | Für weitere Details und Informationen lesen Sie das technische Handbuch Kerlite, welches auf unserer Webseite oder bei Ihrem Händler zur Verfügung steht.

CARATTERISTICHE TECNICHE DEL PRODOTTO DECORATO CON TECNOLOGIA A FREDDO

TECHNICAL CHARACTERISTICS OF PRODUCTS DECORATED WITH COLD DECORATING TECHNOLOGY | CARACTÉRISTIQUES TECHNIQUES DU PRODUIT DÉCORÉ AVEC TECHNOLOGIE À FROID | TECHNISCHE MERKMALE DES MIT DER KALTTECHNOLOGIE DEKORIERTEN PRODUKTS

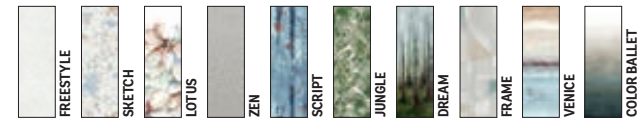

Bla GL - Decorata mediante la nuova tecnologia di stampa digitale a freddo su supporto in Kerlite 3plus.	Bla GL - Decorated using a new cold digital printing technology on Kerlite 3plus.	Bla GL - Décoré grâce à la nouvelle technologie d'impression numérique à froid sur support en Kerlite 3plus.	Bla GL - Dekoriert mit der neuen Digitaltaltdruck-Technologie auf Träger Kerlite 3plus.				
	Idonei esclusivamente per la posa a parete in ambienti interni; non posare a pavimento e a rivestimento in luoghi esterni.	Intended exclusively for the cladding of interior walls; do not use as flooring or to clad exterior spaces.	Approprié exclusivement pour la pose au mur dans les environnements intérieurs; ne pas poser au sol et en revêtement dans les environnements extérieurs.	Geeignet ausschließlich für die Wandverlegung in Innenbereichen; nicht für das Verlegen von Fußböden und Wandverkleidung im Außenbereich geeignet.			
La decorazione di questi prodotti non ha una buona resistenza ai graffi di oggetti acuminati molto duri come ad esempio metallo, pietra, vetro e gres. Prestare la massima attenzione alla movimentazione durante le operazioni di posa evitando di urtare o strisciare utensili ed oggetti duri acuminati sulla superficie.		This product's decoration is not scratch resistant to hard, sharp objects such as metal, stone, glass, and stoneware. Be extremely careful when handling the product during installation, making sure not to bump or slide tools or other sharp objects against the surface.		La décoration de ces produits ne résiste pas bien aux rayures causées par les objets pointus et très durs tels que le métal, la pierre, le verre ou le grès, entre autres. Faire particulièrement attention à la manipulation au cours des opérations de pose, en évitant de heurter ou de faire glisser les outils et les objets durs et pointus sur la surface.		Die Dekoration dieser Produkte ist nicht sehr widerstandsfähig gegen Kratzer durch sehr harte spitze Gegenstände, zum Beispiel aus Metall, Stein, Glas und Feinsteinzeug. Fahren Sie bei der Handhabung der Platten während der Verlegung besonders vorsichtig fort und vermeiden Sie Stöße oder Kratzer auf der Oberfläche durch Werkzeuge oder andere harte Gegenstände.	
Resiste alle macchie di alimenti e bevande conforme alla classe 5. Non resiste alla tintura di iodio, blu di metilene, pennarello indelebile.		Class-5 resistance to food and beverage stains. Not resistant to iodine dye, methylene blue, or permanent marker.		Résiste aux taches d'aliments et boissons conforme à la classe 5. Ne résiste pas à la teinture d'iode, bleu de méthylène, feutre indélébile.		Fleckenbeständig gegen Lebensmittel- und Getränkeflecken, konform mit Klasse 5 Nicht beständig gegen Jodfarben, Methylenblau, Permanentmarker.	
Superficie inalterata		Surface unaltered		Surface inaltérée		Unveränderte Oberfläche	
				LA-HB			
						0,1%	
				RESISTENTE RESISTANT			
						V1	

Spalmare la colla con spatola dentata di almeno 5mm sul fondo della parete ed applicare la lastra a muro. Non è necessaria la doppia spalmatura tuttavia per una adesione ancor più tenace suggeriamo di stendere sulla stuoia in fibra di vetro posta sul retro della lastra un velo sottile di colla e spalmarla con una spatola piatta. Battere bene la lastra con spatola gommatata al fine di allineare perfettamente le lastre fra di loro. Non usare distanziatori livellanti. Si consiglia la fuga di 1mm fra una lastra e l'altra.	Spread the adhesive using a notched trowel (of at least 5 mm) on the base of the wall and apply the slab. Double buttering is not necessary, however for an even stronger hold we recommend using a flat trowel to spread a thin layer of glue on the fiberglass mesh on the back of the slab. Use a rubber trowel to tap the slabs, making sure that they are perfectly in line with one another. Do not use levelling spacers. A grout width of 1 mm between slabs is recommended.	Étaler le mortier-collé sur le mur à l'aide d'un peigne crantée d'au moins 5 mm, puis appliquer dessus la dalle au mur. Il n'est pas nécessaire de faire un double encollage mais cependant, pour une adhérence encore plus tenace, nous suggérons d'étaler sur la natte en fibre de verre située au dos de la dalle une fine couche de mortier-collé et de l'étendre à l'aide d'une spatule plate. Bien tapoter les dalles à l'aide d'une spatule en caoutchouc afin de les aligner parfaitement les unes avec les autres. Ne pas utiliser de croisillons de nivellement. Il est conseillé de faire un joint de 1 mm entre une dalle et l'autre.	Den Kleber mit dem Zahnspachtel von mindestens 5 mm auf dem Wanduntergrund auftragen und die Platte an der Wand ankleben. Die doppelseitige Verspachtelung ist nicht notwendig, dennoch wird für eine verstärkte Haftung empfohlen, die auf der Rückseite der Platte befindliche Glasfasermatte mit einer dünner Kleberschicht mit Hilfe eines Flachspachtel zu verstreichen. Die Platte mit einem Gummispachtel fest anklopfen und die Platten untereinander ausrichten. Keine nivellierenden Abstandstücke verwenden. Es wird die Ausführung von 1 mm breiten Fugen empfohlen.
Utilizzare solo stucchi cementizi, non usare stucchi epossidici.	Use only cementitious grout, not epoxy grout.	Utiliser seulement des mortiers de jointoiment de ciment, ne pas utiliser de mortiers de jointoiment époxydiques.	Die Fugen nur mit Zementmörtel verfügen; keine Epoxyd-Mörtel verwenden.
Utilizzare acqua o detersivi o sgrassatori neutri generici in vendita nei comuni negozi. Non utilizzare alcol, acetone e solventi in genere.	Use water or generic neutral detergents or degreasers available over the counter in general stores. Do not use alcohol, acetone, or solvents in general.	Utiliser de l'eau ou des détergents et dégraissants neutres génériques en vente dans les magasins. Ne pas utiliser d'alcool, acétone et solvants en poudre.	Verwenden Sie Wasser oder neutrale im Handel erhältliche Reinigungs- bzw. Entfettungsmittel. Kein Alkohol, Aceton oder Lösungsmittel im Allgemeinen verwenden.
È essenziale lavorare su una superficie planare e pulita. Il materiale può essere tagliato bene solo utilizzando smerigliatrice flex con disco diamantato sottile montato sulla guida della macchina da taglio oppure a mano. Prestare la massima attenzione alla movimentazione durante le operazioni di posa evitando di urtare o strisciare utensili ed oggetti duri acuminati sulla superficie. Per il foro utilizzare trapano senza percussione con punta di tungsteno bagnandola ripetutamente con acqua.	It is essential to work on a flat, clean surface. The material can be cut well only using an angle grinder with a thin diamond disk mounted on the cutting machine's guide or by hand. Be extremely careful when handling the product during installation, making sure not to bump or slide tools or other sharp objects against the surface. To drill use a non-hammer drill with a tungsten drill bit, and wet it repeatedly with water.	Il est essentiel de travailler sur une surface plane et propre. Le matériau est uniquement bien coupé si l'on utilise une disqueuse avec disque diamanté fin monté sur le guide de la machine à couper ou à la main. Faire particulièrement attention à la manipulation au cours des opérations de pose, en évitant de heurter ou de faire glisser les outils et les objets durs et pointus sur la surface. Pour le trou, utiliser une perceuse sans percusion équipée d'une mèche au tungstène, en la mouillant plusieurs fois avec de l'eau.	Es ist grundlegend auf einer ebenen und sauberen Oberfläche zu arbeiten. Das Material kann nur unter Verwendung von Flexschleifer mit einer dünnen an der Führung der Schneidmaschine montierten Diamantklinge oder von Handgeschritten werden. Fahren Sie bei der Handhabung der Platten während der Verlegung besonders vorsichtig fort und vermeiden Sie Stöße oder Kratzer auf der Oberfläche durch Werkzeuge oder andere harte Gegenstände. Für die Lochbohrung keinen Schlaghammer verwenden, sondern einen Bohrer mit Wolframspitze und beim Bohren wiederholt mit Wasser benetzen.

CERTIFICAZIONI

CERTIFICATIONS | CERTIFICATIONS | ZERTIFIKATE

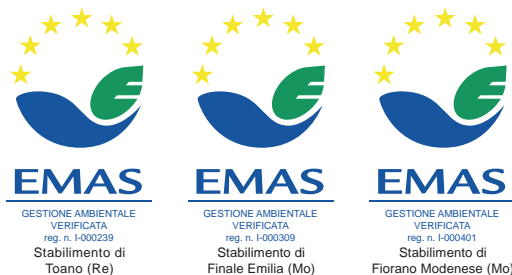

CERTIFICAZIONI AMBIENTALI EMAS DEI SITI PRODUTTIVI

EMAS APPROVED ENVIRONMENTAL MANAGEMENT SYSTEM OF PRODUCTION SITES | SYSTÈME DE MANAGEMENT ENVIRONNEMENTAL CERTIFICAT EMAS DES SITES DE PRODUCTION | UMWELTZERTIFIZIERUNG EMAS DER PRODUKTIONSSTÄTTEN

Il sistema comunitario di ecogestione ed audit EMAS è lo strumento con cui l'Unione Europea promuove il miglioramento continuo delle prestazioni ambientali delle organizzazioni - rif. Regolamenti (CE) 1221/2009 e (UE) 2017/1505 del Parlamento Europeo e del Consiglio. Cotto d'Este ha ottenuto la registrazione EMAS per tutti i suoi siti produttivi di Toano (RE) (N. registrazione I-000239 del 30/09/2004), Finale Emilia (MO) (N. registrazione I-000309 del 14/04/2005) e Fiorano Modenese (MO) (N. registrazione I-000401 del 15/12/2005). Questa registrazione riveste una grande importanza, perché impone la creazione di un vero Sistema di Gestione Ambientale basato sul continuo miglioramento delle proprie prestazioni ambientali. Il sistema si basa sulla creazione di un rapporto di collaborazione e fiducia con le istituzioni del territorio (Enti, Autorità, Associazioni, Rappresentanze Sindacali, Scuole, Stampa) e con il pubblico, ed è prevista la partecipazione attiva di tutti i dipendenti. La Dichiarazione Ambientale è il documento finale che descrive gli aspetti ambientali e di sicurezza sul lavoro, le prestazioni ambientali del sito e gli obiettivi ambientali che l'Azienda si impone di raggiungere nell'ottica del miglioramento continuo. La dichiarazione è convalidata da un Verificatore Ambientale Accreditato a seguito verifiche ispettive (audit) eseguite in stabilimento. Cotto d'Este è tra le pochissime aziende ceramiche ad avere la registrazione EMAS, che, insieme alla ECOLABEL ed alla Certificazione Qualità ISO 14001, testimonia la massima attenzione e sensibilità del management alle questioni etiche, ambientali, di sicurezza e qualità.

The Community Eco-Management and Audit Scheme (EMAS) is the tool through which the European Union promotes continuous improvement of the environmental performance of organizations - ref. Regulations (CE) 1221/2009 and (UE) 2017/1505 of the European Parliament and Council. Cotto d'Este has obtained EMAS Registration for all its production sites: Finale Emilia (MO) (registration n.I-000309 on April 2005), Toano (RE) (registration n.I-000239 on September 2004) and Fiorano Modenese (MO) (registration n.I-000401 on December 2005). This registration is of major importance, since it requires a proper Environmental Management System to be created, based on the continual improvement of environmental performance within organisations. The scheme is based on the creation of an open dialogue with local institutions (Agencies, Authorities, Associations, Trade Union Representatives, Schools, Press) and with the public, and it is expected that all employees will play an active part. The Environmental Statement is the end document that describes the environmental and safety aspects in the workplace, the environmental performance of the site and the environmental targets that the Company sets itself within the framework of continual improvement. The statement is validated by an Accredited Environmental Verifier, following audits carried out in the plant. Cotto d'Este is one of the very few ceramics companies to have EMAS registration which, together with the ECOLABEL and ISO 14001 quality certification, bear witness to the management's utmost commitment and readiness to engage with the ethical, environmental, safety and quality issues.

Le Système communautaire de Management environnemental et d'Audit est un instrument employé par l'Union européenne pour promouvoir l'amélioration constante des performances environnementales des organisations. — Référence : Règlements (CE) n° 1221/2009 et (UE) 2017/1505 du Parlement européen et du Conseil. Cotto d'Este a obtenu l'accréditation EMAS pour les trois sites de production: Finale Emilia (MO) (accréditation n.I-000309 pendant Avril 2005), Toano (RE) (accréditation n.I-000239 pendant Septembre 2004) et Fiorano Modenese (MO) (accréditation n.I-000401 pendant Décembre 2005). Cette certification revêt une grande importance, car elle sous-entend la création d'un véritable Système de gestion de l'environnement, basé sur la perpétuelle amélioration des résultats obtenus en matière d'environnement. Le système repose sur la création d'un rapport de collaboration et de confiance avec les institutions du territoire (Institutions, Pouvoirs publics, Associations, Représentations syndicales, Écoles, Presses) et avec le public. Il est prévu que tous les employés participeront activement à ce programme. La déclaration environnementale constitue le document final décrivant les éléments en matière d'environnement et de sécurité sur le lieu de travail, les efforts effectués par le site pour l'environnement et les objectifs que l'entreprise s'est fixés dans le cadre de cette amélioration perpétuelle. La déclaration a été validée par un Contrôleur officiel suite aux inspections (audit) effectuées sur le site. Cotto d'Este fait partie des rares entreprises actives dans le domaine de la céramique disposant du certificat EMAS, qui, à l'instar de l'ECOLABEL et du certificat de qualité ISO 14001, témoigne de la plus grande attention et de la sensibilité de la part de la direction en ce qui concerne les questions éthiques, environnementales, de sécurité et de qualité.

Das Gemeinschaftssystem für Umweltmanagement und Umweltbetriebsprüfung EMAS ist das Instrument, mit dem die Europäische Union die kontinuierliche Verbesserung der Umweltleistung von Organisationen fördert - vgl. Verordnungen (EG) Nr. 1221/2009 und (EU) 2017/1505 des Europäischen Parlaments und des Rats. Cotto d'Este ha die EMAS Registrierung für alle Produktionsstätten erhalten: Toano (RE) (Registrierungsnummer I-000239 vom 30/09/2004), Finale Emilia (MO) (Registrierungsnummer I-000309 vom 14/04/2005) und Fiorano Modenese (MO) (Registrierungsnummer I-000401 vom 15/12/2005). Diese Registrierung hat eine große Bedeutung, da sie die Schaffung eines wahren Umweltmanagement - systems auf der Grundlage der kontinuierlichen Verbesserung der Effizienz des Umweltcontrollings impliziert. Das System basiert auf dem Aufbau einer kooperativen und von gegenseitigem Vertrauen geprägten Beziehung mit den territorialen Institutionen (öffentlichen Einrichtungen, Behörden, Verbänden, gewerkschaftlichen Vertretungen, Schulen, Presse) und der Öffentlichkeit. Des Weiteren ist die aktive Einbeziehung des gesamten Personals vorgesehen. Die Umweltschutzerklärung ist das endgültige Dokument, in dem die Aspekte zum Umweltschutz und zur Sicherheit am Arbeitsplatz, die Initiativen zum Schutz der Umwelt an diesem Standort sowie die Ziele beschrieben werden, die das Unternehmen im Rahmen des kontinuierlichen Verbesserungsprozesses erreichen will. Die Erklärung wird von einem zugelassenen Umweltgutachter nach vor Ort durchgeführten Inspektionen (Audits) genehmigt. Cotto d'Este ist einer der wenigen Keramikhersteller, der eine EMAS-Registrierung vorweisen kann, die, gemeinsam mit ECOLABEL und dem Qualitätszertifikat ISO 14001, das große Engagement und die Sensibilität des Unternehmens in bezug auf Ethik, Umweltschutz, Sicherheit und Qualität unter Beweis stellt.



LEED CREDITI LEED V4 LEED V4 CREDITS | CRÉDITS LEED V4 | KREDITE LEED V4

Cotto d'Este è membro del U.S. Green Building Council e del Green Building Council ITALIA, organizzazioni che promuovono la realizzazione di edifici ed opere nel rispetto dell'ambiente, della salute e del benessere delle persone che ci vivono e lavorano. LEED V4 nasce da U.S. Green Building Council per offrire a progettisti, architetti e costruttori uno nuovo strumento per realizzare edifici secondo standard più esigenti in termini di sostenibilità, salubrità e vivibilità. Anche per i materiali da costruzione, tra cui le piastrelle di ceramica, vengono richiesti requisiti più severi e più completi, tra cui anche la Dichiarazione Ambientale EPD. **Le schede LEED delle serie Cotto d'Este sono disponibili su richiesta, sia secondo il protocollo LEED V4 che secondo i protocolli del GBC Italia.**

EPD - Dichiarazione Ambientale di Prodotto

La Dichiarazione Ambientale di Prodotto (EPD) comunica in modo trasparente le prestazioni ambientali del gres porcellanato Cotto d'Este basandosi sull'analisi del ciclo di vita (LCA). Si tratta di una EPD media di settore, certificata nell'ottobre 2016 da un Ente indipendente di terza parte secondo regole ufficiali (PCR), richiesta dai principali sistemi di certificazione degli edifici quali LEED (internazionale), BREEAM (Inghilterra), HQE (Francia) e DGNB (Germania), nonché in schemi legislativi in Italia (requisiti per appalti pubblici sostenibili). E' una certificazione volontaria, che valorizza ancor più i materiali Cotto d'Este perché prodotti secondo i migliori standard di sostenibilità e responsabilità.

Cotto d'Este is a member of the U.S. Green Building Council and of the Green Building Council ITALIA. These organizations promote the construction of buildings and other works which respect the environment as well as the health and well-being of the people who live and work within them. LEED V4 was created by the U.S. Green Building Council to provide designers, architects, and builders with a new tool for the construction of buildings that adhere to more elevated standards of sustainability, health, and liveability. More stringent and thorough requisites are required of building materials, like ceramic tiles, including the Environmental Product Declaration (EPD). **The LEED data sheets for Cotto d'Este are available upon request, according to both the LEED V4 and GBC Italia protocols.**

EPD - Environmental Product Declaration

The Environmental Product Declaration (EPD) is a transparency tool that communicates the environmental performances of Cotto d'Este porcelain tile through a Life Cycle Assessment (LCA). This is a Sector-wide EPD, certified in October 2016 by an independent third party according to official guidelines (PCR), requested by the primary building certification systems such as LEED (international), BREEAM (England), HQE (France), and DGNB (Germany), as well as the legislative frameworks in Italy (requisites for sustainable public contracts). It is a voluntary certification that gives additional value to Cotto d'Este products because they are manufactured according to the highest standards of sustainability and responsibility.

Cotto d'Este est membre de l'U.S. Green Building Council et du Green Building Council d'Italie. Ces organisations promeuvent la réalisation de bâtiments et de travaux qui respectent l'environnement, la santé et le bien-être des personnes qui travaillent à la réalisation et de celles pour lesquelles elle est destinée. LEED V4 a été créé par U.S. Green Building Council pour offrir aux designers, architectes et constructeurs, un nouvel outil capable de répondre aux dernières exigences de réalisation en termes de durabilité, salubrité et bien-être. Pour les matériaux de construction, tels que les carreaux en céramique, les exigences sont encore plus sévères et plus complètes, et doivent être accompagnés notamment d'une Déclaration Environnementale Produit (DEP). **Les fiches LEED des séries Cotto d'Este sont disponibles sur demande, selon le protocole LEED V4 ainsi que selon les protocoles GBC Italie.**

DEP - Déclaration Environnementale Produit

La Déclaration Environnementale Produit (DEP) communique de manière transparente les performances environnementales du gres cérame Cotto d'Este en se basant sur l'analyse du cycle de vie (ACV). Il s'agit d'une DEP par secteur, certifiée en octobre 2016 par une Autorité indépendante de tierce partie, selon les normes officielles (Règles des Catégories de Produits) requises par les principaux systèmes de certification des bâtiments tels que LEED (pour l'international), BREEAM (Angleterre), HQE (France) et DGNB (Allemagne), et par les cadres législatifs prévus en Italie (conditions pour participer aux marchés publics durables). Cette certification est une démarche volontaire, et vise à apporter une valeur supplémentaire aux matériaux Cotto d'Este, fabriqués de manière responsable et selon les meilleurs standards écologiques.

Cotto d'Este ist ein Mitglied des US-Green Building Councils und des Green Building Councils ITALIA, beides Organisationen, die den Bau von Gebäuden und Strukturen unter Beachtung der Umwelt, Gesundheit und des Wohlbefindens der Menschen, die darin leben und arbeiten fördern. LEED V4 ist ein Projekt des U.S. Green Building Councils, um Designern, Architekten und Konstrukteuren ein neues Instrument zu liefern, Gebäude gemäß den anspruchsvollsten Standards in Bezug auf Nachhaltigkeit, Gesundheit und Lebensqualität zu realisieren. Auch für Baumaterialien, einschließlich keramischer Fliesen, werden strengere und vollständiger Anforderungen, einschließlich der Umwelterklärung EPD verlangt. **Die LEED-Karten der Serie Cotto d'Este sind auf Anfrage erhältlich, sowohl gemäß dem Protokoll LEED-V4 als auch gemäß den Protokollen des GBC Italien.**

EPD - Die Umwelt-Produktdeklaration

Die Umwelt-Produktdeklaration (EPD) teilt in einer transparenten Art und Weise die Umweltleistung von Feinsteinzeug Cotto d'Este auf der Grundlage der "Lebenszyklusanalyse" (LCA) mit. Es handelt sich um eine branchenweite EPD, zertifiziert im Oktober 2016 durch eine unabhängige dritte Partei nach offiziellen Regeln (PCR), die von den wichtigsten Zertifizierungssystemen für Gebäude, wie LEED (International), BREEAM (England), HQE (Frankreich) und DGNB (Deutschland), sowie in Gesetzgebungsregelungen in Italien (Anforderungen für nachhaltige öffentliche Beschaffung) verlangt wird. Es ist eine freiwillige Zertifizierung, die die Materialien Cotto d'Este Produkte weiter aufwertet, da sie nach den höchsten Standards der Nachhaltigkeit und Verantwortung produziert werden.

CERTIFICAZIONI

CERTIFICATIONS | CERTIFICATIONS | ZERTIFIKATE



RECICLED CERAMIC CONTENT | CONTENUTO DI MATERIALE RICICLATO AL 40%

40% OF RECYCLED MATERIAL | LE CONTENU EN MATÉRIEL RECYCLÉ EST DE 40% | GEHALT AN RECYCLING-MATERIAL 40%

Le serie Cotto d'Este contrassegnate da questo marchio sono studiate per riutilizzare nell'impasto ceramico materiale riciclato proveniente da altri processi produttivi. Questo si traduce in un minore utilizzo di risorse naturali ed un maggior rispetto per l'ambiente.

The Cotto d'Este series with this label contain recycled material resulting from other production processes. This means reduced use of natural resources and more respect for the environment.

Les séries Cotto d'Este sur lesquelles cette marque est apposée sont étudiées pour permettre de réutiliser dans le mélange céramique du matériel recyclé issu d'autres processus de production. Cette solution permet de réduire l'utilisation de ressources naturelles et d'augmenter le respect pour l'environnement.

Die mit diesem Markenzeichen versehene Serien von Cotto d'Este wurden ausgearbeitet, um in der Keramikmischung aus anderen Produktionsprozessen kommendes Recyclingmaterial wieder zu verwenden. Das bedeutet einen geringeren Verbrauch von natürlichen Ressourcen und mehr Berücksichtigung der Umwelt.



KEY MARK E UNI-CERTIQUALITY

GARANZIA DI QUALITÀ PER IL CONSUMATORE

KEY MARK AND UNI-CERTIQUALITY A GUARANTEE OF QUALITY FOR THE CONSUMER | KEY MARK ET UNI-CERTIQUALITY GARANTIE DE QUALITÉ POUR LE CONSOMMATEUR | KEY MARK UND UNI-CERTIQUALITY: QUALITÄTSSICHERUNG FÜR DEN VERBRAUCHER

Dal 1996 Panaria ha richiesto ed ottenuto la certificazione UNI, marchio rilasciato dall'Ente Nazionale di Certificazione (membro CEN Comitato Europeo di Normazione). Dal 2006, inoltre, ha richiesto ed ottenuto il Marchio di Qualità Europeo di prodotto KEY MARK rilasciato dal CEN. Il marchio KEY MARK ed il marchio UNI-Certiquality attestano che i prodotti certificati sono conformi alle normative europee EN 14411 per le piastrelle ceramiche. I prodotti certificati sono specificati nell'apposita tabella di questa sezione.

Panaria applied for and obtained UNI approval, a stamp issued by the National Standards Body (member of CEN, European Committee for Standardization) since 1996. Panaria applied for and obtained also KEY MARK, Mark of Quality European of product approval of CEN since 2006. The KEY MARK and the UNI-Certiquality mark verifies that the approved products conform with EN 14411 European regulations for ceramic tiles. Approved products are specified in the appropriate table of this technical section.

A partir de 1996, l'entreprise Panaria a demandé et obtenu la certification UNI, label délivré par l'Autorité Nationale de Certification (membre CEN Comité Européen de Normalisation). A partir de 2006, l'entreprise Panaria a demandé et obtenu aussi la certification le KEY MARK, Label de Qualité Européenne de produit délivré par le CEN. Les marques KEY MARK et UNI-Certiquality attestent que les produits certifiés sont conformes aux normes européennes EN 14411 pour les carreaux céramiques. Les produits certifiés figurent dans le tableau appropriée de cette section technique.

Seit 1996 besitzt das Unternehmen Panaria die UNI Zertifizierung, die vom italienischen Institut für Normung, Italienischer Nationalverband für Zertifizierungen, (Mitglied des Europäischen Komitees für Normung CEN) ausgestellt wird. Seit 2006 besitzt das Unternehmen Panaria die KEY MARK Zertifizierung, Europäischen Qualitätsmark den Produkte. Die Kennzeichnung KEY MARK und die Kennzeichnung UNI-Certiquality bescheinigt, dass die zertifizierten Produkte den Europäischen Richtlinien EN 14411 für Keramikfliesen entsprechen. Die zertifizierten Produkte sind in der eigenen Tabelle dieser Abschnitt angegeben.

UNI EN ISO 14001:2015



CERTIFIED ENVIRONMENTAL MANAGEMENT SYSTEM

UNI EN ISO 14001

CERTIFICAZIONE DEL SISTEMA AMBIENTALE DEI SITI PRODUTTIVI

ENVIRONMENTAL CERTIFICATION FOR PRODUCTION SITES | CERTIFICATION DU SYSTÈME ENVIRONNEMENTAL DES SITES PRODUCTIFS | ZERTIFIZIERUNG DES UMWELTSSYSTEMS DER PRODUKTIONSSTÄTTE

ISO 9001:2015



CERTIFIED QUALITY MANAGEMENT SYSTEM

UNI EN ISO 9001

CERTIFICAZIONE DEL SISTEMA DI GESTIONE DELLA QUALITÀ DEI SITI PRODUTTIVI

QUALITY MANAGEMENT SYSTEM CERTIFICATION FOR PRODUCTION SITES | CERTIFICATION DU SYSTÈME DE GESTION DE LA QUALITÉ DES SITES DE PRODUCTION | ZERTIFIZIERUNG DES QUALITÄTSMANAGEMENTSSYSTEMS DER PRODUKTIONSSTÄTTEN

EPD

EPD - DICHIARAZIONE AMBIENTALE DI PRODOTTO

EPD - ENVIRONMENTAL PRODUCT DECLARATION | DEP - DÉCLARATION ENVIRONNEMENTALE PRODUIT
EPD - UMWELT-PRODUKTDEKLARATION

La Dichiarazione Ambientale di Prodotto (EPD) comunica in modo trasparente le prestazioni ambientali del gres porcellanato Cotto d'Este basandosi sull'analisi del ciclo di vita (LCA). I prodotti Cotto d'Este possiedono EPD specifica di tipo III, certificata da ente terzo indipendente secondo le normative EN 14025 e EN 15804 (PCR di riferimento).

I Prodotti certificati EPD sono richiesti dai principali sistemi di certificazione degli edifici quali LEED (internazionale), BREEAM (Inghilterra), HQE (Francia) e DGNB (Germania), nonché in schemi legislativi in Italia (requisiti per appalti pubblici sostenibili). È una certificazione volontaria, che valorizza ancor più i materiali Cotto d'Este perché prodotti secondo i migliori standard di sostenibilità e responsabilità.

The Environmental Product Declaration (EPD) is a transparency tool that communicates the environmental performances of Cotto d'Este porcelain tile through a Life Cycle Assessment (LCA).

Cotto d'Este products have a type III specific EPD. This is certified by an independent third party according to EN 14025 and EN 15804 standards (applicable PCR). EPD certified products are required by the main construction certifying bodies such as LEED (international), BREEAM (England), HQE (France), and DGNB (Germany), as well as the legislative frameworks in Italy (requisites for sustainable public contracts). It is a voluntary certification that gives additional value to Cotto d'Este products because they are manufactured according to the highest standards of sustainability and responsibility.

La Déclaration Environnementale Produit (DEP) communique de manière transparente les performances environnementales du gres cérame Cotto d'Este en se basant sur l'analyse du cycle de vie (ACV). Les produits Cotto d'Este possèdent la déclaration environnementale (DEP) de type III, certifiée par un tiers indépendant conformément aux normes EN 14025 et EN 15804 (PCR de référence). Les produits certifiés DEP sont requis par les principaux organismes de certification pour la construction comme LEED (international), BREEAM (Angleterre), HQE (France) et DGNB (Allemagne), et par les cadres législatifs prévus en Italie (conditions pour participer aux marchés publics durables). Cette certification est une démarche volontaire, et vise à apporter une valeur supplémentaire aux matériaux Cotto d'Este, fabriqués de manière responsable et selon les meilleurs standards écologiques.

Die Umwelt-Produktdeklaration (EPD) teilt in einer transparenten Art und Weise die Umweltleistung von Feinsteinzeug Cotto d'Este auf der Grundlage der "Lebenszyklusanalyse" (LCA) mit. Die Produkte Cotto d'Este verfügen über eine EPD vom Typ III, die von einem unabhängigen Dritten nach den Normen EN 14025 und EN 15804 (Referenz-PCR) zertifiziert wurde. EPD-zertifizierte Produkte werden von den wichtigsten Gebäudezertifizierungssystemen gefordert, wie z.B. LEED (International), BREEAM (England), HQE (Frankreich) und DGNB (Deutschland), sowie in Gesetzgebungsregelungen in Italien (Anforderungen für nachhaltige öffentliche Beschaffung) verlangt wird. Es ist eine freiwillige Zertifizierung, die die Materialien Cotto d'Este Produkte weiter aufwertet, da sie nach den höchsten Standards der Nachhaltigkeit und Verantwortung produziert werden.

CERTIFICAZIONI CERTIFICATIONS | CERTIFICATIONS | ZERTIFIKATE



CLASSIFICAZIONE QB-UPEC

QB-UPEC CLASSIFICATION | CLASSIFICATION QB-UPEC | BEWERTUNG NACH QB-UPEC

È una certificazione di prodotto rilasciata dall'istituto francese CSTB, che verifica l'idoneità tecnica dei prodotti di prima scelta in relazione al tipo di destinazione. I prodotti con classamento NF-UPEC sono indicati all'interno del catalogo.

This is a product certification issued by the French CSTB institute, which verifies the technical suitability of first grade products for their intended use. Products with NF-UPEC classification are indicated in the catalogue.

Il s'agit d'une certification de produit délivrée par l'institut français CSTB qui atteste la conformité technique des produits de première qualité en fonction du type d'utilisation auquel ils sont destinés. Les produits à classement NF-UPEC sont indiqués dans le catalogue.

Es handelt sich um eine vom französischen Institut CSTB erteilten Produktzertifizierung, welche die technische Eignung der Produkte erster Wahl je nach Art ihres Bestimmungszwecks prüft. Im Katalog ist angegeben, welche Produkte die NF-UPEC-Zertifizierung besitzen.



Ceramics of Italy

IL MARCHIO DELL'INDUSTRIA CERAMICA ITALIANA

THE TRADEMARK OF THE ITALIAN CERAMIC INDUSTRY | LA MARQUE DE L'INDUSTRIE CÉRAMIQUE ITALIENNE | DIE MARKE DER ITALIENISCHEN KERAMIKINDUSTRIE

Ceramics of Italy è il marchio istituzionale e settoriale che rappresenta e promuove le aziende dell'industria ceramica italiana nel mondo.

Cotto d'Este tramite Panariagroup SpA può contrassegnare i propri prodotti con il marchio Ceramics of Italy che li attesta come caratterizzati da un elevato design in grado di qualificare gli spazi dell'abitare, frutto di moderne tecnologie che producono nel massimo rispetto dell'ambiente, con una grande attenzione alla sicurezza sul posto di lavoro, alla costante ricerca dell'ottimizzazione delle risorse impiegate, secondo i più elevati standard prestazionali. Ceramics of Italy rappresenta la volontà dell'industria italiana delle piastrelle di ceramica nel diffondere e promuovere in Italia e all'estero una nuova valenza della piastrella di ceramica: non più prodotto per l'industria delle costruzioni, ma punto di riferimento per stile e creatività per lo sviluppo di una nuova cultura dell'abitare Made in Italy.

Ceramics of Italy, promosso da Confindustria Ceramica, è un marchio registrato di Edi.Cer. Spa, l'organizzatore di Cersaie - Salone internazionale della ceramica

Ceramics of Italy is the institutional trademark that represents and promotes Italian ceramic industries on a worldwide level.

Through Panariagroup SpA, Cotto d'Este can label its products with the Ceramics of Italy trademark, which confirms their high standard of design, the use of the latest technology, concern for the environment and for safety at work and constant research for optimising the resources employed, in compliance with the highest performance standards. Ceramics of Italy embodies the will of the Italian ceramic tile industry to promote the awareness and esteem of Italian ceramic tiles amongst international users: ceramic tiles are not mere building materials but a reference point for style and creativity and for the development of a new way of living. Made in Italy.

Ceramics of Italy, promoted by Confindustria Ceramica, is a registered trademark of Edi.Cer. Spa, the organiser of Cersaie - the International ceramics exhibition.

Ceramics of Italy est la marque institutionnelle et sectorielle qui représente et promeut les sociétés de l'industrie céramique italienne dans le monde.

Cotto d'Este, par le biais de Panariagroup SpA, peut apposer la marque Ceramics of Italy sur ses propres produits. Cette marque certifie que les produits sont caractérisés par un design sophistiqué en mesure de qualifier les espaces habitatifs, fruit de technologies modernes qui produisent dans le plein respect de l'environnement, en réservant une grande attention à la sécurité sur le lieu de travail, à la recherche constante de l'optimisation des ressources utilisées, selon les plus hauts niveaux de performance. Ceramics of Italy représente la volonté de l'industrie italienne des carreaux de céramique à divulguer et à promouvoir en Italie et à l'étranger un nouveau concept du carreau céramique : non plus produit pour l'industrie du bâtiment, mais plutôt point de référence, niveau style et créativité, pour le développement d'une nouvelle culture de l'habitation Made in Italy.

Ceramics of Italy, promue par Confindustria Ceramica, est une marque enregistrée d'Edi.Cer. Spa, l'organisateur de Cersaie - Salon international de la céramique.

Ceramics of Italy ist die institutionelle Branchenmarke, die die Unternehmen der italienischen Keramikindustrie in der Welt vertritt und fördert.

Cotto d'Este darf durch die Panariagroup SpA ihre Produkte mit der Marke Ceramics of Italy kennzeichnen; diese gilt als Bescheinigung für Produkte mit einem gehobenen Design für die Qualifizierung der Wohnbereiche aus der Fertigung mit modernen Technologien, die mit einem maximalen Umweltschutz, einer großen Aufmerksamkeit für die Sicherheit am Arbeitsplatz und einer konstanten Forschung die Optimierung der eingesetzten Ressourcen nach höchsten Leistungsstandards anstreben. Ceramics of Italy vertritt die Absicht der italienischen Keramikindustrie, eine neue Valenz der Keramikfliesen in Italien und im Ausland zu verbreiten und zu fördern: Nicht mehr nur ein Produkt für die Bauindustrie, sondern Anhaltspunkt für Stil und Kreativität zur Entwicklung einer neuen Wohnkultur Made in Italy.

Ceramics of Italy wird von der Confindustria Ceramica gefördert und ist ein registriertes Markenzeichen von Edi.Cer. Spa, die Organisation der Internationalen Keramikmesse Cersaie.

CE	EN 14411
DOP001EST DOP004EST DOP005EST	Cotto d'Este Porcelain Tiles: Dry-pressed ceramic tiles with low water absorption E ≤ 0,5% for flooring and wall finishes, internal and external applications (DOP001EST).
05	Kerlite 3 Plus: Dry pressed ceramic tiles with low water absorption E ≤ 0,5% for internal flooring and internal and external wall applications (DOP004EST).
COTTO D'ESTE Nuove Superfici via Emilia Romagna, 31 - 41049 Sassuolo (MO) - Italy Panariagroup Industrie Ceramiche S.p.A.	Kerlite 5 Plus/6 Plus: Dry pressed ceramic tiles with low water absorption E ≤ 0,5% for internal flooring and internal and external wall applications (DOP005EST).

MARCHIO EUROPEO CE DI SICUREZZA.

CE SECURITY MARK | MARQUAGE DE SÉCURITÉ CE | EUROPÄISCHE CE SICHERHEITSMARKE

La marcatura CE è la certificazione di sicurezza del prodotto richiesta dall'Unione Europea, ed ha lo scopo di salvaguardare la salute delle persone e i beni nelle opere di costruzione.

Il nuovo Regolamento UE N. 305/2011 entra in vigore il 1 luglio 2013. La novità più rilevante è l'introduzione della Dichiarazione di Prestazione (DOP, Declaration Of Performance) con la quale il fabbricante comunica i requisiti di sicurezza dei propri materiali.

Le lastre in gres porcellanato Kerlite sono in possesso del marchio CE (cfr. DOP004EST-DOP005EST). L'applicazione sul retro di una rete in fibra di vetro conferisce a questi prodotti le classi di reazione al fuoco indicate nelle tabelle tecniche Kerlite.

Le DOP di Cotto d'Este sono disponibili sul sito internet www.cottodeste.it.

The CE mark is the safety product certification required by EU and it is finalized to preserve the people's health and the goods in buildings.

The new Regulation UE N. 305/2011 is valid from the first of July 2013. The most important news is the introduction of the Declaration Of Performance (DOP) with which the supplier communicates the safety requirements concerning own materials.

Kerlite porcelain stoneware slabs have the CE mark (cf. DOP004EST-DOP005EST). The application of a fibreglass mesh on the back confer to these products the categories of fire resistance indicated in the Kerlite technical tables.

Cotto d'Este DOP are available on the website www.cottodeste.it.

La marque CE est la certification de sécurité des produits demandé par l'Union Européenne ayant comme objectif la protection et la santé des personnes et des biens dans les ouvrages du bâtiments.

Le nouveau Règlement UE Nr. 305/2011 entre en vigueur le 1er Juillet 2013. La nouveauté la plus importante est l'introduction de la Déclaration de Prestation (DOP, Declaration Of Performance) par la quelle le fabricant communique les caractéristiques de sécurité de ses produits.

Les dalles en grès cérame Kerlite possèdent le marquage CE (cfr. DOP004EST-DOP005EST). L'application d'une couche en fibre de verre au dos de chaque dalle confère aux produits une haute résistance au feu. La classe de résistance des dalles est disponible dans les tableaux techniques Kerlite.

Les DOP de Cotto d'Este sont disponibles sur le site internet www.cottodeste.it.

Das CE- Kennzeichnung ist die von EU angefragte Zertifizierung für die Produkt- Sicherheit, und hat das Zweck die Gesundheit der Menschen zu schützen und die Güter in der Bauphase zu bewahren.



Die neue Regelung UE N. 305/2011 tritt am 1.07.2013 in Kraft. Die wichtigste Neuheit ist die Einfügung der Leistungserklärung (DOP, Declaration Of Performance), mit der der Hersteller die Sicherheitsanforderungen eigenen Materialien mitteilt.

Die Feinsteinzeugfliesen Kerlite sind mit dem CE-Markenzeichen versehen (siehe DOP004EST-DOP005EST). Die Anwendung eines Glasfasernetzes auf der Rückseite der Fliesen verleiht diesen Produkten die in den technischen Tabellen Kerlite aufgeführten Brandklassen.

Die DOP Cotto d'Este sind auf Internet Site www.cottodeste.it verfügbar.

CERTIFICAZIONI
 CERTIFICATIONS | CERTIFICATIONS | ZERTIFIKATE



 Gres porcellanato spessorato Extra thick porcelain stoneware Grès cérame à épaisseur majorée Extra-Dickes Feinsteinzeug			Spessore 14 mm Thickness Épaisseur Dicke		
BUXY	Nat Rett.	•			
	Lux Rett.	•			
CADORE	Rett.				
CASALI					
CEMENT PROJECT	Land Naturale Rett. - Land Lappata Rett.				
CLUNY	Sablé Rett. - Adouci Rett.	•			
	Layé Rett.				
EXEDRA	Silk Rett.	•			
	Glossy Rett.	•			
LIMESTONE	Natural Rett. - Blazed Rett. - Honed Rett.	•			
SECRET STONE	Natural Rett. - Honed Rett. - Grip Rett.	•			
STONEQUARTZ	Fiammata Rett.	•			
X-BETON	Naturale Rett. - Satinata Rett.	•			
 Gres porcellanato superspessorato Ultra thick porcelain stoneware Grès cérame à épaisseur fortement majorée Super-Dickes Feinsteinzeug			Spessore 20 mm Thickness Épaisseur Dicke		
PIETRA D'ISEO	Naturale Rett.	•			
STONEQUARTZ	Fiammata Rett.				
X-BETON	Rett.				
 Gres porcellanato laminato Laminated porcelain stoneware Grès cérame laminé Laminiertes Feinsteinzeug			Spessore 5,5 mm Thickness Épaisseur Dicke		
EXEDRA	Silk	•			
LIMESTONE	Naturale	•			
MATERICA		•			



PT0128	PT0061	
		•
		•
	30x180 - 20x180	•
		•
	60x60 Sablé	•
		•
		•
	60x120 - 90x90 - 60x60 - 30x60 Natural	•
	60x120 - 90x90 - 60x60 - 30x60 Natural	•
60x120 - 60x60		•
	60x120 - 90x90 - 60x60 Naturale	•
		•
		•

PACKAGING | EMBALLAGES | VERPACKUNGEN

FORMATI (CM) SIZES (CM) FORMATS (CM) FORMATEN (CM)	Pezzi per scatola Pieces per box Pièces par boîte Stücke pro Karton	Mq per scatola Sq.mt. per box M ² par boîte Qm. pro Karton	Kg per scatola Kg per box Kg par boîte Kg pro Karton	Scatole per pallet Boxes per pallet Cartons par palette Karton pro Palette	Mq per pallet Sq.mt. per pallet M ² par palette Qm. pro Palette	Kg per pallet Kg per pallet Kg par palette Kg pro Palette
14 MM						
30x180	2	1,08	34,00	45	48,60	1530
20x180	3	1,08	32,65	40	43,20	1305
60x120	1	0,72	23,00	21	15,12	483
58x116	1	0,672	21,24	21	23,04	446
20x120	4	0,96	29,00	24	23,04	696
15x120	5	0,90	26,00	40	36	1040
90x90	1	0,81	25,20	21	17,01	529
88x88	1	0,77	24,89	21	16,26	522
60x60	3	1,08	32,50	32	34,56	1040
30x60	6	1,08	32,50	32	34,56	1040
30x30	7	0,63	20,40	60	37,80	1224
15x30	14	0,63	20,80	56	35,28	1164

KERLITE 3PLUS

100x300	-	3 al pz	-	20 pz sfusi	60	468
100x100	3	3	23,4	25	75	585
50x100	5	2,5	20	32	80	640
50x50	7	1,75	13,65	48	84	655

KERLITE 5PLUS

100x300	-	3 al pz	-	13 pz sfusi	39,00	481
100x250	-	2,50 al pz	-	13 pz sfusi	32,50	373,8
33x300	-	0,99 al pz	-	39 pz sfusi	38,61	444,015
20x180	3	1,08	12,42	40	43,20	496
50x150	2	1,50	17,25	32	48,00	552
20x120	3	0,72	8,28	60	43,20	496
100x100	2	2,00	23,00	25	50,00	575
50x100	3	1,50	17,25	32	48,00	552

KERLITE 6PLUS

120x260	-	3,12 al pz	14,30	18 pz sfusi	56,16	804,60
30x240	-	0,72	11,20	40	75	840
120x120	2	2,88	41,20	23	66,24	947,60
60x120	3	2,16	30,90	15	32,40	463,50
20x120	3	0,72	11,20	75	54	840
60x60	4	1,44	20,60	24	34,56	494,20

20 MM

60x120	1	0,72	32,5	16	11,52	520
30x120	2	0,72	33,25	16	11,52	532
90x90	1	0,81	37,30	30	24,30	1119
75x75	1	0,562	24,90	42	23,60	1045
60x60	2	0,72	32,50	32	23,04	1040

PEZZI SPECIALI | SPECIAL PIECES | PIECES SPECIALES | SPEZIALSTÜCKE

FORMATI (CM) SIZES (CM) FORMATS (CM) FORMATEN (CM)	SPESSORE (CM) THICKNESS (CM) ÉPAISSEUR (CM) STÄRKE (CM)	Pezzi per scatola Pieces per box Pièces par boîte Stücke pro Karton	ml per scatola lm per box ml par boîte lm pro Karton	Kg per scatola Kg per box Kg par boîte Kg pro Karton	Scatole per pallet Boxes per pallet Cartons par palette Karton pro Palette	ml per pallet lm per pallet ml par palette lm pro Palette	Kg per pallet Kg per pallet Kg par palette Kg pro Palette
---	--	--	---	---	---	--	--

BATTISCOPIA SKIRTING TILE PLINTHE SOCKELLEISTE							
90x7,2	1,4	13	11,70	26,00	30	351	780
88x7,2	1,4	13	11,44	25,40	30	343,20	762
60x10	1	16	9,66	21,48	48	463,87	1031
60x7,2	1,4	9	5,40	14,58	40	216,00	583
30x7,2	1,4	22	6,6	15	62	409,20	930

FORMATI (CM) SIZES (CM) FORMATS (CM) FORMATEN (CM)	SPESSORE (CM) THICKNESS (CM) ÉPAISSEUR (CM) STÄRKE (CM)	Pezzi per scatola Pieces per box Pièces par boîte Stücke pro Karton	Kg per scatola Kg per box Kg par boîte Kg pro Karton	Scatole per pallet Boxes per pallet Cartons par palette Karton pro Palette	Pezzi per pallet Pieces per pallet Pièces par palette Stücke pro Palette	Kg per pallet Kg per pallet Kg par palette Kg pro Palette
---	--	--	---	---	---	--

GRADINI THIN STEP TREAD PLAT DE MARCHE STUFENPLATTE						
120x34 Plus	4,5/1,4	1	20,50	24	24	492
120x34 Plus Ang.	4,5/1,4	1	15,5	24	24	372
120x34	1,4	2	44	80	160	3600
60x34 Plus	4,5/1,4	2	15,4	48	96	739,2
60x34 Plus Ang.	4,5/1,4	2	16,4	48	96	787,2
60x34	1,4	5	32,5	32	160	1040
45x34 Plus	4,5/1,4	2	12	30	60	360
33x33 Ang.	1	2	5,60	68	136	380
33x30	1	6	15,60	34	204	530,4





20 MM PEZZI SPECIALI | SPECIAL PIECES | PIECES SPECIALES | SPEZIALSTÜCKE

FORMATI (CM) SIZES (CM) FORMATS (CM) FORMATEN (CM)	Pezzi per scatola Pieces per box Pièces par boîte Stücke pro Karton	Mq per scatola Sq.mt. per box M ² par boîte Qm. pro Karton	Kg per scatola Kg per box Kg par boîte Kg pro Karton	Scatole per pallet Boxes per pallet Cartons par palette Karton pro Palette	Pezzi per pallet Pieces per pallet Pièces par palette Stücke pro Palette	Kg per pallet Kg per pallet Kg par palette Kg pro Palette
---	--	--	---	---	---	--

ELEMENTO GRIGLIA GRILL COMPONENT PIÈCE GRILLE GITTER SONDERTEIL						
75x15/60x15	2/2	-	10/8	64/100	128/200	640/800
GRADONE COSTA RETTA RIGATO CON GOCCIOLATOIO STEP TREAD WITH GROOVES AND DRIP FLAP PLAT DE MARCHE AVEC RAINURES ET GOUTTE D'EAU STUFENPLATTE MIT RILLEN UND WASSERNASE						
75x34/60x30	1/1	-	11,50/8,125	128/100	128/100	1472/812

DESTINAZIONI D'USO

INTENDED USES | UTILISATIONS PRÉVUES | EINSATZBEREICHE

LEGENDA LEGEND LÉGENDE LEGENDE	 Residenziale Residential Résidentiel Wohngebiet	 Commerciale leggero Light commercial Commercial léger Leichte gewerbliche Anwendungen	 Commerciale intensivo Intensive commercial Commercial intensif Intensive gewerbliche Anwendungen	 Esterni Outdoor Extérieurs Außenbereiche
14mm				
BUXY	naturale/lux	naturale/lux	naturale/lux	flammé
CADORE	naturale	naturale	naturale	
CASALI	naturale	naturale	naturale	
CEMENT PROJECT	land naturale/land lappata	land naturale/land lappata	land naturale/land lappata	
CLUNY	adouci/sablé	adouci/sablé	adouci/sablé	layé
EXEDRA	silk/glossy	silk/glossy		
LIMESTONE	natural/honed/blazed			
SECRET STONE	natural/honed	natural/honed	natural	
STONE QUARTZ	fiammata	fiammata	fiammata	fiammata
X-BETON	naturale/satinata	naturale/satinata	naturale/satinata	
20mm				
BLUESTONE				layé
CADORE				naturale
CEMENT PROJECT				work
CLUNY				layé
LIMESTONE				natural/fiammata
PIETRA D'ISEO				bocciardata
SECRET STONE				grip
STONE QUARTZ				fiammata
X-BETON				fiammata

Residenziale: Cucine, bagni, living e ogni altro ambiente di uso residenziale.

Commerciale leggero: Uffici, uffici aperti al pubblico, sale d'attesa, negozi, bagni pubblici, aree comuni condominiali, sale di ristoranti, autosaloni, bar, cinema, ambulatori/cliniche, camere e bagni di hotel. In aree caratterizzate da passaggi obbligati non è consigliato l'utilizzo di prodotti con finitura GLOSSY/TOUCH.

Commerciale intensivo: Aree comuni di centri commerciali, hall di hotel, mense, fast food, discoteche, ospedali, scuole, musei, luoghi di culto, aeroporti, stazioni.

Esterni: Prevalentemente per ambienti esterni nei quali è richiesta una pavimentazione con prestazioni anticivolo.

NOTE

La finitura GLOSSY/TOUCH è consigliata, oltre che per rivestimenti, anche per pavimenti in ambienti residenziali o commerciale leggero non sottoposti ad elevate sollecitazioni, ove non siano richieste prestazioni anticivolo. La presenza sporadica di piccole disuniformità o di puntini sulla superficie è da ritenersi come caratteristica del materiale e della particolare lavorazione. Qualora il prodotto sia posto a diretto contatto con l'esterno, si consiglia di utilizzare soluzioni protettive al fine di prevenire la formazione di graffi. In aree caratterizzate dal passaggio di carichi pesanti concentrati non è consigliato l'utilizzo di prodotti a spessore ridotto.

Residential: Kitchens, bathrooms, living rooms and other residential environments

Light commercial: Offices, offices open to the general public, waiting rooms, shops, public bathrooms, common apartment block areas, restaurant dining rooms, car showrooms, bars, cinemas, surgeries/clinics, hotel rooms and bathrooms. In areas subjected to forced traffic, it is not advisable to use products with the GLOSSY/TOUCH finishes.

Intensive commercial: Common areas of shopping centres, hotel foyers, canteens, fast food restaurants, dance clubs, hospitals, schools, museums, places of worship, airports, stations.



Outdoor: Mainly for external areas that require flooring with anti-slip characteristics.

NOTE

The GLOSSY/TOUCH finishes are recommended, as well as for wall cladding, also for flooring in residential or light commercial areas that are not subjected to heavy traffic, where anti-slip characteristics are not required. The occasional presence of small inconsistencies or little spots on the surface is to be considered a characteristic of the material and of its unique production process. If the product is laid in direct contact with external environments, it is recommended to use protective solutions to reduce the formation of scratches. In areas that are subjected to heavy concentrated loads it is not recommended to use low thickness products.

LEGENDA

LEGEND
LÉGENDE
LEGENDE

 Residenziale Residential Résidentiel Wohngebiet	 Commerciale leggero Light commercial Commercial léger Leichte gewerbliche Anwendungen	 Commerciale intensivo Intensive commercial Commercial intensif Intensive gewerbliche Anwendungen	 Esterni Outdoor Extérieurs Außenbereiche
3Plus (3.5mm)			
BLACK&WHITE	naturale	naturale	
BUXY	naturale/lux	naturale/lux	
CLUNY	naturale	naturale	
OVER	naturale/soft	naturale	
WONDERWALL	matrix	matrix	
5Plus (5.5mm)			
BLACK&WHITE	glossy/silk	glossy/silk	
CEMENT PROJECT	cem/work	cem/work	cem/work
CLUNY	layé	layé	layé
ELEGANCE	silk	silk	
EXEDRA	silk/glossy	silk/glossy	
FOREST	naturale	naturale	naturale
LIMESTONE	natural	natural	natural
MATERICA	naturale	naturale	naturale
METAL	naturale	naturale	naturale
6Plus (6.5mm)			
PIETRA D'ISEO	naturale	naturale	naturale
VANITY	glossy/touch	glossy/touch	
WOODLAND	naturale	naturale	naturale

Résidentiel: Cuisines, salles de bains, salons et tout autre espace à usage résidentiel.

Commercial léger: Bureaux, bureaux ouverts au public, salles d'attente, magasins, toilettes publiques, espaces communs de logements collectifs, salles de restaurants, salons automobiles, bars, cinémas, cabinets médicaux/cliniques, chambres et salles de bains d'hôtels. Dans les zones caractérisées par des passages obligatoires, l'utilisation de produits avec une finition LUX/LEV/GLOSSY/TOUCH n'est pas recommandée.

Commercial intensif: Zones communes de centres commerciaux, halls d'hôtels, cantines, fast-foods, discothèques, hôpitaux, écoles, musées, lieux de culte, aéroports, gares.

Extérieurs: Principalement pour les environnements extérieurs où un sol antidérapant est requis.

REMARQUES

En plus des revêtements, la finition LUX/LEV/GLOSSY/TOUCH est également recommandée pour les sols dans les environnements résidentiels ou commerciaux légers peu soumis à des contraintes élevées, pour lesquels aucune prestation antidérapante n'est requise. La présence sporadique de petites irrégularités ou de points à la surface doit être considérée comme une caractéristique du matériau et de sa fabrication particulière. Si le produit est placé en contact direct avec l'extérieur, il est conseillé d'utiliser des solutions de protection afin d'éviter la formation de rayures. Dans les zones à passage de charges lourdes concentrées, l'utilisation de produits d'épaisseur réduite n'est pas recommandée.

Wohngebiet: Küchen, Badezimmer, Wohnzimmer und alle sonstigen Wohnbereiche.

Leichte gewerbliche Anwendungen: Büroräume, öffentliche Büros, Wartezimmer, Geschäfte, öffentliche Toiletten, Gemeinschaftsflächen in Mehrfamilienhäusern, Gaststätten, Autohäuser, Cafés, Kinos, Praxen/Kliniken, Hotelzimmer und -badezimmer. In Bereichen mit obligatorischen Durchgängen ist der Einsatz von Produkten mit den Oberflächen LUX/LEV/GLOSSY/TOUCH nicht empfohlen.

Intensive gewerbliche Anwendungen: Gemeinschaftsbereiche in Einkaufszentren, Hotelhallen, Kantinen, Fastfood-Restaurants, Diskotheken, Krankenhäuser, Schulen, Museen, Kultstätten, Flughäfen, Bahnhöfe.

Außenbereiche: Vor allem für Außenbereiche, in denen ein rutschfester Boden erforderlich ist.

ANMERKUNGEN

Die Oberfläche LUX/LEV/GLOSSY/TOUCH wird nicht nur für Wandverkleidungen empfohlen, sondern auch für Böden in Wohn- bzw. Gewerbebereichen, die keiner hohen Belastung ausgesetzt sind und bei denen keine rutschhemmende Wirkung erforderlich ist. Das sporadische Vorhandensein von kleinen Unebenheiten oder Punkten auf der Oberfläche ist als ein Merkmal von Material und besonderer Verarbeitung zu betrachten. Wird das Produkt in direkten Kontakt mit der Außenseite gebracht, wird empfohlen, Schutzlösungen zu verwenden, um die Bildung von Kratzern zu vermeiden. In Bereichen, die schwerer Belastung ausgesetzt sind, ist die Verwendung von Produkten mit reduzierter Stärke nicht empfehlenswert.

CONDIZIONI GENERALI DI VENDITA

1) Ambito di applicazione

1.1 Le presenti condizioni generali di vendita ("CGV") si applicheranno a tutte le forniture di piastrelle in ceramica o altri prodotti in ceramica ("Prodotti") che saranno eseguite nei confronti di qualsiasi cliente ("CLIENTE") da una società o divisione del Gruppo Panariagroup Industrie Ceramiche S.p.A. ("VENDITORE") anche se le CGV non verranno di volta in volta espressamente richiamate, menzionate ovvero espressamente accettate dal CLIENTE.

1.2 Accordi in deroga alle presenti CGV saranno efficaci nei confronti di VENDITORE soltanto (i) se contenuti nel "Contratto di Vendita", come definito al successivo paragrafo 3.2, (ii) se contenuti in documenti successivi alla conclusione del Contratto di Vendita ed il cui contenuto sia stato accettato per iscritto da VENDITORE. In ogni caso, anche se presenti deroghe concordate per iscritto, le CGV continueranno ad applicarsi per le parti non espressamente derogate.

1.3 In nessun caso VENDITORE sarà vincolato da eventuali condizioni generali di contratto di CLIENTE, neanche qualora esse siano richiamate o riportate negli ordini o in qualsiasi altra documentazione trasmessa a VENDITORE da CLIENTE. Nessun comportamento di VENDITORE potrà essere interpretato o utilizzato al fine di esprimere tacita accettazione di VENDITORE delle condizioni generali di contratto di CLIENTE.

1.4 In nessun caso, VENDITORE sarà vincolato da atti e/o azioni dei propri agenti, essendo questi ultimi privi del potere di vincolare il VENDITORE.

1.5 Nel caso in cui CLIENTE sia un consumatore, le disposizioni delle presenti CGV non pregiudicheranno i diritti allo stesso spettanti in base alle previsioni di legge relative alle vendite eseguite nei confronti dei consumatori.

2) Prodotti – Modifiche

2.1 Le rappresentazioni e/o immagini riguardanti i Prodotti riportate in siti internet, brochure, cataloghi, listini prezzi o documenti similari di VENDITORE hanno valore indicativo ed illustrativo. Conseguentemente, esse non rappresentano il risultato estetico finale dei Prodotti. Le caratteristiche tecniche e fisiche nonché le qualità dei Prodotti sono riportate unicamente nei manuali tecnici di VENDITORE. Ogni altro documento riportante le caratteristiche tecniche e fisiche nonché le qualità dei Prodotti ha valore puramente indicativo e non sarà vincolante per VENDITORE.

2.2 VENDITORE dichiara che i Prodotti sono conformi alle norme italiane e comunitarie di settore ad essi applicabili. A pena di inefficacia della garanzia di cui all'articolo 7 e di qualsiasi altra garanzia convenzionale e/o legale, ciascun Prodotto dovrà essere utilizzato ed applicato in conformità alle indicazioni di utilizzo di VENDITORE riferite ai Prodotti in questione e riportate nei cataloghi e/o nei manuali tecnici di VENDITORE ovvero diversamente comunicate o rese accessibili da VENDITORE a CLIENTE e, comunque, in conformità alla diligenza richiesta dalla natura dei Prodotti stessi.

2.3 È responsabilità di CLIENTE, prima della conclusione del Contratto di Vendita, accertare che i Prodotti siano idonei allo scopo e/o all'uso specifico per il quale intende acquistarli e, inoltre, accertare che i Prodotti medesimi siano conformi alla normativa applicabile nel luogo in cui CLIENTE intende impartarli, distribuirli, venderli o farne qualsiasi uso.

2.4 VENDITORE, anche dopo la conclusione del Contratto di Vendita, potrà apportare ai Prodotti qualsiasi modifica che esso ritenga necessaria o opportuna, purché non ne alteri le caratteristiche essenziali. Qualora VENDITORE esegua modifiche sostanziali ai Prodotti (ad es. modifiche che interessano: le modalità di installazione, le caratteristiche di intercambiabilità dei Prodotti ecc.) oggetto di un Contratto di Vendita (come definito al successivo paragrafo 3.2), VENDITORE comunicherà per iscritto tale modifica a CLIENTE.

2.5 CLIENTE sarà tenuto a rappresentare agli acquirenti dei Prodotti e ai terzi le caratteristiche dei Prodotti nonché le indicazioni d'uso e di applicazione degli stessi, in conformità a quanto rappresentatogli da VENDITORE. Fermo restando quanto sopra, CLIENTE sarà esclusivamente responsabile per le dichiarazioni effettuate nei confronti dei terzi in relazione ai Prodotti, alle loro caratteristiche e al loro uso e/o applicazione e dovrà tenere VENDITORE indenne e manlevato da qualsiasi danno eventualmente subito da VENDITORE in relazione a o in connessione con tali dichiarazioni di CLIENTE, nel caso in cui le stesse siano false, incomplete e/o inesatte.

3) Preventivi – Conclusione del Contratto di Vendita - Tolleranze

3.1 I preventivi, verbali o scritti, di VENDITORE non costituiscono proposte contrattuali.

3.2 Il contratto di vendita ("Contratto di Vendita") si perfezionerà attraverso:

a) la trasmissione della offerta da parte di VENDITORE e l'accettazione scritta di tale offerta da parte di CLIENTE senza alcuna modifica all'offerta stessa; oppure
b) la trasmissione dell'ordine da parte di CLIENTE e l'accettazione scritta di tale ordine da parte di VENDITORE.

3.3 Ai fini del precedente paragrafo 3.2, lettera a) i seguenti fatti o atti avranno valore di accettazione scritta della offerta di VENDITORE da parte di CLIENTE:

a) ricezione e accettazione, da parte di VENDITORE, di una lettera di credito procurata da CLIENTE;
b) ricezione e accettazione, da parte di VENDITORE, di tutto o di parte del prezzo della fornitura;
c) ricezione, da parte di VENDITORE, di un ordine di acquisto emesso da CLIENTE. In tal caso, qualsiasi previsione dell'ordine di acquisto di CLIENTE che risulti difforme dalle previsioni della offerta di VENDITORE sarà vincolante nei confronti di VENDITORE solo se specificamente accettata per iscritto da quest'ultimo.

3.4 Inoltre, ai fini del precedente paragrafo 3.2, lettera b), nel caso in cui la accettazione di VENDITORE dell'ordine di CLIENTE contenga condizioni differenti rispetto all'ordine formulato da CLIENTE, il Contratto di Vendita si considererà concluso alle condizioni riportate nella conferma d'ordine di VENDITORE, salvo il caso in cui CLIENTE comunichi per iscritto di rifiutare le modifiche riportate nella accettazione dell'ordine di VENDITORE entro 1 (uno) giorno lavorativo dalla ricezione della stessa.

3.5 Le forniture comprenderanno esclusivamente quanto indicato nel Contratto di Vendita.

3.6 CLIENTE riconosce a VENDITORE i margini di tolleranza quantitativa e/o qualitativa rinvenibili dal Contratto di Vendita o dagli usi o dalla prassi del settore dei Prodotti.

4) Imballaggio – Termini di resa – Termini di consegna

4.1 I Prodotti saranno imballati ed approntati per la spedizione secondo i sistemi di protezione generalmente adottati da VENDITORE per i Prodotti in questione in considerazione delle modalità di trasporto convenute. Qualora CLIENTE ritenga necessario l'impiego di imballaggi speciali o di protezioni aggiuntive dovrà farne espressa richiesta a VENDITORE, fermo restando che, in tal caso, saranno a carico di CLIENTE tutti i relativi costi.

4.2 Salvo diversamente previsto nel Contratto di Vendita, i Prodotti saranno consegnati a CLIENTE in conformità alla regola Incoterms® ICC, ultima versione, Ex-Works (EXW) – stabilimento di VENDITORE indicato nel Contratto di Vendita.

CLIENTE autorizza VENDITORE a sottoscrivere, in nome e per conto di CLIENTE, tutti i documenti che debbano essere sottoscritti al momento della presa in carico dei Prodotti presso gli stabilimenti di VENDITORE, come, ad esempio, il CMR.

Nel caso in cui la regola Incoterms® ICC concordata tra le parti preveda che CLIENTE debba curare il trasporto dei Prodotti fuori dall'Italia:

a) in caso di cessione intra-comunitaria, entro 45 (quarantacinque) giorni dalla ricezione dei Prodotti presso gli stabilimenti di CLIENTE, CLIENTE dovrà trasmettere a VENDITORE un originale o una copia del documento di trasporto internazionale CMR o di altro documento di trasporto, sottoscritti a destinazione da CLIENTE ovvero, in assenza del CMR, una dichiarazione di ricezione dei Prodotti, emessa sulla base del form quale Allegato -1- disponibile per il download all'indirizzo www.panariagroup.it;

b) in caso di cessione extra-comunitaria, CLIENTE si impegna a:

- i) presentare la dichiarazione doganale di esportazione (DAU-EX e DAE) ed effettuare l'appuntamento del MRN (Movement Reference Number) presso la dogana del territorio comunitario di uscita dei Prodotti, entro 90 (novanta) giorni dalla data di consegna in Italia dei Prodotti stessi;
- ii) inviare a VENDITORE, entro 90 (novanta) giorni dalla data di consegna, i documenti comprovanti l'esportazione dei Prodotti (dichiarazione di esportazione DAU-EX + DAE + notifica di avvenuta esportazione);
- iii) confermare prontamente per iscritto a VENDITORE l'avvenuta esecuzione delle suddette formalità e a

fornirgli ogni ulteriore documento comprovante l'esecuzione delle suddette formalità e l'uscita dei Prodotti dal territorio dell'Unione Europea.

In caso di inadempienza di CLIENTE a quanto pattuito al presente paragrafo 4.2, VENDITORE avrà il diritto di addebitare immediatamente a CLIENTE l'Imposta sul Valore Aggiunto relativa alla fornitura e connessa alla mancata prova del trasporto dei Prodotti in altro Stato Membro della Comunità Europea o mancato appuramento della esportazione. In ogni caso, CLIENTE terrà indenne e manlevato VENDITORE in relazione al pagamento di tutto quanto eventualmente dovuto da VENDITORE nei confronti dell'Amministrazione Finanziaria, a titolo di sanzioni ed interessi o ad altro titolo, in connessione con la fornitura e la mancata prova del trasporto dei Prodotti in altro Stato Membro della Comunità Europea o al mancato appuramento della esportazione.

A tal proposito, VENDITORE potrà: (i) compensare qualsiasi importo dovuto da CLIENTE in base al presente paragrafo 4.2 con eventuali crediti maturati da CLIENTE, a qualsiasi titolo, nei confronti di VENDITORE: ovvero (ii) trattene definitivamente eventuali somme già ricevute da CLIENTE in relazione a Contratti di Vendita ancora da eseguirsi, effettuando una compensazione fra il debito di CLIENTE in base al presente paragrafo 4.2 e tutti i pagamenti già eseguiti da CLIENTE.

4.3 VENDITORE eseguirà la consegna dei Prodotti entro il termine previsto nel Contratto di Vendita, anche mediante consegne parziali. Il termine di consegna si intenderà in ogni caso non essenziale né perentorio. Salvo il caso di dolo o colpa grave, VENDITORE non sarà tenuto a corrispondere a CLIENTE alcun indennizzo o risarcimento per eventuali danni diretti o indiretti dovuti al ritardo nella consegna. In nessun caso di ritardo nella consegna dei Prodotti CLIENTE avrà il diritto di risolvere il Contratto di Vendita.

4.4 Al momento della ricezione dei Prodotti, CLIENTE avrà l'onere di denunciare danneggiamenti agli imballi e/o eventuali avarie o ammanchi di Prodotti verificatisi durante il trasporto, mediante apposizione di riserva scritta nel documento di trasporto, nonché l'onere di:

a) far confermare dal vettore, mediate apposita sottoscrizione, l'apposizione della riserva; e
b) informare immediatamente per iscritto VENDITORE e inviargli copia del suddetto documento entro e non oltre 8 (otto) giorni dalla data di ricezione dei Prodotti.

In caso contrario, VENDITORE non sarà responsabile per eventuali danneggiamenti, perdite o furti occorsi ai Prodotti durante il trasporto, anche qualora lo stesso sia eseguito con rischio in tutto o in parte a carico di VENDITORE.

5) Prezzi – Pagamento – Ritardato pagamento

5.1 I Prodotti verranno forniti ai prezzi concordati tra le parti nel Contratto di Vendita o, qualora il Contratto di Vendita non dovesse menzionare alcun prezzo, ai prezzi riportati nel listino prezzi di VENDITORE in vigore al momento della conclusione del Contratto di Vendita. Salvo diversa indicazione scritta, i prezzi dei Prodotti riportati nei listini, nei preventivi e/o nelle offerte di VENDITORE si intendono in Euro, al netto di IVA e per consegne eseguite in conformità alla regola Incoterms® Ex-Works (EXW), stabilimento di VENDITORE indicato nel Contratto di Vendita, ICC, ultima versione. Pertanto, nel caso in cui venga convenuto un diverso termine di resa, l'importo della fattura verrà modificato di conseguenza, includendo in fattura le spese di trasporto e ogni altro onere connesso con il termine di resa concordato tra le parti per la consegna dei Prodotti.

5.2 Il pagamento dei Prodotti dovrà essere eseguito da CLIENTE con le modalità e nei tempi indicati nel Contratto di Vendita o diversamente concordati per iscritto tra le parti. I pagamenti si considereranno effettuati da CLIENTE solo nel momento in cui il relativo importo sarà stato accreditato sul conto corrente di VENDITORE. Il pagamento dovrà essere effettuato da CLIENTE in Euro ovvero nella valuta del luogo in cui CLIENTE ha la propria sede, a scelta di VENDITORE, in conformità alla valuta che VENDITORE indicherà nella relativa fattura di vendita.

5.3 Nel caso in cui CLIENTE sia in ritardo nell'esecuzione del pagamento, VENDITORE avrà diritto:

a) al pagamento degli interessi legali di mora, in conformità alla legge applicabile;
b) di sospendere le consegne ancora da eseguirsi, previa comunicazione scritta a CLIENTE, fino a quando gli importi dovuti e i relativi interessi di mora siano stati integralmente pagati.

5.4 Qualora tali importi e interessi risultino ancora non pagati una volta decorsi 30 (trenta) giorni dalla scadenza data di pagamento concordata, VENDITORE potrà altresì, a propria discrezione, alternativamente o cumulativamente, e in aggiunta a qualsiasi altro diritto o rimedio allo stesso spettante in base alla legge o alle presenti CGV:

a) esigere l'immediato pagamento di ogni debito residuo, anche se sia stato convenuto un pagamento a rate o un pagamento dilazionato e/o siano stati emessi e siano in scadenza cambiali tratte, pagherò cambiari, assegni o altri strumenti di pagamento;

b) risolvere il Contratto di Vendita in questione e trattene definitivamente eventuali somme già ricevute in relazione a tale Contratto di Vendita e/o ad altri Contratti di Vendita, effettuando una compensazione fra il debito di CLIENTE e tutti i pagamenti ricevuti;

c) eseguire le future consegne dei Prodotti soltanto previo pagamento anticipato in relazione alle forniture ancora da eseguirsi;

d) revocare sconti e bonus che siano stati concordati fra le parti anche in relazione a Contratti di Vendita regolarmente eseguiti.

5.5 I diritti di cui ai precedenti paragrafi 5.3 e 5.4 potranno essere esercitati in qualsiasi momento da VENDITORE anche nel caso in cui:

a) CLIENTE sia sottoposto a liquidazione, a procedure concorsuali, fallimentari, di ristrutturazione del debito o ad azioni esecutive; oppure
b) la compagnia assicurativa di VENDITORE rifiuti la copertura assicurativa di crediti di VENDITORE nei confronti di CLIENTE; oppure

c) CLIENTE versi in uno stato di difficoltà finanziaria idoneo a determinare un pregiudizio al puntuale adempimento dei propri obblighi di pagamento - risultante, a titolo esemplificativo e non esaustivo, dalla levata di protesti, dalla diminuzione di garanzie concesse e/o dalla mancata prestazione di garanzie promesse, nonché dal verificarsi di qualsiasi insoluto, anche qualora tali circostanze si siano verificate nell'ambito dei rapporti tra CLIENTE ed altri suoi fornitori.

5.6 CLIENTE non potrà far valere eventuali inadempimenti di VENDITORE né potrà avviare alcuna azione legale nei confronti dello stesso fino a quando non abbia pagato integralmente a VENDITORE ogni importo allo stesso spettante ai sensi dei paragrafi 5.3 e 5.4.

6) Riserva di Proprietà

6.1 VENDITORE manterrà la proprietà dei Prodotti venduti fino al completo pagamento del loro prezzo da parte di CLIENTE.

Fermo restando quanto sopra, il rischio di perimento dei Prodotti sarà disciplinato dal termine di resa Incoterms® concordato tra le parti per la consegna dei Prodotti. 6.2 In caso di inadempimento o ritardo nell'adempimento dell'obbligazione di pagare il prezzo dei Prodotti, fermo restando quanto previsto ai precedenti paragrafi 5.4, 5.5 e 5.6, VENDITORE avrà il diritto di accedere ai locali in cui si trovano i Prodotti, di rientrarne in possesso e di incamerare definitivamente, a titolo di penale, eventuali somme pagate da CLIENTE per i Prodotti in questione.

7) Garanzia

7.1 Fatto salvo quanto previsto ai precedenti paragrafi 2.1, 2.2, 2.4 e 3.6 in relazione alle modifiche ammesse ai Prodotti e alle tolleranze, VENDITORE garantisce a CLIENTE che i Prodotti saranno conformi al Contratto di Vendita, alla classificazione indicata nei manuali tecnici, cataloghi e/o listini prezzi di VENDITORE nonché privi di difetti di fabbricazione. La presente garanzia avrà la durata di 12 (dodici) mesi dalla data di ritiro dei Prodotti dallo stabilimento di VENDITORE, a prescindere dal termine di resa Incoterms® concordato.

7.2 Sono esclusi da qualsiasi garanzia:

- a) le alterazioni cromatiche e le differenze di tonalità dei Prodotti;
- b) i Prodotti classificati nel Contratto di Vendita come di qualità inferiore alla prima scelta ovvero come partite di Prodotti di fine serie venduta in blocco ovvero come partite speciali;
- c) i Prodotti non posati a regola d'arte e/o posati in modo difforme rispetto alle previsioni delle norme di settore applicabili;
- d) i Prodotti applicati su superfici e/o in ambienti diversi da quelli consigliati da VENDITORE;
- e) i Prodotti utilizzati in modo difforme rispetto alle istruzioni e/o indicazioni di VENDITORE incluse nei ca-

taloghi e/o i listini di VENDITORE ovvero in altro modo comunicate a CLIENTE da VENDITORE ivi incluse le indicazioni di cui al precedente paragrafo 2.2;

f) i Prodotti utilizzati in modo non conforme alla normale diligenza e/o alla tecnica richieste dalla natura dei Prodotti stessi;

g) l'ingelività del Prodotto, a meno che tale caratteristica del Prodotto non sia stata dichiarata da VENDITORE nel manuale tecnico, in riferimento al Prodotto in questione;

h) caratteristiche dei Prodotti come risultanti dalla classificazione del materiale ceramico (I) eseguita da parte di organismi di controllo e/o certificazione diversi da quelli di Paesi dell'Unione Europea e/o (ii) effettuata sulla base di criteri che non corrispondano a quelli utilizzati da VENDITORE.

7.3 Fermo quanto previsto al precedente paragrafo 4.4, CLIENTE sarà tenuto ad esaminare i Prodotti nel più breve tempo possibile e, a pena di decadenza dalla presente garanzia, a denunciare per iscritto a VENDITORE, a mezzo fax o email:

a) difformità relative alla tipologia e/o alla quantità dei Prodotti ricevuti nonché altre difformità palesi dei Prodotti o loro difetti palesi: entro e non oltre 8 (otto) giorni dalla consegna dei Prodotti e, comunque, prima della posa in opera dei Prodotti;

b) difformità occulte o difetti occulti dei Prodotti: entro e non oltre 8 (otto) giorni dalla scoperta e, comunque, entro il periodo di garanzia.

7.4 VENDITORE avrà il diritto di verificare i Prodotti, o alcuni campioni dei Prodotti, che CLIENTE ritenga essere difformi o difettosi, anche al fine di verificare il rispetto delle prescrizioni relative alla posa in opera degli stessi e/o all'applicazione e/o all'utilizzo dei Prodotti come rinvenibili dalle presenti CGV. A tale proposito, CLIENTE potrà restituire a VENDITORE i Prodotti dallo stesso ritenuti difformi o difettosi soltanto previa autorizzazione scritta di VENDITORE ed a condizione che CLIENTE si faccia integralmente carico delle spese e dei rischi di spedizione. L'autorizzazione al reso dei Prodotti o dei campioni asseritamente difformi o difettosi non costituirà in nessun caso riconoscimento delle difformità o dei difetti da parte di VENDITORE.

7.5 Nel caso in cui i Prodotti siano riconosciuti da VENDITORE come effettivamente difformi o difettosi, CLIENTE, a scelta di VENDITORE, avrà esclusivamente diritto:

a) alla sostituzione gratuita dei Prodotti difformi o difettosi; oppure
b) all'esonazione parziale o totale dal pagamento del loro prezzo, a seconda della gravità delle difformità o dei difetti.

7.6 Ai fini del paragrafo 7.5 lettera (a), i Prodotti che debbano essere consegnati in sostituzione di Prodotti difformi o difettosi saranno consegnati a CLIENTE in conformità alla regola Incoterms® 2010 ICC DDP – stabilimento di CLIENTE. I Prodotti che siano stati sostituiti dovranno essere, a scelta di VENDITORE, distrutti o smaltiti da CLIENTE, a spese di quest'ultimo, ovvero restituiti a VENDITORE, a spese di VENDITORE stesso. Per i Prodotti sostituiti che debbano essere distrutti o smaltiti da CLIENTE, CLIENTE si impegna ad inviare a VENDITORE la prova dell'avvenuta distruzione o smaltimento dei Prodotti, unitamente ai documenti giustificativi comprovanti il sostenimento dei costi di distruzione o smaltimento.

7.7 I diritti e rimedi descritti ai precedenti paragrafi 7.5 e 7.6 costituiscono i soli diritti e rimedi in garanzia concessi a CLIENTE. Nella massima misura consentita dalla legge, sono esclusi ulteriori responsabilità o obblighi di VENDITORE in relazione alla fornitura di Prodotti difformi o difettosi, ivi inclusi, a titolo esemplificativo e non esaustivo, responsabilità e obblighi per eventuali danni diretti, indiretti o consequenziali, perdite di profitto, ecc. a cui tale responsabilità si ricollega.

7.8 La presente garanzia sostituisce ed esclude ogni altra garanzia, espressa o implicita, prevista per legge o altrimenti.

8) Forza maggiore

8.1 VENDITORE non sarà in alcun modo responsabile per il mancato o ritardato adempimento di alcuna obbligazione relativa alla fornitura dei Prodotti qualora tale mancato o ritardato adempimento sia dovuto a eventi di forza maggiore come guerre, incendi, terremoti, inondazioni, tsunami, scioperi, difficoltà insorte con la forza lavoro, scarsità o difficoltà di approvvigionamento di materie prime, restrizioni all'uso di energia, sospensione o difficoltà nei trasporti, guasti agli impianti, atti della

pubblica autorità o a qualsiasi altra azione o causa che non possa essere ragionevolmente prevista o alla quale VENDITORE non possa ragionevolmente porre rimedio tramite l'ordinaria diligenza.

8.2 In tali eventualità, il termine per l'esecuzione della fornitura verrà esteso per tutto il periodo di durata dell'evento di forza maggiore, fermo restando che, qualora tale evento dovesse impedire l'esecuzione della fornitura per oltre 6 (sei) mesi, CLIENTE avrà il diritto di risolvere il relativo contratto di vendita, mediante invio di lettera raccomandata con ricevuta di ritorno o corriere a VENDITORE, senza alcuna responsabilità o conseguenza per VENDITORE.

9) Invalidità di singole clausole contrattuali

L'invalidità di una disposizione delle presenti CGV non comprometterà la validità delle residue disposizioni che rimarranno pienamente valide e efficaci.

10) Riservatezza

10.1 CLIENTE si impegna a: (i) trattare come riservati tutte le informazioni/dati/disegni/know-how/documentazione trasmessigli da VENDITORE ovvero di cui sia venuto a conoscenza nell'esecuzione dei singoli Contratti di Vendita, indipendentemente dal fatto che tali informazioni siano o meno contrassegnate o identificate come riservate o confidenziali ("Informazioni Riservate"); (ii) non divulgare e non comunicare a terzi, né in tutto né in parte, le Informazioni Riservate senza il preventivo consenso scritto di VENDITORE; (iii) limitare l'utilizzo di tali Informazioni Riservate ed il relativo accesso per scopi relativi all'esecuzione dei singoli Contratti di Vendita; (iv) adottare tutte le misure necessarie al fine di assicurare che i propri dipendenti e i propri collaboratori evitino di divulgare a terzi le Informazioni Riservate o le utilizzino in modo improprio. Le Informazioni Riservate non potranno essere riprodotte senza previo consenso scritto di VENDITORE, e tutte le copie delle stesse saranno immediatamente restituite dietro richiesta di VENDITORE.

10.2 Le previsioni di cui sopra non si applicano alle informazioni che: (i) sono pubbliche o divengono pubbliche non per divulgazione da parte del CLIENTE, dei suoi dipendenti o collaboratori, o (ii) erano in possesso del CLIENTE prima che le ricevesse da VENDITORE o (iii) sono state divulgate da fonti che non sono sottoposte alle restrizioni cui è sottoposto CLIENTE relativamente al loro utilizzo, o (iv) possono essere divulgate a terzi in base ad un'autorizzazione scritta di VENDITORE.

11) Legge applicabile - Risoluzione delle controversie

11.1 Le presenti CGV e tutti i Contratti di Vendita che le parti stipuleranno in base alle presenti CGV saranno regolati dalla Convenzione di Vienna del 1980 sulla vendita internazionale di merci e, nelle materie non coperte da tale Convenzione, dalla legge italiana.

11.2 Qualsiasi controversia relativa alle presenti CGV e/o ai Contratti di Vendita che interverranno sulla base delle stesse sarà decisa in conformità alle seguenti previsioni:

a) qualora CLIENTE abbia la sua sede legale nell'Unione Europea, in Svizzera, in Norvegia o in Islanda, la controversia sarà assoggettata in via esclusiva alla giurisdizione italiana e, in relazione ad essa, sarà esclusivamente competente il Tribunale di Modena (Italia);

b) in tutti gli altri casi, la controversia sarà decisa in via esclusiva e definitiva mediante arbitrato, celebrato da un arbitro unico, in conformità al Regolamento di Procedura della Camera Arbitrale di Milano.

L'arbitrato avrà sede, e il lodo arbitrale verrà pronunciato, nella città di Milano (Italia). La lingua dell'arbitrato sarà la lingua inglese.

11.3 È tuttavia concesso, unicamente a favore di VENDITORE, il diritto incondizionato di agire, in qualità di attore, sotto la giurisdizione di CLIENTE innanzi al tribunale competente.

12) Lingua delle CGV

12.1 Il testo delle presenti CGV è redatto sia in lingua italiana che in lingua inglese. In caso di discrepanza, il testo in lingua italiana prevarrà sul testo in lingua inglese.

Le presenti condizioni generali di vendita sono pubblicate e scaricabili sul sito internet www.panariagroup.it

GENERAL TERMS AND CONDITIONS OF SALE

1) Scope Of Application

1.1 These General Terms and Conditions of Sale ("General Conditions") shall apply to any and all supply of ceramic tiles or other ceramic products ("Products") that will be executed to any client ("CLIENT") from any company or division of the Group Panariagroup Industrie Ceramiche S.p.A. ("SELLER"), even if these General Conditions are not expressly referred to, mentioned or expressly accepted by the CLIENT from time to time.

1.2 No provisions deviating from these General Conditions shall be binding on SELLER unless (i) included in the "Sale Contract", as defined under paragraph 3.2 below, (ii) included in documents following the Sale Contract and the content of the same has been accepted in writing by SELLER. In any case, even if deviating provisions are agreed upon, these General Conditions shall apply for the parts not expressly disregarded.

1.3 In no case shall any general conditions of contract of CLIENT be binding on SELLER, even if mentioned or included in orders or in any other documents transmitted by CLIENT to SELLER. No conduct of SELLER shall be interpreted or used in order to express tacit acceptance of SELLER to the general conditions of contract of CLIENT.

1.4 In no case SELLER shall be bound by acts and/or conducts of its agents, being the latter in lack of any power to bind SELLER.

1.5 In case CLIENT is a consumer, the provisions of these General Conditions shall not prejudice the rights of CLIENT provided for by the law applicable to sales executed toward consumers.

2) Products – Modifications

2.1 Any representation and/or image relating to the Products included in websites, brochures, catalogues, price lists or other similar documents of SELLER is approximate and purely illustrative. As a consequence, such representations and/or images do not represent the final aesthetic result of the Products. Technical and physical characteristics of the Products as well as qualities of the same are described in the technical manuals of SELLER only. Any other document including technical and physical characteristics and qualities of the Products are purely indicative and shall not bind SELLER.

2.2 SELLER declares that the Products are compliant with the applicable Italian and European industry standards. Any Products shall be used and applied in accordance with the instructions of use of SELLER included in catalogues and/or technical manuals of SELLER with reference to the Products in question or with the instructions in other way communicated and/or made available by SELLER to CLIENT and, in any case, in accordance with the diligence required by the nature of the Products. Failing to do so, CLIENT will result in the lapse of the warranty and in the unenforceability of the warranty rights under article 7 below or of any other legal or agreed warranty.

2.3 It is the responsibility of CLIENT, before executing of the Sale Contract, to make sure that the Products are suitable for their specific purpose and/or intended use and, in addition, that they also comply with the laws and regulations applicable in the place where CLIENT will import, distribute, sell or use them in any way.

2.4 SELLER may make any changes to the Products which, without altering their essential features, it deems necessary or convenient, even after execution of the Sale Contract. In case SELLER executes substantial modification to Products (e.g. modifications that will alter: the way of installation, characteristic of interchangeability of the Products, etc.) which are the object of an executed Sale Contract (as defined in paragraph 3.2 below), SELLER shall communicate in writing such modification to CLIENT.

2.5 CLIENT shall inform the purchasers of the Products and third parties of the characteristics of the Products and of the instructions of use and of application of the same in accordance with the indication provided by SELLER. Without prejudice to the above, CLIENT shall be the sole responsible and liable for the declarations it will make toward third parties with reference to the Products, their characteristics and their use or application and shall indemnify and hold SELLER harmless and from any damage possibly suffered by SELLER with reference to or in connection to such declarations of CLIENT, in case they result false, incomplete or inaccurate.

3) Quotations – Execution of Sale Contract – Tolerances

ces

3.1 Written or verbal quotations issued by SELLER are not to be taken as valid contractual proposals.

3.2 The sale contract ("Sale Contract") is executed as follows:

a) an offer is sent by SELLER to CLIENT and CLIENT then sends its written acceptance of such offer to SELLER, without any modification to the offer itself; or
b) a purchase order is sent by CLIENT and SELLER then sends its written acceptance of such order to CLIENT.

3.3 For the purposes of paragraph 3.2 letter a) above, the following facts or actions shall constitute the written acceptance of an offer of SELLER by CLIENT:

a) the receipt by SELLER of a letter of credit sent by CLIENT;
b) the receipt by SELLER of all or part of the relevant purchase price;

c) the receipt by SELLER of a purchase order of CLIENT. Should this be the case, any order of CLIENT that differs from the provisions of the offer of SELLER shall be binding on SELLER only if and to the extent that SELLER had expressly accepted it in writing.

3.4 In addition, for the purposes of paragraph 3.2 letter b) above, in case the acceptance of SELLER includes terms and condition different from those of the order of CLIENT, the Sale Contract shall be deemed to be concluded at the conditions included in the acceptance of SELLER, unless CLIENT notifies SELLER, in writing, not to accept the terms and conditions of the acceptance of SELLER within 1 (one) working day from the receipt of such acceptance.

3.5 All supplies of Products will only include what is expressly indicated in Sale Contract.

3.6 CLIENT recognizes to SELLER quantity and quality tolerances as resulting from the Sale Contract or from the usage and practices of the sector of the Products.

4) Packing – Delivery term – Delivery time

4.1 The Products will be packaged and readied to ship in compliance with the standard protection methods generally adopted by SELLER for the Products in question, in consideration of the agreed mode of transport.

CLIENT shall expressly request to SELLER any special packaging or supplementary protection it deems necessary, and in such event CLIENT will bear all related costs thereof.

4.2 Unless otherwise provided for in the Sale Contract, the Products shall be delivered to CLIENT in accordance with the Incoterms® ICC rule, latest version, Ex-Works (EXW) – premises of SELLER indicated in the Sale Contract.

CLIENT authorizes SELLER to undersign, in the name and on behalf of CLIENT, any and all transport documents which shall be signed at the time of collection of the Products at the premises of SELLER, such as the CMR. In the event that the ICC Incoterms® rule agreed between the parties provides that CLIENT shall take care of the transportation of the Products outside the territory of Italy:

a) in case of an Intra-EU supply, within 45 (forty-five) days from the receipt of the Products at its premises, CLIENT shall send SELLER an original or a copy of the international transportation document CMR or of another transportation document, undersigned at destination by CLIENT or, in the absence of the international transportation document CMR, a declaration of receipt of the Products issued on the basis of the form as Annex -1- available for download at www.panariagroup.it;

b) in case of an Extra-EU supply, CLIENT shall:
i) submit the custom export declaration (SAD-EX + EAD) and execute the validation of the MRN (Movement Reference Number) at the customs of the UE territory of exit of the Products, within 90 (ninety) days from the date of delivery of the same in Italy;
ii) send SELLER, within 90 (ninety) days from the date of delivery, documents proving the exportation of the Products (custom export declaration SAD-EX + EAD + certification of exit);

iii) notify SELLER, in writing, as soon as such submission is accomplished and provide SELLER with any other document proving the execution of such formalities as well as the exit of the Products from the UE Territory.

In case CLIENT is in breach of its obligations under this paragraph 4.2, SELLER shall be entitled to immediately

charge CLIENT the amount of the Value Added Tax applicable to the supply and connected to the lack of proof of the transportation of the Products in a another Member State of the EU or to the lack of execution of custom clearance formalities. In any case, CLIENT shall indemnify and hold SELLER harmless with reference to any payment due to tax offices for fines, interests or on any other basis, in connection with the supply and with the lack of the proof of the transportation of the Products in a another Member State of the EU or with the lack of execution of custom clearance formalities.

In this respect, SELLER shall be entitled to: (i) offset any amount due by CLIENT on the basis of this paragraph 4.2 against any amount due, for whatever reason, from SELLER to CLIENT; or (ii) definitively withhold any amount received in regard to Sale Contracts, offsetting the CLIENT's debt under this paragraph 4.2 against any and all sums already paid by CLIENT.

4.3 SELLER shall deliver the Products within the delivery date provided for in the Sale Contract, in a single delivery or in partial deliveries. The delivery date shall always be considered neither of the essence nor peremptory. Except in case of wilful wrongdoing or gross negligence, SELLER will not reimburse possible damages, either direct or indirect, suffered by CLIENT as a result of delay in the delivery of the Products.

In no case of delay in the delivery of the Products shall CLIENT be entitled to terminate the Sale Contract.

4.4 Upon receipt of the Products, CLIENT must report possible damages occurred to the packaging and/or shortages or anomalies of the Products occurred during the transport, by notifying details of such events on the transportation document, and must also:

a) have such notification countersigned by the carrier;
b) immediately inform SELLER thereof, in writing, and send SELLER a copy of the countersigned document by and no later than 8 (eight) day(s) from the date of receipt of the Products.

Should this not be the case, SELLER shall not be responsible for possible damages losses or theft of the Products occurred during the transport, even if transport risks were, in whole or in part, upon SELLER.

5) Prices – Payment – Late Payment

5.1 The Products shall be supplied at the prices agreed between the parties in the Sale Contract or, should no prices be mentioned in the Sale Contract, at the prices resulting from the price list of SELLER in force when the Sale Contract has been executed. Unless otherwise stated in writing, the prices of the Products included in SELLER's price lists, quotations and/or offers are in Euro, net of VAT and for delivery according to the Incoterms® ICC rule, latest version, Ex-Works (EXW) - premises of SELLER indicated in the Sale Contract. Therefore, should a different Incoterms® rule be agreed upon between the parties for the delivery of the Products, the invoiced amount shall be modified accordingly, including in the sale invoice transportation expenses and any other costs connected with the Incoterms® rule agreed between for delivery.

5.2 CLIENT shall pay for the Products in accordance with the payments methods and terms provided for in the Sale Contract or otherwise agreed upon in writing between the parties. No payment shall be considered as being made by CLIENT until the relative amount has been credited to the bank account of SELLER.

Payment shall be executed by CLIENT in Euro or in the currency of the place where CLIENT has its registered office, at SELLER's discretion, in accordance with the currency indicated by SELLER in the related sale invoice.

5.3 If CLIENT is delinquent in its payment obligation, SELLER may:
a) obtain payment of late payment interest in accordance with the applicable law;
b) withhold ongoing and future deliveries, upon written notice to CLIENT, until all delinquent amounts and late payment interest are fully paid.

5.4 If delinquent amounts and late payment interest remain unpaid 30 (thirty) days after the agreed deadline for payment, then SELLER may also, at its option, alternatively or cumulatively, and in addition to any other right or remedy available at law or pursuant to these General Conditions:

a) request accelerated payment of any and all remaining payments and declare due the total outstanding balan-

ce, even if payment by instalment or deferred payment has been agreed upon and/or bills of exchange, promissory notes, cheques or other payment documents have been issued and are falling due;

b) terminate the Sale Contract in question and definitively withhold any amount received in regard to such Sale Contract or to other Sale Contracts, offsetting the CLIENT's outstanding debt against any and all sums already paid by CLIENT;

c) carry out future deliveries of Products on a pre-payment basis only, also with reference to supplies still to be executed;

d) cancel discounts and bonuses that may have been agreed between the parties also with reference to Sale Contracts already regularly executed.

5.5 SELLER shall be entitled to exercise the rights mentioned in paragraphs 5.3 and 5.4 above also in case:

a) CLIENT is undergoing winding-up, bankruptcy, debt restructuring or enforcement proceedings;
b) the insurance company of SELLER refuses insurance coverage for SELLER's credits toward CLIENT;

c) CLIENT is undergoing financial difficulties able to hinder the regular execution of its payment obligations resulting from, by way of example only, missed payment of bills of exchange, promissory notes, cheques or other payment documents, reduction of granted guarantees and/or missed granting of promised guarantees, as well as from any amount resulting unpaid, even though such circumstances have occurred with other suppliers of CLIENT.

5.6 CLIENT cannot claim any breach of contract by SELLER, nor can CLIENT start any lawsuit or action against SELLER, until any amount resulting due to SELLER under paragraphs 5.3 and 5.4 above has been paid in full by CLIENT.

6) Retention of Title

6.1 SELLER will maintain exclusive ownership over the Products sold until their price has been entirely paid by CLIENT.

Without prejudice to the above the risks of loss of the Products shall be regulated by the Incoterms® rule agreed between the parties for the delivery of the Products.

6.2 In case of non-fulfilment or late fulfilment of the obligation to pay the price of the Products, without prejudice to the rights under paragraphs 5.4, 5.5 and 5.6, SELLER shall be entitled to enter the premises where the Products are held, re-possess the Products and withhold, as liquidated damages, any amount already paid by CLIENT with reference to such Products.

7) Warranty

7.1 Without prejudice to the provisions of paragraphs 2.1, 2.2, 2.4 and 3.6 with reference to the modifications to the Products and tolerances, SELLER warrants that the Products will conform to the Sale Contract, to the classification indicated in the technical manuals, catalogues and/or price lists of SELLER and that they will be free from manufacturing defects.

The warranty period is 12 (twelve) months from the date of collection of the Products from the premises of SELLER, regardless of the agreed Incoterms® rule for delivery.

7.2 The following are expressly excluded from warranty:
a) chromatic alterations and tone differences of the Products;

b) the Products identified in the Sale Contract as Products of quality lower than first-quality Products or as close-out sale Products or as special batches;

c) the Products applied and/or set up not in compliance with the industry standards applicable to the same;

d) the Products used or applied on surfaces and/or in spaces or environments different from those indicated by SELLER;

e) the Products used not in compliance with the instructions and/or indications provided by SELLER included in the catalogues and price lists of SELLER or in other way communicated to CLIENT by SELLER, included the instructions under paragraph 2.2;

f) the Products used not in compliance to the standard diligence and/or to the technics required by the nature of the Products;

g) frost resistance of the Products, unless such characteristic of the Products has been declared by SELLER in the technical manual of the Products;

h) characteristics of the Products as resulting from the

classification of the pottery (i) executed by control and/or certification authorities other than authorities of the European Union Member States, and/or (ii) executed on the basis of criteria other than those used by SELLER.

7.3 Without prejudice to the provisions of paragraph 4.4 above, CLIENT shall inspect the Products as soon as possible and shall notify SELLER in writing of possible non-conformities or defects, by fax or email, within and no later than the following terms; failing to do so will result in the lapse of the warranty and the unenforceability of the warranty rights:

a) differences in type or quantity with respect to type or quantity agreed as well as other patent non-conformities or defects of the Products: 8 (eight) days from the delivery of the Products at the premises of CLIENT and, in any case, before application of the Products;

b) hidden non-conformities or defects of the Products: 8 (eight) days from the discovery of the same and, for avoidance of doubt, within the warranty period.

7.4 SELLER will have the right to examine the Products, or samples of the Products, which CLIENT claims to be non-conforming or defective, in order to verify the instructions relating to the set up and/or application of the Products and/or the use of the Products in accordance with the provisions of these General Conditions.

In this respect, CLIENT shall be entitled to return to SELLER the Products that CLIENT considers to be non-conforming or defective only upon SELLER's written authorization and only on the condition that CLIENT bears all costs and risks for the shipment of the Products. The authorization to return the Products or samples of the purportedly non-conforming or defective Products shall never be interpreted as an acknowledgment of the claimed non-conformities or defects on the part of SELLER.

7.5 In case the Products are ascertained by SELLER as actually non-conforming or defective, CLIENT will be entitled only to obtain, at the SELLER's option:
a) replacement of the non-conforming or defective Products; or
b) partial or full exemption from payment of their price, depending on the seriousness of the non-conformities or of the defects.

7.6 For the purpose of paragraph 7.5 letter (a), the Products to be delivered in replacement of non-conforming or defective Products shall be delivered to CLIENT in accordance with the Incoterms® 2010 ICC rule DDP - premises of CLIENT. The Products that have been replaced shall be, at SELLER's discretion, destroyed or disposed of by CLIENT, at its own costs, or returned to SELLER, at costs of SELLER. In case the Products are to be destroyed or disposed of by CLIENT, CLIENT undertakes to send to SELLER the proof of destruction or of disposal of the Products, along with the documents proving the costs borne by CLIENT for the destruction or the disposal of the same.

7.7 The rights and remedies described in paragraphs 7.5 and 7.6 above are the sole warranty rights and remedies granted to CLIENT. To the maximum extent permitted by the applicable law, any other liability and obligation of SELLER, which may in any way arise from or in relation to the supply of non-conforming or defective Products - including, but not limited to, compensation for direct or indirect or consequential damages, loss of profits, etc. connected to such liability - is expressly excluded.

7.8 The present warranty is in substitution for, and excludes, any other warranty, express or implied, set forth by the law or otherwise.

8) Force Majeure

8.1 SELLER shall not be liable or responsible for failure or delay in performing or fulfilling any obligations undertaken in reference to the supply of Products when such failure or delay is due to the occurrence of an event of force majeure such as wars, fires, earthquakes, floods, tsunami, strikes, labor or employment difficulties, shortage or procurement difficulties of raw materials, restriction on the use of power, suspension or difficulties in the transports, breakdown of the plants, acts of public authorities or any other event or cause whatsoever, similar or dissimilar, which cannot reasonably be forecast or provided against and which cannot be overcome by SELLER with reasonable diligence.

8.2 In such event, the time for fulfilment of the obligation shall be extended for the period of continuance of such force majeure event.

In the event any of such force majeure event continue for a period longer than 6 (six) months, CLIENT shall have the right to terminate the underlying Sale Contract, by giving written notice to SELLER by registered letter with return receipt or courier, and SELLER shall not incur any responsibility or liability whatsoever.

9) Severability

The invalidity or unenforceability of any provision, or portion thereof, of this General Conditions shall not affect the validity or enforceability of any other provision.

10) Confidentiality

10.1 CLIENT undertakes: (i) to treat with the utmost confidentiality all the information/data/designs/know-how/documentation transmitted by SELLER or that it may come to know in connection with the execution of any Sale Contract, even if they are not marked or identified as secret or confidential ("Confidential Information"); (ii) not to, wholly or partially, disclose to or inform third parties of the Confidential Information, without the SELLER's prior written consent; (iii) to limit the use of the Confidential Information and the access to the same for purposes relating to the execution of the sale Contracts; (iv) to adopt any and all measures required in order for its employees and collaborators do not disclose the Confidential Information to third parties or use it in an inappropriate way.

The Confidential Information shall not be copied or reproduced in any way, unless with the prior written consent of SELLER, and all the copies of the Confidential Information shall be immediately returned to SELLER upon simple written request of the same.

10.2 The provisions above shall not apply to information which (i) are public or publicly available not due to a disclosure of CLIENT or of CLIENT's employees or collaborators; or (ii) were already available to CLIENT before it had received them by SELLER; or (iii) are disclosed from third parties that have no obligation of confidentiality or restrictions of use on the same; (iv) can be disclosed according to a written authorization of SELLER.

11) Applicable Law – Dispute Resolution

11.1 These General Conditions and all the Sale Contracts that will occur on the basis on the same will be governed by the United Nations Convention on Contracts for the International Sale of Goods (Vienna Convention of 1980) and, with respect to matters not covered by such Convention, by Italian laws.

11.2 Any dispute arising out of or in connection with these General Conditions or in connection with a Sale Contract occurred on the basis on the same shall be settled in accordance with the following provisions:

a) In case CLIENT has its registered office within the European Union, in Switzerland, in Norway or in Iceland, the dispute shall be subjected to the jurisdiction of the Italian courts and shall be exclusively referred for its resolution to the Court of Modena (Italy). b) In any other case, the dispute shall be exclusively referred to and finally resolved by arbitration, by a sole arbitrator, in accordance with the Rules of the Milan Chamber of Arbitration (the Rules).

The seat of arbitration shall be, and the award shall be delivered in, Milan (Italy).

The language to be used in the arbitral proceedings shall be English.

11.3 Irrespective of the provisions above, it is hereby granted exclusively to SELLER the right to initiate legal proceedings under the jurisdiction of CLIENT before the competent court.

12) Language of these General Conditions

12.1 The text of these General Conditions is executed in both in Italian and in English language. In case of any discrepancy, the text in Italian shall prevail over the text in English language.

These general terms and conditions of sale are published and downloadable on the website www.panariagroup.it

FOLLOW US ON:



Art Direction & Graphic Design
Group Marketing & Communications Panariagroup

Febbraio 2019

COTTO D'ESTE[®] | LA
Nuove Superfici | BELLEZZA
IN
CERAMICA

Via Emilia Romagna, 31 41049 Sassuolo (MO) Italy
+39 0536 814 911 fax +39 0536 814 921
cottodeste.it - info@cottodeste.it
PANARIAGROUP INDUSTRIE CERAMICHE S.p.A.